

Tesis Doctoral
Ecología de Caulerpales: Fauna y
Biomarcadores

Autor: Antonio Box Centeno
Directora: Dra. Salud Deudero Company

Programa doctorado Ciencias Marinas
(Instituto Mediterráneo de Estudios
Avanzados)

Universidad Islas Baleares
22-Julio-2008



TESIS DOCTORAL

Ecología de Caulerpales: Fauna y Biomarcadores

Tesis doctoral presentada por Antonio Box Centeno para optar al título de doctor del programa en Ciencias Marinas de la Universidad de las Islas Baleares, bajo la dirección de la Dra. Salud Deudero Company

Antonio Box Centeno

Palma, 30 de Mayo de 2008

Directora de la Tesis Doctoral

El interesado

Índice

Índice de la presente tesis doctoral

ÍNDICE	5
AGRADECIMIENTOS	7
ABREVIACIONES	9
CAPÍTULO 1: INTRODUCCIÓN GENERAL	11
1.1 Introducción general	13
1.2 Especies invasoras	15
1.2.1 Definición de especie invasora y problemática	15
1.2.2 Especies invasoras en el Mediterráneo y Baleares	21
1.3 Praderas de <i>Posidonia oceanica</i> , Caulerpales e invertebrados	23
1.4 Caulerpenina y biomarcadores de estrés oxidativo	29
1.4.1 Metabolitos secundarios, Caulerpenina	29
1.4.2 Estrés oxidativo	29
CAPÍTULO 2 : CAMBIOS EN LAS COMUNIDADES DE MOLUSCOS	35
2.1 Introducción al capítulo	37
2.2 A mollusc community associated with invasive <i>Caulerpa racemosa</i> in the Western Mediterranean shallow seagrass beds .	39
2.3 How different is the mollusc community between invasive <i>Caulerpa taxifolia</i> (Chlorophyta: Caulerpaceae) and established <i>Caulerpa prolifera</i> in shallow seagrass beds of the Western Mediterranean?	63
2.4 Resumen de las comunidades de moluscos	87
CAPÍTULO 3 : CAMBIOS EN LAS COMUNIDADES DE DECÁPODOS	91
3.1 Introducción al capítulo	93
3.2 Changes in decapod crustacean faunistic composition associated with the seagrass <i>Posidonia oceanica</i> (Delile) induced by the presence of invasive <i>Caulerpa</i> species	95
3.3 Resumen de las comunidades de decápodos	123
CAPÍTULO 4 : CAMBIOS EN LAS COMUNIDADES DE POLIQUETOS	125
4.1 Introducción al capítulo	127
4.2 Seagrass polychaete assemblages changes after invasion by <i>Caulerpa racemosa</i> var <i>cylindracea</i> : community structure and	

Índice

trophic guilds	129
4.3 Community structure and trophic guilds: Differences in seagrass polychaete assemblage between invasive <i>Caulerpa taxifolia</i> and established <i>C. prolifera</i>	155
4.4 Resumen de las comunidades de poliquetos	183
CAPÍTULO 5 CAMBIOS EN LAS COMUNIDADES DE INVERTEBRADOS. NUEVAS ESPECIES Y CITAS	187
5.1 Introducción al capítulo	189
5.2 Changes in the faunistic communities associated with the presence of green algae <i>Caulerpa</i>	191
5.3 A new species <i>Nuuanu</i> (Amphipoda: Gammaridea: Melitidae) from shallow sandy bottoms of the Balearic Islands (Western Mediterranean)	207
5.4 Occurrence of <i>Automate branchialis</i> (Holthuis & Gottlieb, 1959)(Decapoda, Alpheidae) in the Balearic Islands (Western Mediterranean)	225
5.5 Resumen de cambios en las comunidades de invertebrados .	233
CAPÍTULO 6 : CAULERPENINA Y DEFENSAS ANTIOXIDANTES	235
6.1 Introducción al capítulo	237
6.2 Seasonality of caulerpenyne contents in the native <i>Caulerpa prolifera</i> and the invasive <i>Caulerpa taxifolia</i> and <i>Caulerpa racemosa</i> var <i>cylindracea</i> in the Western Mediterranean	241
6.3 Enzymatic antioxidant response of a labrid fish (<i>Coris julis</i>) liver to environmental caulerpenyne	261
6.4 Reciprocal effects of caulerpenyne and intense herbivorism on the antioxidant response of <i>Bittium reticulatum</i> and <i>Caulerpa taxifolia</i>	279
6.5 Antioxidant response and caulerpenyne production of <i>Caulerpa taxifolia</i> (Vahl) C. Agardh epiphyted by the invasive algae <i>Lophocladia lallemandii</i> (Montagne)	297
6.6 Resumen de caulerpenina y defensas antioxidantes	313
CAPÍTULO 7 RECAPITULACIÓN DE RESULTADOS	319
REFERENCIAS BIBLIOGRÁFICAS	331

Agradecimientos

Agradecimientos

Nunca pensé que hacer una tesis doctoral implicase tanto trabajo, horas de lupa, tiempo de ordenador, ratos delante de un espectrofotómetro o el HPLC, horas y más horas. En el momento de presentar mi tesis doctoral no me puedo olvidar de todas aquellas personas que han puesto su tiempo a mi disposición, enseñándome y explicándome nuevos conceptos, ayudándome y dándome los medios para poder desarrollar mis ideas e inquietudes.

En primer lugar quiero agradecer a la Dra Salud Deudero el ofrecerme la posibilidad de trabajar dentro de su equipo y siempre buscar la forma de que pudiese continuar adelante con mi tesis. Además quiero agradecer su forma de incentivar y permitir el desarrollo de mis ideas en la presente tesis doctoral.

Agradecer la ayuda del Laboratorio de Biología Marina de la Universidad de las Islas Baleares y todas las personas que durante más o menos tiempo han desarrollado prácticas o se han iniciado en la investigación, ya que muchas de ellas han colaborado activamente en la separación de las muestras, su procesado y salidas de campo. He de dar gracias especialmente a Piluca Sarrirera, Andreu Blanco, Toni Frau, Pep Alòs, y Cristina Alonso entre otras muchas persona por su tiempo dedicación y ayuda.

A la Catedrática de la Universidad de las Islas Baleares Isabel Moreno toda su paciencia, consejos en momentos difíciles y ser la persona que me permitió entrar dentro del Laboratorio de Biología Marina.

La presente tesis doctoral está enmarcada dentro de dos proyectos de Plan Nacional, el proyecto CAULEXPAN (REN-2002-00701/MAR), MACROALGAS INVASORAS (CTM2005-01434/MAR). Ambos proyectos han suministrado los fondos necesarios para el desarrollo de la presente investigación. Por ello quiero agradecer a la Dr. Nuria Marbà (IP Caulexpan) como el Dr. Jorge Terrados (IP Macroalgas invasoras) el permitirme trabajar, aprender y colaborar activamente con ellos.

Al Dr. Antoni Sureda su colaboración directa conmigo a la hora de desarrollar y poner a punto las metodologías necesarias para evaluar la concentración de caulerpenina en las tres caulerpales y en la realización de los trabajos ecotoxicológicos para interpretar el efecto de la caulerpenina sobre invertebrados, vertebrados y algas.

Al Dr. Daniel Martín, investigador de CEAB gracias al cual aprendí a clasificar los poliquetos, me proporcionó la bibliografía necesaria, me dió unas clases intensivas y

Agradecimientos

particulares de clasificación de poliquetos y que continua ayudándome en la escritura de nuevas publicaciones.

Al Dr. Pere Abellò, investigador de ICM por su ayuda a la hora de clasificar todos los decápodos que encontré en las muestras de *Caulerpa* y *Posidonia*, me proporcionó bibliografía y continua ayudándome durante la escritura de nuevas publicaciones.

Al Dr. Antoni Pons, profesor titular de la UIB, sus ideas, su tiempo, su interés, las facilidades para trabajar con los miembros de su equipo y la accesibilidad y facilidades para utilizar toda la maquinaria necesaria para poder abarcar todos los temas bioquímicos.

Al Dr. Damià Jaume, investigador del IMEDEA el cual me ha puesto en contacto con colegas suyos para la clasificación de otros grupos taxonómicos y me ha ayudado a clasificar tanto anfípodos como isópodos.

Al Dr. Guillem Pons, profesor de la UIB experto en moluscos, su ayuda a la hora de clasificar los “bichos” de las muestras. Agradecerle también la oportunidad de realizar mi primera conferencia de invertebrados en *Caulerpa*.

Al Dr. Phillipe Amade por venir hasta Mallorca y poner a punto la técnica de cuantificación de caulerpenina además de proporcionarnos caulerpenina pura con la cual pudimos establecer la recta patrón.

Agradecer especialmente al Dr. Guillem Mateu-Vicens, Silvia Tejada, Felip Cirer y Teresa Marcos por su paciente lectura de los manuscritos y de la tesis, sus comentarios y aportaciones.

Agradecer a mis padres todo su apoyo incondicional durante mis años de doctorando, sus ánimos y ayuda en momentos duros y de dudas. Quiero agradecer también a mi futura esposa, Paqui, el apoyo y ánimos que me ha dado en los momentos de desanimo y que ha sacrificado muchas cosas viniendo a vivir conmigo. Quiero acordarme también de todas aquellas personas que han compartido parte de su vida conmigo haciendola más feliz y que ahora no están, muchas gracias a todos por todo lo que me habeis aportado.

Muchas gracias a todos

Abreviaciones

Abreviaciones usadas

ANOSIM	Analysis of Similarities, análisis de similitudes
ANOVA	Analysis of Variance, análisis de la varianza
BSA	Bovine stantadart albumina, estándar de albumina bovina
CAT	Catalasa
CDNB	1-Cloro-2,4-Dinitrobenceno
CF-IRMS	Continuous Flow Isotope Ratio Mass Spectrometry, espectrómetro de masas de flujo continuo
CYN	Caulerpenina
DW	Dry weight, peso seco
GPx	Glutación peroxidasa
GR	Glutación reductasa
GSH	Glutación reducido
GSH/GSSG	Ratio glutación oxidado/Glutación reducido
GSSG	Glutación oxidado
GST	Glutación-s-transferasa
H ₂ O ₂	Peróxido de hidrógeno
HCl	Ácido clorhídrico
HPLC	High precission liquid cromatography, cromatografía líquida de alta precisión
MDA	Malondialdehido
MDS	Multidimensional scaling, análisis multidimensional
NADPH	Nicotiamida-Adenina Dinucleotido fosfato
PLS	Peach leave Standart, estándar de hoja de viña
ROS	Reactive oxigen species, especies reactivas de oxígeno
SIMPER	Species contributions to similaity, contribución de las especies a la similaridad
WW	Wet weight, peso húmedo

Capítulo 1

INTRODUCCIÓN GENERAL

GENERAL INTRODUCTION

1. 1 Introducción general

Intentando responder la pregunta ¿Como cambian, se adaptan o desaparecen las especies de fauna al aparecer algas invasoras del género *Caulerpa*? La presente tesis doctoral reúne los trabajos realizados durante el período comprendido entre 2004-2008 con el objetivo de analizar la respuesta de la fauna de las praderas de *Posidonia oceanica*, principal productor primario del Mediterráneo, ante la introducción y desarrollo de algas del género *Caulerpa*.

Para la realización del presente trabajo se han combinado metodologías clásicas de estudio de bentos con metodologías más novedosas, como la aplicación de biomarcadores de estrés oxidativo e isótopos estables. Además de completarse un estudio de la evolución anual de concentración de caulerpenina, toxina propia de caulerpales, en las tres especies de *Caulerpa* presentes en el mar Mediterráneo.

La estructura del presente trabajo se ha dividido en 7 capítulos:

- Capítulo 1, introducción con tres apartados principales:
 - Especies invasoras.
 - Praderas de *Posidonia oceanica*, caulerpales e invertebrados.
 - Caulerpenina y biomarcadores de estrés oxidativo.
- Capítulos 2, 3, 4 y 5, resultados de los trabajos de faunística en caulerpales:
 - Cambios en las comunidades de moluscos.
 - Cambios en las comunidades de decápodos.
 - Cambios en las comunidades de poliquetos.
 - Cambios en la comunidad general.
- Capítulo 6, ciclo anual de concentración de caulerpenina en *Caulerpa* y aplicación de biomarcadores de estrés oxidativo en relación a la concentración del metabolito secundario caulerpenina.
- Capítulo 7, síntesis de los resultados más destacables obtenidos.

La estructura de cada capítulo consta de:

- Una introducción de los trabajos realizados.

- Una enumeración de los análisis realizados, acompañados de una breve descripción metodológica.
- Una relación de las publicaciones científicas en preparación, enviadas y/o aceptadas.
- Y finalmente, una síntesis de los principales resultados y conclusiones obtenidos en el capítulo.

1. 2 Especies invasoras

1.2.1 Definición de especie invasora y problemática

Una especie invasora se define como cualquier especie cuya translocación a un ambiente fuera de su área de distribución original, dentro de los tiempos históricos, ha sido debida a la acción del hombre (de modo intencionado o accidental) (Olenin and Leppakoski 1999) o a su dispersión activa a través de vías naturales (ej: Estrecho de Gibraltar) (Streftaris et al. 2005).

Las especies invasoras son un problema a escala global ya que constituyen una amenaza para la especies nativas (Boudouresque and Verlaque 2002). La introducción de una especie puede afectar a la fauna y flora nativa a nivel de:

- Introducción de nuevos depredadores.
- Competencia por los recursos con las especies nativas.
- Mezcla genética con especies nativas próximas.
- Dispersión de sus patógenos afectando a las especies locales.
- Desplazamiento de especies locales colonizando y cambiando su hábitat.

En el medio marino la presencia de especies invasoras es considerada como un tipo de contaminación en auge, con efectos negativos sobre el medio ambiente y la sociedad, por la presencia de organismos potencialmente peligrosos para la salud, y con impactos sobre la economía (Carlton and Geller 1993).

Los efectos negativos de la introducción de especies en el ecosistema han sido ampliamente estudiados (Streftaris and Zenetos 2006). Un ejemplo del potencial de impacto de las especies invasoras son los dinoflagelados, cuyos quistes transportados en aguas de lastre de embarcaciones son responsables de mareas rojas tóxicas, con importantes efectos sobre las pesquerías y la salud humana (Ruiz et al. 1997).

Sin embargo, no siempre los ejemplos de introducción de especies son considerados como negativos. En algunos casos, la especie invasora tiene efectos positivos en sectores comerciales como la acuicultura (FAO DIAS 1998), en pesquerías (aumentando los stocks) y en la pesca recreativa (Minchin and Rosenthal 2002).

Algunos casos de especies introducidas que han adquirido importancia comercial a nivel local para consumo humano son el gasterópodo *Strombus persicus* y el cangrejo azul *Callinectes sapidus* (Mienis 1999).

El número de especies invasoras conocidas en el medio marino está relacionado con los recursos materiales y humanos empleados en el estudio del medio ambiente. Las áreas geográficas con una mayor o menor incidencia de especies invasoras y los grupos zoológicos más invasores dependen del número de estudios realizados en cada zona geográfica y el número de expertos taxónomos en la región. Un caso claro es la costa norte de África donde la citación de especies invasoras es claramente inferior a la costa Europea de Mediterráneo (Boudouresque and Verlaque 2002; Zenetos et al. 2003).

1.2.2 Especies invasoras en el mar Mediterráneo y Baleares

La posible pérdida de biodiversidad del Mediterráneo asociada a la presencia de especies introducidas es una disciplina de la ecología marina en continuo estudio. A día de hoy la introducción de especies no ha supuesto la extinción de especies nativas (Boudouresque 2004); sin embargo, aunque no se extingan, las especies mediterráneas se ven desplazadas por las invasoras, las cuales pueden ser favorecidas en algunos casos por la acción del hombre (provocando la alteración del hábitat y calentamiento global) (Galil 2007).

Los vectores de introducción de especies en el Mediterráneo son muy diversos, destacándose por su importancia:

- Apertura de Canal de Suez; es el principal vector de entrada de especies en la cuenca Mediterránea. Tras su construcción en 1869, se unieron dos regiones biogeográficas: la Atlántico-Mediterránea con la Indo-Pacífica permitiendo la dispersión de especies desde la región Indo-Pacífica al Mediterráneo Oriental, y con el paso del tiempo y el calentamiento del Mediterráneo, hasta el Mediterráneo Occidental.
- El transporte marítimo (aguas de lastre y *biofouling*), es el segundo vector de entrada de especies invasoras en el Mediterráneo. El mar Mediterráneo presenta un elevado tráfico marítimo comercial, que se ha incrementado probablemente desde la apertura del canal de Suez.

- La acuicultura es el tercer vector en importancia en el mar Mediterráneo. El cultivo de una especie fuera de su región de distribución original, sin las oportunas medidas de control, puede permitir que el organismo cultivado escape al medio y establezca poblaciones naturales por sus propios medios (Verlaque 2001).
- Las vía de comunicación natural, Estrecho de Gibraltar, permite que la entrada de especies Atlánticas en la cuenca Mediterránea.
- La introducción de especies es una realidad en la que un 10 % del total de especies introducidas no se sabe con certeza su vector (Fig 1).

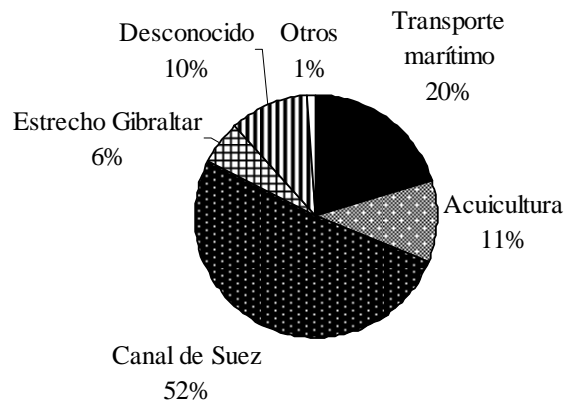

Fig. 1: Vectores de entrada de especies invasoras en el mar Mediterráneo (extraído de: Streftaris *et al.* 2005).

En Baleares las especies invasoras con carácter invasor más importante detectadas son el decápodo *Percnon gibbessi* (H. Milne Edwards) y las macroalgas *Lophocladia lallemandii* (Montagne), *Womersleyella setacea* (Hollenberg), *Acrothamnion preisii* (Sonder), *Asparagopsis taxiformis* (Delile), *Caulerpa racemosa* var *cylindracea* (Forsskal) y *Caulerpa taxifolia* (Vahl) C. Agardh.

Las macroalgas del género *Caulerpa* son plantas que desarrollan praderas sobre fondos arenosos y fangosos litorales, en ocasiones, ocupados previamente por angiospermas marinas. Las praderas de *Caulerpa* spp están formadas por clones que se inician a partir del asentamiento en el substrato de un cigoto o fragmento de talo, el

cual, desarrolla un cuerpo vegetativo que consta de un eje principal reptante fijado en el sustrato mediante rizoides del que surgen frondes fotosintéticos. Presentan una estructura sifonal, consecuencia de la cual cada clon de *Caulerpa* está formado por una única célula multinucleada que contiene entre una y varias vacuolas y una capa fina periférica de protoplasma. Las caulerpales presentan un rápido crecimiento, favorecido, por las altas temperaturas estivales (Terrados and Ros 1995).

Caulerpa taxifolia (Vahl) C. Agardh, alga de origen tropical, accidentalmente introducida en el mar Mediterráneo en 1984 desde el acuario de Mónaco (Jousson et al. 1998). Quince años después de su introducción, *C. taxifolia* se encuentra en las costas de Francia, Italia, Croacia, Túnez y España (Meinesz 2004). Esta alga se caracteriza por un rápido crecimiento, gran capacidad de formar praderas densas (más de 14.000 frondes/m²) y colonización de todo tipo de sustratos en la zona infralitoral.

Las concentraciones elevadas de nutrientes favorecen a *Caulerpa taxifolia*, situación en la que forma praderas monoespecíficas, pudiendo desplazar a la flora algal nativa (Verlaque and Fritayre 1994; Boudouresque et al. 1995), entrando en competencia por el sustrato con fanerógamas marinas como *Cymodocea nodosa* y *Posidonia oceanica* (Ceccherelli and Cinelli 1999a; Ceccherelli and Cinelli 1999b). *C. taxifolia* también afecta a la comunidad íctica, formando un entramado de frondes y estolones sobre el sustrato que impide el acceso al alimento de algunas especies de peces como *Mullus surmuletus* (Linnaeus) (Francour 1997; Levi and Francour 2004).

En las Baleares, *Caulerpa taxifolia* se encuentra sólo en la localidad de Cala d'Or (Mallorca), entre la pradera de *Posidonia oceanica*, zonas arenosas y sobre rizomas de *P. oceanica*. La primera cita de esta especie fue precisamente en Cala d'Or en el año 1992, a una profundidad de 6 metros (Pou et al. 1993). Desde el año 2003 hasta la actualidad, durante la recogida de muestras y trabajos de campo, se ha observado una reducción de las áreas con presencia de *C. taxifolia*. Este alga no forma praderas monoespecíficas y las áreas donde se ha detectado su presencia están rodeadas de *Posidonia oceanica* (Fig. 1) o de fondos arenosos (Fig. 2). En toda la zona no se encuentran grandes superficies cubiertas de esta caulerpal. Al tratarse de una especie de afinidad tropical, su biomasa se ve muy reducida durante el periodo invernal, donde la temperatura puede descender hasta los 13-14 °C.

Caulerpa racemosa var. *cylindracea* es un alga de origen australiano cuya presencia en el mar Mediterráneo data del año 1990. Desde esta fecha hasta la actualidad se ha extendido desde Chipre hasta España llegando a ser incluso citada en

las Islas Canarias (Verlaque et al. 2003; Verlaque et al. 2004). Morfológicamente se diferencia de *C. taxifolia* por tener unos frondes más cortos en forma de racimo de uvas. Su carácter invasor se ve reforzado por el rápido crecimiento que presenta, que le permite en menos de seis meses cubrir completamente el sustrato reduciendo la presencia de otras macroalgas (Piazzi and Cinelli 2001; Piazzi et al. 2003). Sus tasas de crecimiento máximas en Baleares pueden ser de 1 cm en 5 días (Jorge Terrados y Nuria Marbà com pers). El reemplazo de las comunidades de macroalgas nativas por *Caulerpa racemosa* var. *cylindracea* tiene efectos sobre los invertebrados bentónicos, provocando una proliferación de poliquetos, bivalvos y equinodermos y una reducción de gasterópodos y crustáceos (Argyrou et al. 1999).

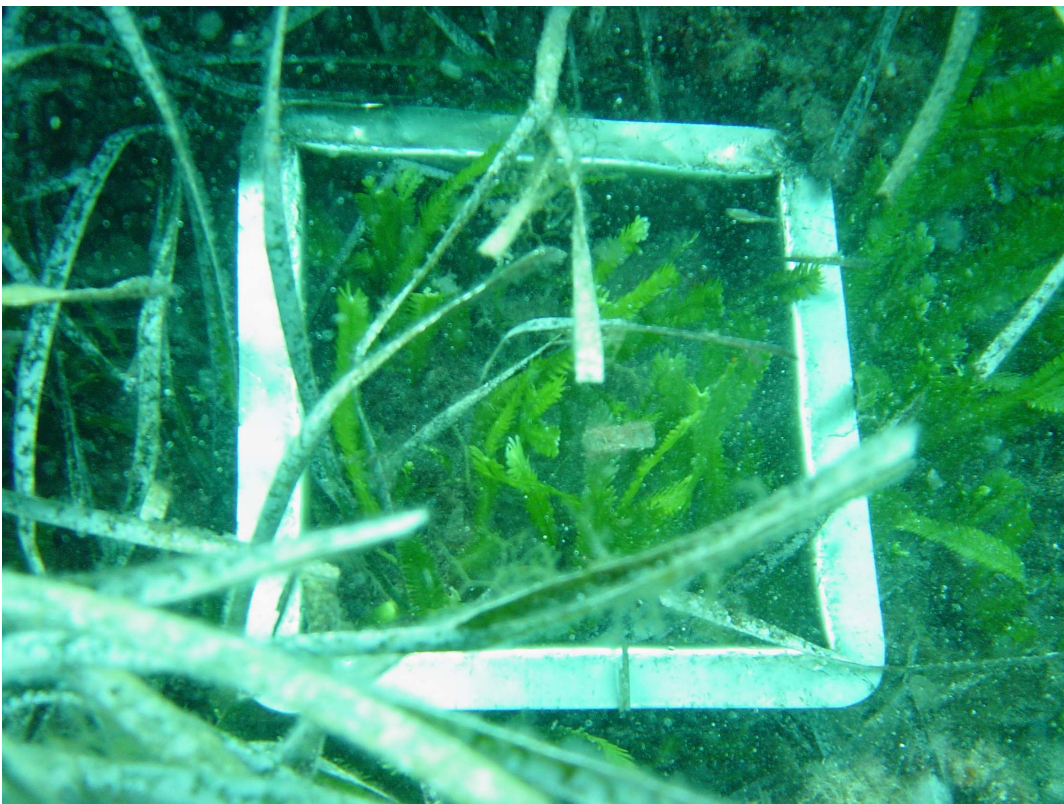

Fig 2: *Caulerpa taxifolia* creciendo entre la pradera de *Posidonia oceanica*. En la imagen se puede observar el cuadrante 20*20 cm utilizado para la recolección de muestras de fauna.



Fig 3: Zona de rizomas de *Posidonia oceanica* cubiertos por arena donde se observa la presencia del alga invasora *Caulerpa taxifolia*. En la imagen se observa que *C. taxifolia* no ocupa grandes superficies continuas.

Actualmente en las Islas Baleares, *C. racemosa* var *cylindracea* crece sobre todo tipo de sustratos de la zona infralitoral: rocoso, coralígeno, rizoma de *Posidonia oceanica* y fondos de arena (Ballesteros et al. 1999). Su presencia en Baleares data del año 1999, cuando fue identificada en la bahía de Palma (Ballesteros et al. 1999). En las zonas someras de Portals Vells, área de estudio (Mallorca) (4-8 metros), *C. racemosa* var *cylindracea* presenta un ciclo anual de biomasa muy marcado, con una cobertura total del sustrato durante finales de verano y otoño y pérdida casi completa de su biomasa visible durante el invierno dejando el sustrato sin cobertura vegetada (Fig 4, 5).

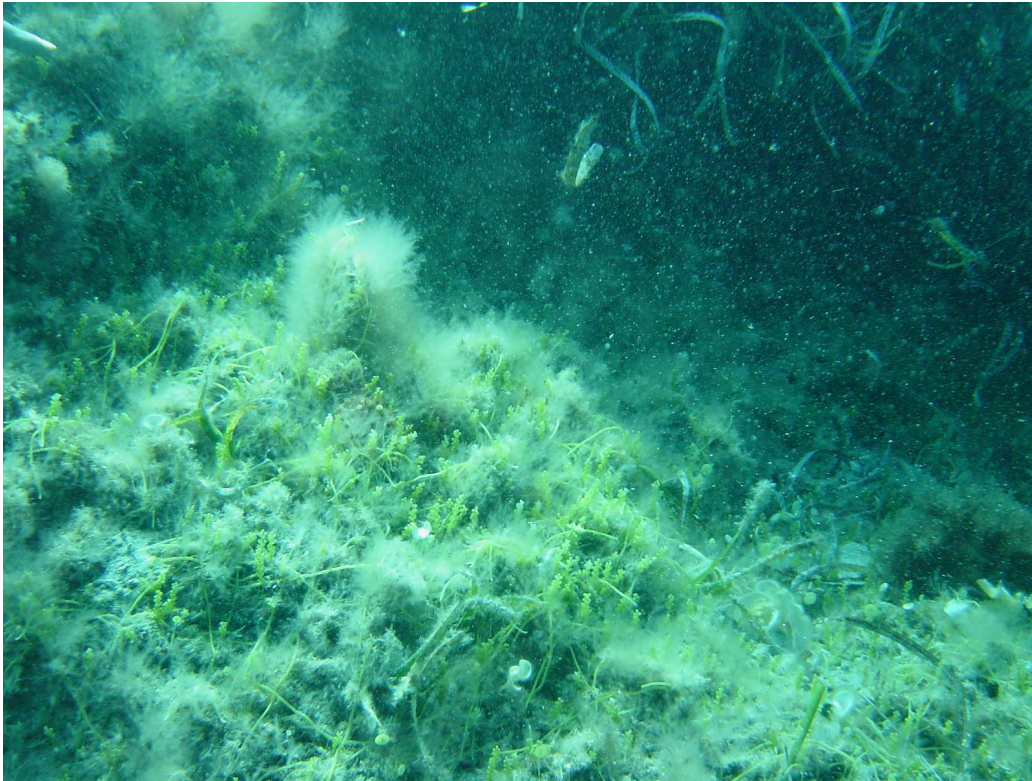

Fig 4: Zona de rizomas de *Posidonia oceanica* colonizados por *Caulerpa racemosa* var *cylindracea*. Al fondo de la imagen se puede observar la pradera de Posidonia.

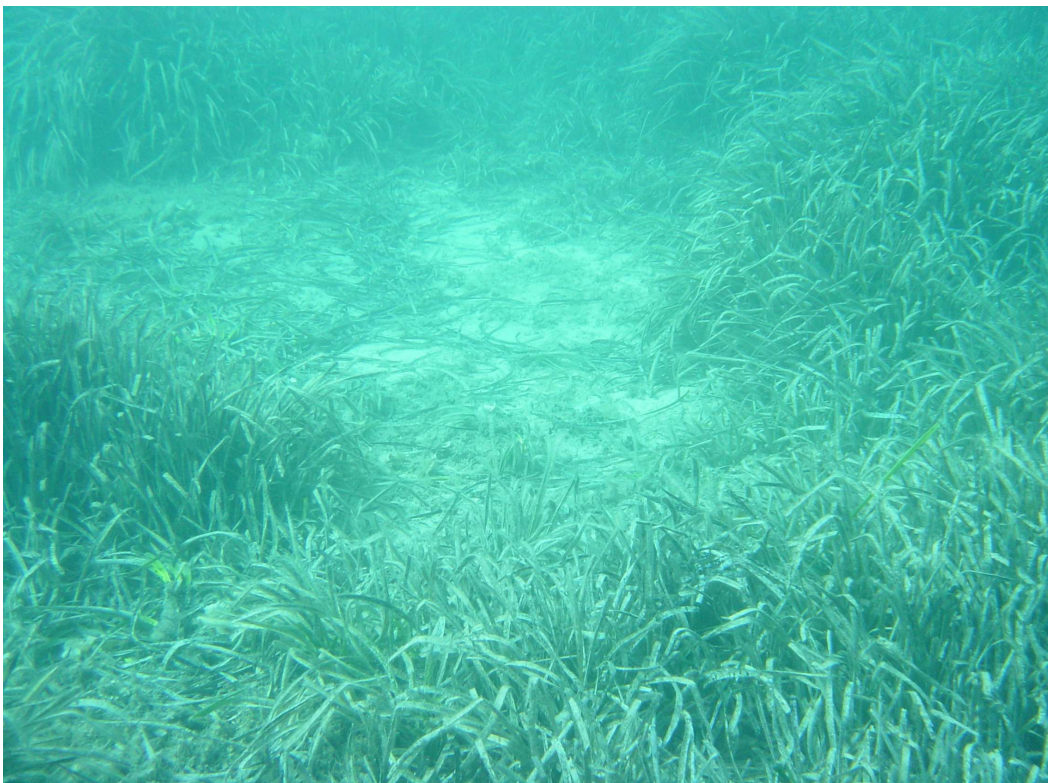

Fig 5: *Caulerpa racemosa* var *cylindracea* crece desde los bordes de la pradera de *Posidonia oceanica* hacia el interior de las zonas no vegetadas. Cubre totalmente el sustrato cuando alcanza su biomasa máxima.

1.3 Praderas de *Posidonia oceanica*, Caulerpales e Invertebrados

La *Posidonia oceanica* (L.) es una especie endémica de Mediterráneo ampliamente extendida por toda su cuenca en la que puede formar grandes praderas desde pocos metros de profundidad hasta 40 metros (Buia et al. 2000). Es considerada como un ecosistema prioritario por la Unión Europea en la Directiva Habitats (92/43/CEE). Las praderas de *P. oceanica* son equiparables en importancia a los bosques terrestres formados por una sola especie arbórea (Templado *et al*, 2004). Sobre sus hojas y rizomas crecen gran cantidad de macroalgas e invertebrados epífitos que forman una comunidad diversa en especies y compleja en estructura y funcionamiento. Su importancia no solamente radica en la gran diversidad de especies asociadas que alberga, sino que es además el principal productor primario bentónico y uno de los ecosistemas más extendidos en toda la cuenca mediterránea.

Las praderas de *Posidonia oceanica* son un hábitat muy complejo con dos estratos bien diferenciados: el estrato rizomático y el estrato foliar. El estrato foliar se caracteriza por ser efímero, produciéndose a lo largo del tiempo una renovación de las hojas. Estas se ven sometidas a un movimiento continuo debido a la acción del oleaje y al ramoneo de algunas especies como el pez *Sarpa salpa*, por lo que en muchos casos, fragmentos o hojas se pierden de los haces. Las especies que encontramos sobre o entre las hojas son todas especies típicas de un hábitat fotófilo (Fig 6) como el gasterópodo *Smaragdia viridis*, el decápodo *Hippolyte* spp y el pez *Symphodus* spp.

En el estrato rizomático de *Posidonia oceanica* nos encontramos con una comunidad más esciáfila. Se trata de un estrato más estable y puede presentar una gran complejidad debido al gran grosor que puede alcanzar (varios metros). Alberga mayor número de especies excavadoras y detritívoras, como los crustáceos *Alpheus dentipes*, *Athanas nitescens* o los poliquetos *Chone collaris*, *Amphiglena mediterranea*.

También es frecuente encontrar especies con migraciones nictamerales, que generalmente buscan refugio de día en el rizoma y ascienden al estrato foliar durante la noche, como son los anfípodos *Ampelisca* spp, *Dexamine spinosa* o los decápodos *Processa edulis*, *Calcinus tubularis* y *Cestopagurus timidus*.

La riqueza y diversidad de especies que encontramos en las praderas de *Posidonia oceanica*, considerando todos sus estratos, es tal que podemos hablar de más

de 123 especies de foraminíferos (Mateu-Vicens com. pers.), 20 de esponjas, 21 de cnidarios, 3 de platelmintos, 227 de anélidos poliquetos, 201 de moluscos, 139 de crustáceos, 27 de lofoforados, 26 de equinodermos, 24 de tunicados y 84 de osteíctios (Templado et al, 2004). Algunas de estas especies han evolucionado y desarrollado adaptaciones para camuflarse y alimentarse dentro de las praderas de fanerógamas como son algunos signátidos y los peces del género *Symphodus*, entre otros.

Las praderas de *Posidonia oceanica* sufren un proceso de regresión en el Mediterráneo debido a gran número de perturbaciones, generalmente asociadas a la actividad humana (Diaz-Almela et al. 2007). La muerte de *Posidonia* se traduce en una pérdida de la parte foliar. Los rizomas de *P. oceanica* son una estructura más persistente en el tiempo, muy rica en ligninas, que presenta unas tasas de ingesta de herbívoros prácticamente nula. Una vez desaparecida la parte folial de la pradera, la mata muerta es un sustrato sobre el que las caulerpales se asientan preferencialmente (Gamundí et al, 2006). Este tipo de hábitat está muy extendido a lo largo del litoral Balear y lo podemos encontrar en grandes extensiones en zonas como la Bahía de Palma o la zona de Puerto Adriano.

Los efectos de *Caulerpa* sobre otras macroalgas han sido estudiados, encontrándose una reducción de la diversidad (Balata et al. 2004; Piazzzi and Ceccherelli 2006). Los trabajos sobre comunidades de invertebrados en *C. taxifolia* en la actualidad son escasos y tratan principalmente de los cambios en comunidades faunísticas (BellanSantini et al. 1996; Travizi and Zavodnik 2004), adaptación de opistobranquios y uso de los metabolitos secundarios de *Caulerpa* como mecanismos de defensa por parte de los invertebrados (Guerriero et al. 1995; Thibaut and Meinesz 2000; Gianguzza et al. 2002; Cutignano et al. 2004; Trowbridge 2004; Cavas et al. 2005b), efectos nocivos de la caulerpenina sobre los huevos de erizo y su escasa importancia en la dieta de *Paracentrotus lividus* (Boudouresque et al. 1996; Lemee et al. 1996; Pedrotti et al. 1996; Ganteaume et al. 1998; Pesando et al. 1998; Pedrotti and Lemee 1999; Girard et al. 2000; Erickson et al. 2006). Los efectos de *C. taxifolia* sobre las especies ícticas ha sido más estudiado pudiéndose destacar los trabajos sobre el cambio en el comportamiento del pez *Mullus surmuletus* (Levi and Francour 2004; Longepierre et al. 2005), cambios en la coloración de lábridos (Levi et al. 2005) y modificaciones en la composición de especies que habitan las zonas invadidas (Relini et al. 1998; Uchimura et al. 1999b; Relini et al. 2000; York et al. 2006).

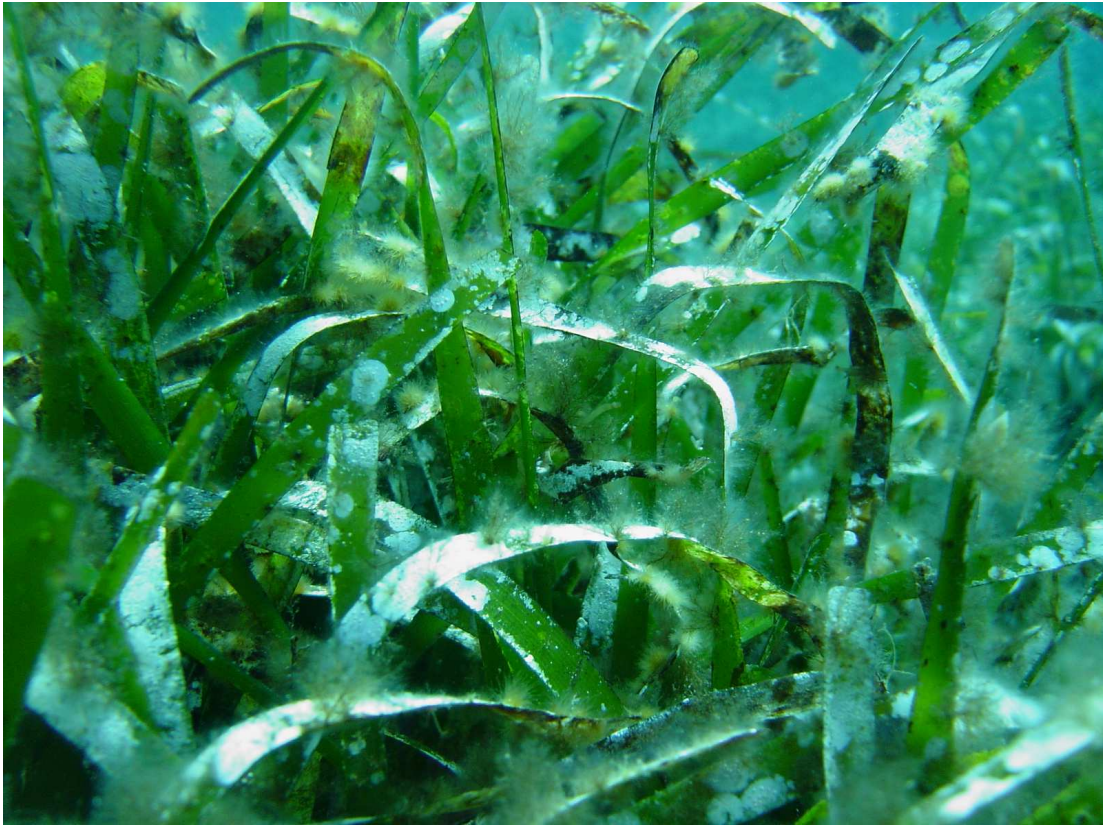

Fig 6: Detalle de pradera de *Posidonia oceanica*. En la imagen puede apreciarse la gran cantidad de epifitos que pueden presentar las hojas de *P. oceanica*.

En *Caulerpa racemosa* dos trabajos científicos tratan sus efectos sobre las comunidades de invertebrados. El primero, desarrollado en Chipre, concluye que la presencia de *Caulerpa* afecta negativamente a los moluscos y los poliquetos aumentan sus abundancias y diversidad (Argyrou et al. 1999). Otro más reciente, realizado en la costa de Italia, concluye que tiene un efecto positivo sobre las comunidades de moluscos, especialmente para sus formas juveniles (Buia et al. 2001). Ambos trabajos son muestreos puntuales por lo tanto es difícil de interpretar a que nivel se producen cambios en las comunidades de invertebrados tras la sustitución de *Posidonia oceanica* por algas invasoras del género *Caulerpa*.

Para evidenciar el cambio que produce la caulerpal invasora sobre el bentos se ha considerado una tercera especie de caulerpal, *Caulerpa prolifera*, considerada como establecida en el Mediterráneo (Fig. 7, 8). Al tratarse de una especie común de aguas Mediterráneas y Atlánticas, hay gran cantidad de literatura que trata sobre sus comunidades de invertebrados y sus variaciones estacionales (Thibaut and Meinesz 2000; Sanchez-Moyano et al. 2001a; Sanchez-Moyano et al. 2001b; Guerra-Garcia et al. 2002; Sanchez-Moyano et al. 2004; de la Rosa et al. 2006). Su comunidad de

invertebrados es típica de fondos blandos o arenosos, con los que comparte gran número de especies, pero también aparecen especies especializadas en el consumo directo de *C. prolifera*, como son los opistobranquios *Ascobulla fragilis*, *Oxynoe olivacea* y *Lobiger serradifalci*. Es por ello que la comunidad de *C. prolifera* presenta una comunidad de invertebrados asociada característica, con especies muy especializadas a vivir exclusivamente en zonas con disponibilidad de *Caulerpa*.



Fig 7 Zona de rizomas de *Posidonia oceanica* colonizados por *Caulerpa prolifera*.



Fig 8 Zona de *Caulerpa prolifera*. En la imagen se puede ver como la pradera de *Posidonia oceanica* en la bahía de Cala d'Or está muy deteriorada y *C. prolifera* ocupa casi todo el sustrato en la zona de muestreos.

1.4 Caulerpenina y Biomarcadores de estrés oxidativo

1.4.1 Metabolitos secundarios, Caulerpenina

Las caulerpales se caracterizan por contener sustancias tóxicas para los herbívoros con la finalidad de evitar ser consumidas (Erickson et al. 2006). Las defensas de las algas verdes (Chlorophyta) son especialmente disuasorias para los herbívoros mediante la producción de metabolitos secundarios repulsivos y tóxicos para los consumidores potenciales (Doty 1966; Maiti et al. 1978; Mahendran et al. 1979; Nielsen et al. 1982; Schwede et al. 1987; Jung et al. 2002). Entre estas sustancias podemos encontrar polifenoles, terpenos, bases aminoácidas y compuestos halogenados, que se caracterizan, por afectar a la palatabilidad del alga. Dentro de los metabolitos secundarios producidos por las caulerpales, se debe destacar la caulerpenina como principal sustancia activa inhibidora, tanto del herbivorismo como del epifitismo (Pohnert and Jung 2003). Esta sustancia afecta negativamente al crecimiento de microorganismos, al desarrollo de los huevos fecundados de *Paracentrotus lividus* y posee efectos citotóxicos sobre las células humanas (ParentMassin et al. 1996; Pesando et al. 1996; Barbier et al. 2001). La toxicidad de la caulerpenina se incrementa cuando el alga es dañada, ya que se transforma en oxitoxinas más tóxicas y repelentes (Gavagnin et al. 1994; Jung and Pohnert 2001). A pesar de su toxicidad, algunas especies de peces tropicales macroherbívoros ingieren sin problema aparente *Caulerpa* (Meyer y Paul, 1992).

1.4.2 Estrés oxidativo

La toxicidad del oxígeno se explica por la producción de los denominados radicales libres del oxígeno, altamente reactivos y responsables de la lesión e incluso de la muerte celular en circunstancias patológicas. Además de las especies reactivas de oxígeno (reactive oxygen species, ROS), hay muchas otras moléculas que pueden ser origen de especies reactivas, como las derivadas del nitrógeno (tabla 1).

Tabla 1. Principales especies activas del oxígeno y de los nitrógenos relacionados con el estrés oxidativo

Radicales		No radicales	
$O_2^{\cdot-}$	Anión superóxido	H_2O_2	Peróxido de hidrógeno
OH^{\cdot}	Radical hidroxilo	1O_2	Oxígeno singlete
HO_2^{\cdot}	Radical hidroxiperoxilo	$HOCl$	Hipoclorito
ROO^{\cdot}	Radical peroxilo	$ONOO^{\cdot}$	Peroxinitrito
RO^{\cdot}	Radical alcoxilo		
NO^{\cdot}	Óxido nítrico		

Estas ROS son altamente reactivas y pueden afectar a las propias estructuras celulares alterando su función (Halliwell 1994). Para contrarrestar estos radicales libres las células disponen de un complejo sistema antioxidante que les permite mantener un balance equilibrado y limitar el daño celular (Clarkson and Thompson 2000). Debido a que las ROS se generan de forma continuada, es esencial una continua regeneración de las defensas antioxidantes para mantener la homeostasis celular (Packer 1997). La situación de estrés oxidativo aparece como consecuencia de un desequilibrio entre la producción de especies reactivas y las defensas antioxidantes del organismo (Todorova et al. 2004).

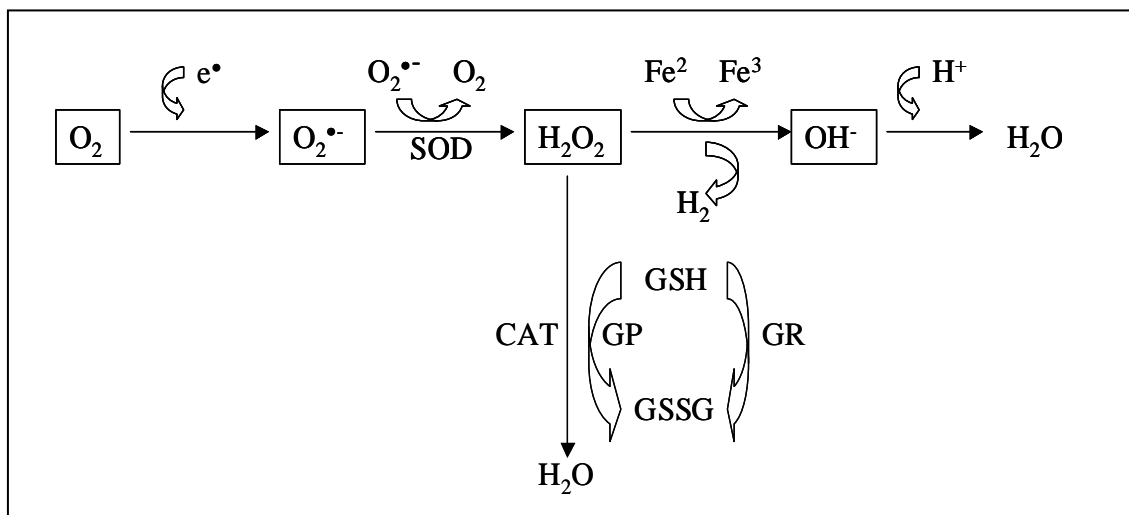

Fig 6: Principales especies reactivas de oxígeno y enzimas antioxidantes

En los seres vivos, en condiciones normales, las células metabolizan la mayor parte del oxígeno, incluso el agua sin la formación de intermediarios tóxicos. Sin embargo una parte de este oxígeno genera ROS mediante la adición sucesiva de electrones al oxígeno molecular (Livingstone 2001). Ha sido estimado que aproximadamente entre el 1-3% del O_2 consumido por los animales se transforma en

ROS. Los sistemas biológicos han desarrollado a lo largo de su evolución mecanismos enzimáticos y no enzimáticos para proteger sus componentes celulares del daño oxidativo.

El balance entre la generación y la neutralización de ROS por los mecanismos antioxidantes en el organismo, es lo que se conoce como estrés oxidativo (Davies 1995). En organismos acuáticos y terrestres el estrés oxidativo se ha convertido en un importante objetivo de estudios (Ames et al. 1993; Livingstone 2001).

Los seres vivos disponen de un complejo sistema antioxidante que incluye compuestos y enzimas antioxidantes de vital importancia para eliminar las ROS y reducir el daño celular (Clarkson and Thompson 2000). El sistema antioxidante está formado por antioxidantes endógenos que pueden ser enzimáticos, no enzimáticos y antioxidantes exógenos. Los seres vivos generan ROS de forma continua, por lo es necesaria la permanente regeneración de los enzimas antioxidantes para mantener la homeostasis. Estos antioxidantes actúan reduciendo las ROS, tanto en espacios intracelulares como extracelulares.

Los antioxidantes actúan de diferentes maneras reduciendo las ROS:

- Reduciendo las concentraciones locales de oxígeno libre.
- Quelando iones metálicos o inactivando sustancias prooxidantes.
- Eliminando las especies reactivas de oxígeno o transformándolas en sustancias menos activas.
- Previniendo la formación de radicales libres o evitando la transformación de las formas más reactivas en formas más activas.
- Reparando el daño oxidativo e incrementando la eliminación de moléculas dañadas.

Los enzimas antioxidantes son los principales responsables de la transformación de las ROS en especies no reactivas y la reparación de los posibles daños de la oxidación. Los enzimas antioxidantes primarios encargados de eliminar un tipo concreto de ROS incluyen la superóxido dismutasa (SOD), glutatión peroxidasa (GPX) y la catalasa (CAT). Es también muy importante la participación de la glutatión reductasa (GR) que es la responsable de regenerar la glutatión para que pueda actuar la GPX.

SOD

Este enzima es el responsable de la detoxificación del anión superóxido. El enzima dismuta los radicales superóxido para generar peróxido de hidrógeno y oxígeno molecular.

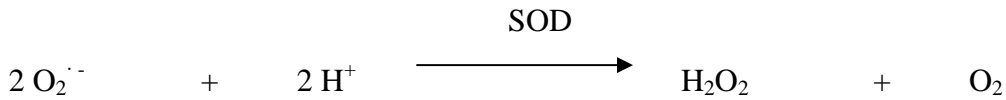

GPX

Es la responsable de la canalización de la reducción del peróxido de hidrógeno en agua y de hidroperóxidos orgánicos a alcohol usando el glutatión reducido (GSH) como dador de electrones (Halliwell et al. 1989).

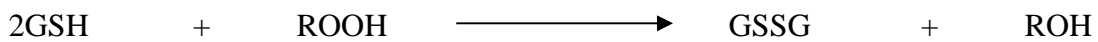
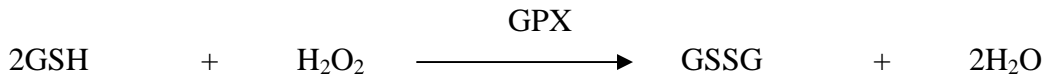

La reacción realizada mediante el enzima glutatión peroxidasa usa como sustrato glutatión reducido (GSH) y se forma glutatión oxidado (GSSG). Para que los mecanismos de detoxificación de ROS sigan funcionando es necesario reciclar el GSSG y volver a tener GSH para que la GPX pueda seguir eliminando H₂O₂ y ROOH. El enzima encargado de transformar el GSSG en GSH es la glutatión reductasa que cataliza la siguiente reacción:

GR

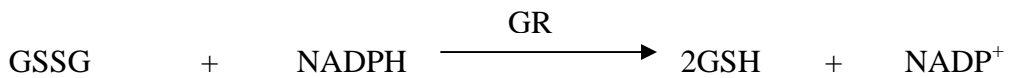

CATALASA

Es el enzima encargado de catalizar la descomposición del peróxido de hidrógeno en agua y oxígeno molecular, de una manera independiente a la glutatión.

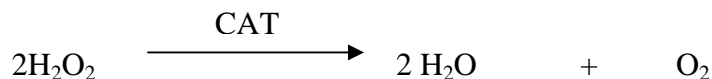

Los antecedentes sobre la aplicación de biomarcadores muestran que la presencia de ROS puede ser incrementada por la presencia de un amplio número de compuestos naturales o producidos por el hombre. Posibles fuentes antropogénicas de

compuestos que incrementan el ROS y la producción de otros radicales libres pro-oxidantes incluyen compuestos orgánicos, como los PAHs (benceno, productos de oxidación de PAH) hidrocarburos halogenados (bromobenceno, PCBs, lindano) dioxinas y pentaclorofenol, metales (Al, Ar, Cd, Cr, Hg, Ni, Va) gases (NO₂, O₃, SO₂), peróxidos, radiación ultravioleta, hipoxia e hiperoxia (Livingstone 1991; Livingstone 2001). En la bibliografía podemos encontrar gran número de trabajos referentes a la variación de las defensas antioxidantes y la presencia de contaminantes de origen antropogénico (Winston and Digiulio 1991; Livingstone et al. 1992; Livingstone et al. 1995; Solé et al. 1996; Bard 2000; Regoli 2000; Martínez-Álvarez et al. 2005; Valavanidis et al. 2006).

A pesar de que gran parte de los estudios relacionados con el ROS están efectuados en relación a los compuestos producidos por el hombre, existen una serie de estudios que analizan los efectos de compuestos naturales sobre los organismos marinos. Un ejemplo es que la producción de microcistinas por cianobacterias induce estrés oxidativo en el pez *Oreochromis* sp (Jos et al. 2005). Además de lo anteriormente explicado, las actividades antioxidantes están también influidas por factores intrínsecos de la especie como son la edad del pez, sus hábitos alimenticios y factores ambientales (Martínez-Álvarez et al. 2005).

Capítulo 2

CAMBIOS EN LAS COMUNIDADES DE MOLUSCOS CHANGES IN MOLLUSCAN COMMUNITIES

Capítulo adaptado de:

A mollusc community associated with the invasive *Caulerpa racemosa* in the Western Mediterranean shallow seagrass beds. In prep. Authors Box, A., Deudero, S., and Pons, G. X.

How different is the mollusc community between invasive *Caulerpa taxifolia* (Chlorophyta: Caulerpaceae) and established *C. prolifera* in shallow seagrass beds of the Western Mediterranean. In prep. Authors Box, A., Deudero, S. and Pons, G. X.

2.1 Introducción al capítulo.

En el presente capítulo se analizan los resultados obtenidos referentes a la abundancia y la diversidad de la fauna de moluscos presentes en *Caulerpa racemosa* var. *cylindracea*, *C. taxifolia*, *C. prolifera* y la fanerógama marina *Posidonia oceanica*.

Los moluscos son un filum dividido en ocho clases, dentro de las cuales, destacan los bivalvos y gasterópodos por su abundancia y diversidad de especies en zonas litorales y praderas de *Posidonia oceanica*. Dentro de los gasterópodos, encontramos especies especializadas en el consumo directo de *Caulerpa*, como son *Oxynoe olivacea*, *Lobiger serradifalci* y *Ascobulla fragilis* (Thibaut and Meinesz 2000; Gianguzza et al. 2002; Cutignano et al. 2004; Trowbridge 2004; Cavas et al. 2005b). También hay organismos mesoherbívoros, como *Bittium reticulatum*, *Rissoa* spp. y *Alvania cimex*, que son capaces de incluir en su dieta todo tipo de macroalgas y, en algunos casos, también *Caulerpa*. La clase de los bivalvos presenta un elevado número de especies filtradoras que se ven negativamente afectadas por las elevadas biomásas de *Caulerpa prolifera* (Sánchez-Moyano et al. 2001b).

En el primer trabajo “A mollusc community associated with the invasive *Caulerpa racemosa* var. *cylindracea* in the Western Mediterranean” se compara la abundancia, diversidad de especies y estacionalidad de moluscos entre *Caulerpa racemosa* var. *cylindracea* y *Posidonia oceanica*. Para ellos se recogieron muestras bimensualmente, de diciembre 2003 a febrero de 2005 mediante un cuadrante 20 x 20 cm insertado 5 cm de profundidad en el sedimento.

En las muestras recogidas se han identificado y cuantificado las especies de moluscos halladas. Simultáneamente se han separado las diferentes fracciones de *Posidonia oceanica* (raíces, vainas, hojas vivas, hojas muertas) además de la biomasa de *Caulerpa racemosa* var. *cylindracea* cuando ésta estaba presente. Con la misma periodicidad que las muestras de bentos, se recogieron tres *cores* de 3.5 cm de diámetro con el objetivo de estimar la granulometría. Estos parámetros estructurales del hábitat han sido considerados como variables que pueden afectar a los descriptores de la comunidad de moluscos.

El segundo estudio “How different is the mollusc community between invasive *Caulerpa taxifolia* (Chlorophyta:Caulerpaeae) and established *C. prolifera* in shallow seagrass beds of the Western Mediterranean?” se analiza la malacofauna a nivel de

especies, abundancias y estacionalidad entre *Caulerpa prolifera* y *Caulerpa taxifolia*. Este trabajo se ha realizado a lo largo de los años 2003-2004 mediante la recogida de muestras con una periodicidad bimensual, con un cuadrante 20 x 20 cm insertado 5 cm en el sedimento. De las muestras recogidas se han apartado los moluscos encontrados además de separarse las fracciones de *Posidonia oceanica* y la biomasa de *Caulerpa* spp. Con la misma periodicidad se recogieron tres *cores* de diámetro 3.5 cm para estimar la granulometría de las áreas estudiadas.

Para comprender el efecto de la biomasa de caulerpales sobre la fauna de moluscos, se han realizado análisis estadísticos con las finalidades de estimar la importancia de la biomasa de *Caulerpa* sobre algunas especies de moluscos y descriptores de la comunidad (abundancias, número de especies, diversidad). En los trabajos presentados en este capítulo, al completarse uno o dos ciclos anuales de biomasa de *Caulerpa*, pueden estudiarse tanto el impacto de la biomasa de *Caulerpa* sobre los moluscos de manera temporal como a nivel de diferenciación respecto a la pradera de *Posidonia oceanica*.

Para la correcta identificación de las especies se han utilizado como obras de referencia los trabajos taxonómicos “Atlante delle conchiglie marine del Mediterraneo” Vol I, II y III (Giannuzi-Savelli et al. 1994; Giannuzi-Savelli et al. 1996; Giannuzi-Savelli et al. 1999), “European SeaShells” (Poppe and Goto 1991; Poppe and Goto 1993) y las publicaciones de (Nordsieck 1969; Nordsieck 1972; Nordsieck 1982). Además, la clasificación aquí propuesta se ha comparado con las publicaciones científicas disponibles. La correcta nomenclatura de las especies ha sido verificada mediante el “CLEMAM, Check List of European Marine Mollusca”, <http://www.somali.asso.fr/clemam/index.clemam.html> y “ERMS, The European Register of Marine Species”, <http://www.marbef.org/data/erms.php>.

2.2 A mollusc community associated with invasive *Caulerpa racemosa* in the Western Mediterranean shallow seagrass beds.

Abstract

This study focuses on the mollusc community in an area where *Caulerpa racemosa* var. *cylindracea* has invaded a *Posidonia oceanica* seagrass meadow. There were significant differences between *C. racemosa* var. *cylindracea* and *P. oceanica* in the contribution of structural components of *P. oceanica* and the mean grain size between the two meadows. A total of 1,925 individual molluscs comprising 37 species were collected in the *C. racemosa* var. *cylindracea* mats. Twenty bivalve species and thirty-seven gastropod species were identified in *Caulerpa* mats. The dominant species of gastropods were *Bittium reticulatum*, *Alvania cimex*, *Ascobulla fragilis*, *Nassarius incrassatus*, *Smaragdia viridis*, *Rissoina bruguieri*, *Cerithium vulgatum* and *Gibbula ardens* and for bivalves *Glans trapezia*, *Ctena decussata*, *Loripes lacteus*, *Limaria hians*, *Venerupis aurea*, *Venus verrucosa* and *Musculus costulatus* were the most abundant. The highest number of mollusc species (6.75 ± 3.59) in *C. racemosa* var. *cylindracea* was determined according to its maximum biomass. Most of the molluscan species found in *C. racemosa* var. *cylindracea* were typical of those found in seagrass beds and among photophilous macroalgae. The main differences between the molluscs found in *C. racemosa* var. *cylindracea* vs. in *P. oceanica* were due to different numbers of coincident species such as *Glans trapezia*, *Ctena decussata*, *Alvania cimex* and *Rissoina bruguieri* in *C. racemosa* var. *cylindracea*. Moreover, *Arca noae* and *Striarca lactea* had greater abundances on *P. oceanica* than *C. racemosa* var. *cylindracea*. *Caulerpa racemosa* var. *cylindracea* does not affect negatively the mollusc abundances and diversity. Only one specialised feeder (*Ascobulla fragilis*) of *Caulerpa* was found.

Key words: benthos; *Caulerpa racemosa* var. *cylindracea*; introduced species; Marine mollusc; Mediterranean Sea; seaweed.

Introduction

The introduction of species is recognised as a major driver of change in marine environments and contributes to the loss of biodiversity in ecosystems (Sakai et al. 2001). The growth of international shipping, aquaculture and aquarium trade has promoted the introduction of species in marine ecosystems (Boudouresque and Verlaque 2002) and consequently has increased the frequency of invasion events. The main effect of invasive species is a reduction in biodiversity and an alteration of the structure and functioning of the invaded ecosystems (Mack et al. 2000; Boudouresque and Verlaque 2002; MacDougall and Turkington 2005).

The presence of alien species in the Mediterranean Sea is an increasing problem, with approximately 662 introduced species (Gollasch 2006). Currently, 84 introduced macrophytes are reported to be in the Mediterranean Sea (Boudouresque and Verlaque 2002). Two of these alien algal species belong to the green algae genus *Caulerpa*: *C. taxifolia* and *C. racemosa*. Their presence induces changes in faunal composition and abundance in the affected systems, and they are thus becoming a serious problem in the Western Mediterranean (Pandolfo and Chemello 1995; BellanSantini et al. 1996; Argyrou et al. 1999; Buia et al. 2001). The genus *Caulerpa* produces anti-herbivorous secondary metabolites (Amade and Lemee 1998; Jung et al. 2002), with caulerpenyne being the major one of these; this affects grazers negatively (Boudouresque et al. 1996; ParentMassin et al. 1996; Pesando et al. 1996; Amade and Lemee 1998; Pesando et al. 1998; Sureda et al. 2006). It also changes the chemical environmental conditions of the habitat (Amade and Lemee 1998; Sureda et al. 2006).

This study focuses on the macroalgae *Caulerpa racemosa* var. *cylindracea*. In the Mediterranean basin *C. racemosa* var. *cylindracea* has been reported in 11 countries: Albania, Croatia, France, Greece, Israel, Italy, Libya, Malta, Spain, Tunisia and Turkey (Verlaque et al. 2003) and has now reached the Canary Islands (Verlaque et al. 2004). *Caulerpa racemosa* var. *cylindracea* spreads in sheltered and exposed areas, colonising all types of substrates in water depths of up to 70 m (Argyrou et al. 1999; Piazzini and Cinelli 1999; Zuljevic et al. 2003). On Mallorca Island, the first record of *C. racemosa* var. *cylindracea* was reported in 1999 in Palma Bay (Ballesteros et al. 1999) and it is now common elsewhere around the island (with the exception of the north coast).

Posidonia oceanica (L.) Delile seagrass meadows constitute one of the most important Mediterranean ecosystems with an estimated coverage of between 2.5 and 5.5 million hectares (Buia et al. 2000). Seagrass beds are characterised by a leafy canopy and root-rhizome layer that significantly influences the fauna associated with it (Buia et al. 2000; Borg et al. 2006). Even dead (i.e., after losing the foliar structures) *Posidonia* beds still support a rich macrofauna in terms of the number of species and diversity (Borg et al. 2006). Previous work has shown that the colonization of the substrate by *C. racemosa* changes the mollusc communities, but there is no clear trend in the magnitude of this change. Argyrou et al. (1999) found a decrease in the abundance of molluscs in Cyprus while Buia et al. (2001) detected an increase in mollusc densities at the Gulf of Salerno; both of these changes were induced by the colonisation of *Caulerpa racemosa*.

The aim of this work was to study the mollusc community associated with the presence of invasive *Caulerpa racemosa* var. *cylindracea*. In addition, the seasonal changes in the mollusc community were studied with special effort in order to clarify the effect of *C. racemosa* var. *cylindracea* biomass according its seasonality. This study was completed with a simultaneous study of the seagrass *Posidonia oceanica* to compare the changes in the mollusc community associated with the presence of *C. racemosa* var. *cylindracea*.

Materials and methods

Study area and sampling design

The study was carried out on Mallorca Island (Balearic Islands, Western Mediterranean). Two sites, which had similar bathymetry (5-8 m depth) and similar hydrodynamic regimes (enclosed bays), were selected. *Caulerpa racemosa* var. *cylindracea* was collected in Portals Vells Bay, Southwest Mallorca (N 39° 28.321' / E 2° 31.320'). *Caulerpa racemosa* var. *cylindracea* does not form mono-specific mats in this area and grows over *P. oceanica* rhizome patches on sandy bottoms and on the living seagrass. To compare mollusc communities, a living *Posidonia oceanica* seagrass bed was chosen. This meadow was located in a non-*Caulerpa* invaded area in Cala D'Or Bay, Southeast Mallorca (N 39° 22.164' / E 3° 13.887' and N 39° 22.028').

Six replicate samples per meadow on each sampling date were collected bimonthly during the period from December 2003 until December 2004. One additional sampling date occurred in February 2005 to sample “zero” biomass (no visible presence) for *C. racemosa* var *cylindracea* and *P. oceanica*. Each sample was collected using a 20 x 20 cm frame inserted 5 cm into the sediment, providing a total sampling volume of 2,000 cm³ or a surface area of 400 cm². The frames were sampled by SCUBA during morning hours (11-12 h GTM). Samples were placed in a 500-µm plastic mesh bag until being processed at the laboratory.

Simultaneously to faunal samples collection, three cores (3.5 cm diameter) per meadow and sampling date were inserted 5 cm into the sediment at each location to characterise grain size. To characterise the sampling zone visually, a digital analysis of aerial photographs of the sampling area was performed using SIGPAC software version 4.0. This method estimated *Posidonia oceanica* living meadows and sandy bottoms or dead *Posidonia* mats, as well as calculating the amount of substrate totally colonised during maximum *C. racemosa* var. *cylindracea* biomass.

Seawater temperature was recorded using StowAway[®] Tidbit[®] (Onset Computer Corporation, Pocasset, MA, USA) temperature loggers installed permanently at the sampling depth in both bays.

Sample processing

Individual molluscs were sorted from samples in the laboratory using a stereomicroscope. After sorting, organisms were kept in 70% ethanol and identified to the lowest taxonomic level possible. Identification was not possible for some juvenile bivalve species and one opisthobranch species.

Posidonia oceanica rhizomes, roots, sheaths and leaves were dried for 24 h at 60°C to estimate the percentage contribution to the sample of aboveground (leaves and flowers) and belowground (roots, rhizomes and sheaths) structures. *Caulerpa racemosa* var *cylindracea* biomass was also dried for 24 h at 60° C to estimate the dry weight of the algae in the sample. *Caulerpa racemosa* var. *cylindracea* biomass and *Posidonia oceanica* structural biomass were also characterized in the samples.

Mean grain size fractions were estimated following the Wentworth scale after eliminating organic matter from samples using H₂O₂ and drying the sample for 24 h.

Statistical analysis

For community structural parameters, *Posidonia oceanica* components and grain size fraction differences between the living *P. oceanica* meadow and invasive *C. racemosa* var. *cylindracea* area were tested using two-way ANOVA (factors were meadow (2 levels) and time (6 levels)). Differences in the number of mollusc species and abundances between meadows were tested by two-way ANOVA (factors were meadow (2 levels) and time(6 levels)). Analyses were carried out using the SPSS v. 15.0 package.

To analyse differences in mollusc species composition between *C. racemosa* var. *cylindracea* and a similar area in the *P. oceanica* seagrass meadow, multivariate analyses were carried out. Species abundance data (pooled by meadow and date and 4th-root transformed to minimise the contribution of dominant species) was analysed using PRIMER v. 5.0. A ranked triangular matrix was constructed using the Bray-Curtis similarity algorithm. A representation of the results was obtained with a Cluster similarity dendrogram. Differences between *C. racemosa* var. *cylindracea* and *P. oceanica* were tested using ANOSIM (PRIMER 5.0). The SIMPER procedure (PRIMER 5.0) was applied to analyse the mollusc species with the highest contribution to the dissimilarity between meadows.

Dominance (D) (relative abundance of a particular species within the sample) was calculated for each bimonthly sample and for the total of all samples collected. The frequency index was calculated as the percentage of bimonthly samples in which a particular species was present over the sampling period. The following basic and derived parameters were also calculated for each sample: number of individuals in the sample, number of species and Shannon diversity index (H') (Krebs, 1989). The evenness index (J) (Pielou, 1969) was also calculated using the DIVERSE routine (PRIMER v. 5.0). Pearson correlations using SPSS vs. 15.0 examined relationships between mollusc characteristics with temperature and *Caulerpa* biomass.

Results***Caulerpa* and *Posidonia* structural factors**

Statistical analyses indicated that the percentage contribution of the *Posidonia oceanica* root-rhizome fraction (higher in *C. racemosa* samples) and the canopy of

Posidonia oceanica (higher in *P. oceanica* samples) were significantly different between meadows (ANOVA, $p < 0.05$), although no temporal trends were observed (Figs. 1a, 1b). Grain size composition also showed significant differences between *Caulerpa racemosa* var. *cylindracea* and *Posidonia oceanica* with higher mean grain size in *C. racemosa* var. *cylindracea* (ANOVA, $p < 0.05$) (Figs. 2a, 2b). A clear seasonal pattern was observed for *Caulerpa racemosa* var. *cylindracea* with maximal biomass in the months with warmest water temperatures and null biomass during the coldest months. It should be noted that 2004 was warm, and during December, the water temperature was over 20°C, thus affecting the seasonal biomass of *Caulerpa* (Fig. 3).

a

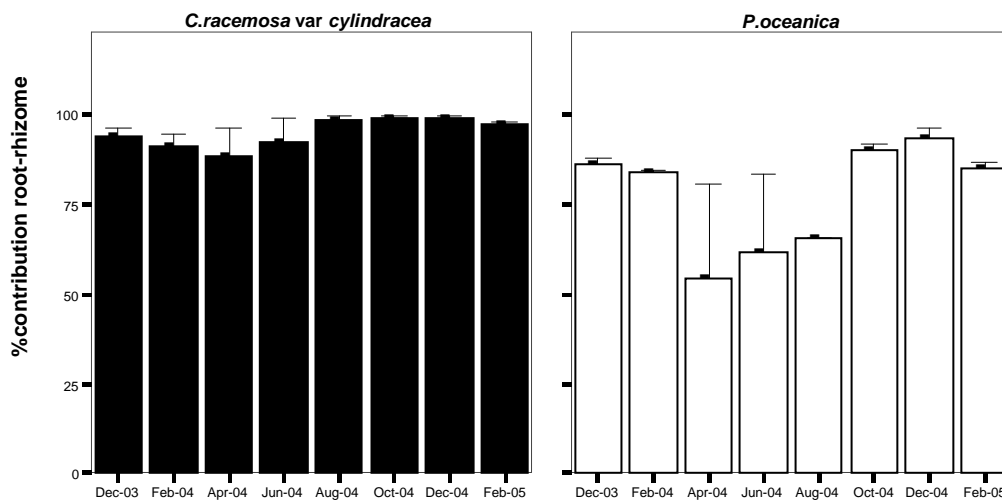

b

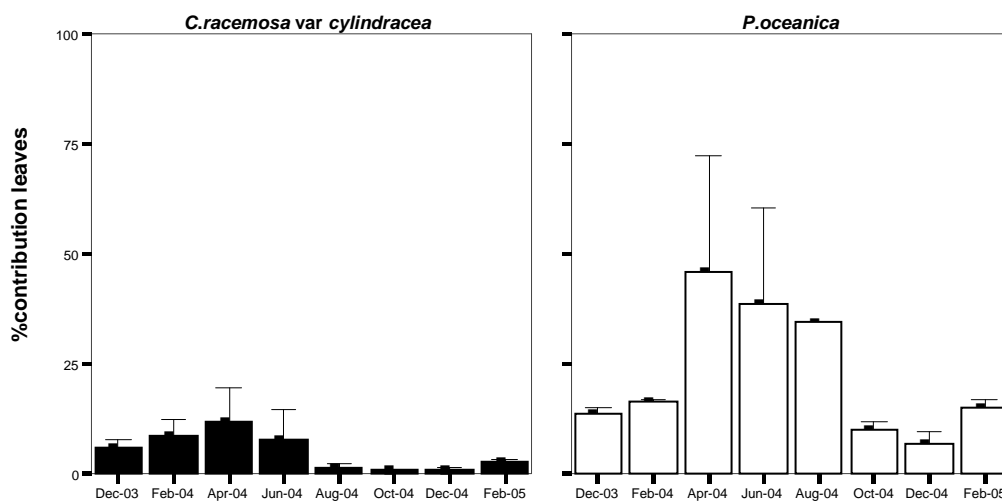
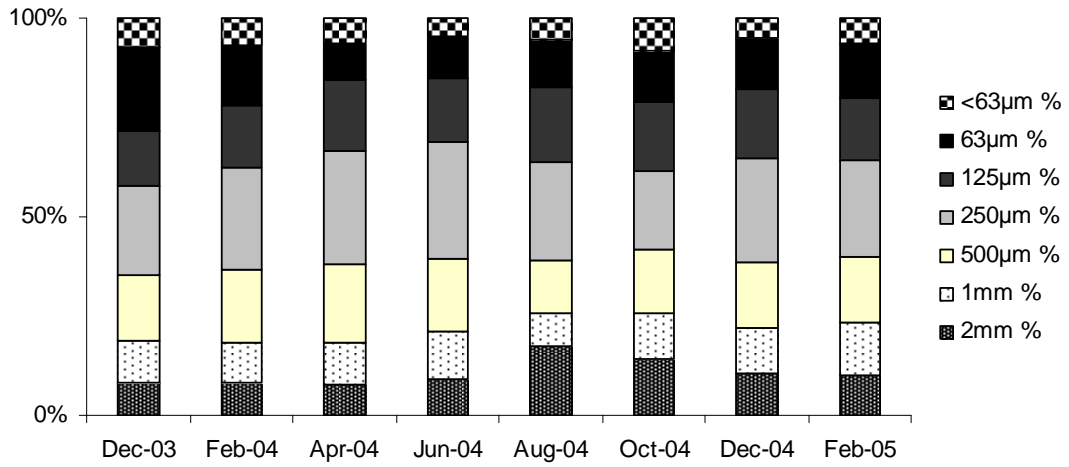

Figure 1: *Posidonia oceanica* percent contribution to samples in both meadows throughout the study period. (a) Percentage contribution of roots and rhizomes (b) contribution of leaves.

a



b

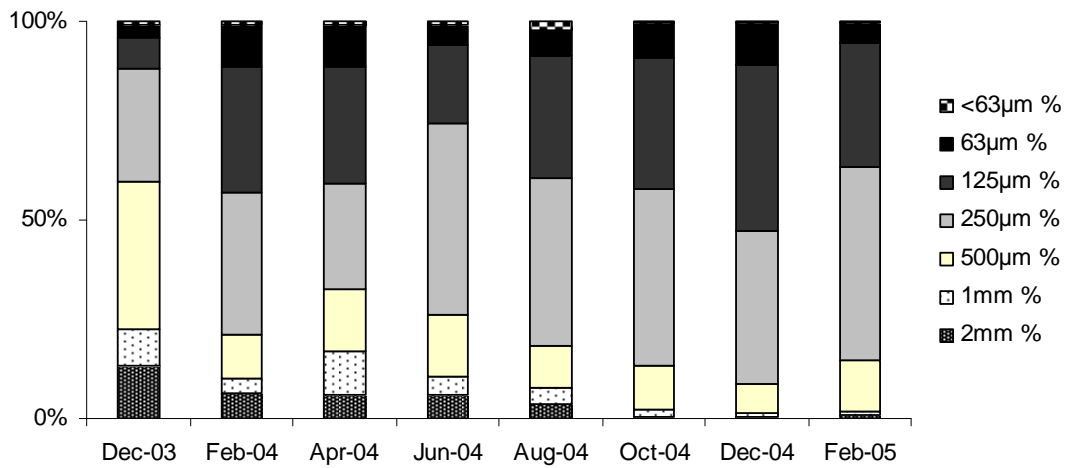

Figure 2: Seasonal variation in grain size (a) in *Caulerpa racemosa* var. *cylindracea* (b) *Posidonia oceanica*.

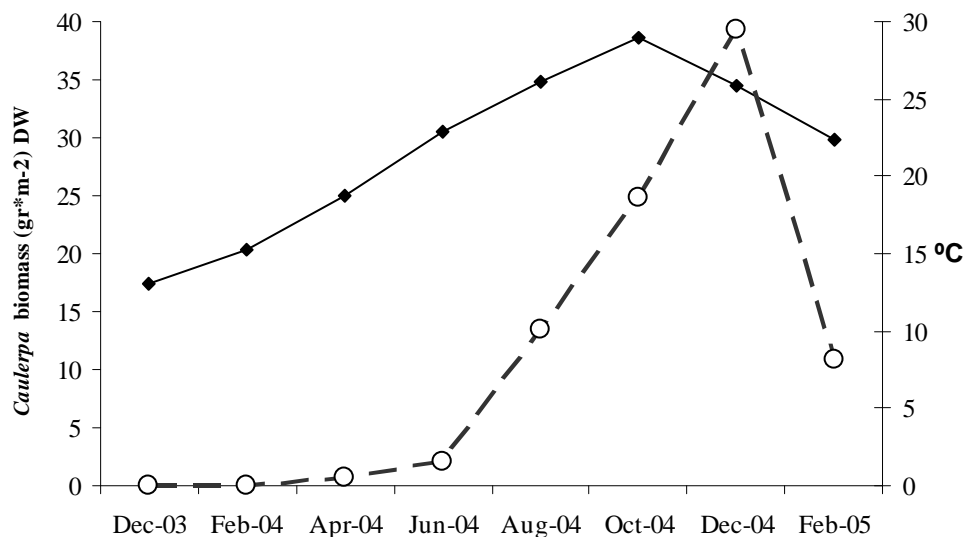

Figure 3: Seasonality of *Caulerpa racemosa* var. *cylindracea* biomass expressed as dry weight (DW) (discontinuous line) with water temperature (continuous line).

The sampling area located in Portals Vells was approximately 1,000 m². This area was characterised by the presence of a *Posidonia oceanica* seagrass bed with sandy areas and dead seagrass mats. The maximum estimated extension of substrates colonised by *C. racemosa* var. *cylindracea* was 403 m². Maximum coverage of this area occurred during October 2004, with the highest *C. racemosa* var. *cylindracea* biomass.

Mollusc community

A total of 1,925 individual molluscs comprising 37 species were collected in the *C. racemosa* var. *cylindracea* mats (Table 1). Twenty bivalve species and thirty-seven gastropod species were identified in *Caulerpa* mats. The dominant species (dominance higher than 1%) of gastropods were *Bittium reticulatum*, *Alvania cimex*, *Ascobulla fragilis*, *Nassarius incrassatus*, *Smaragdia viridis*, *Rissoina bruguieri*, *Cerithium vulgatum* and *Gibbula ardens* and for bivalves *Glans trapezia*, *Ctena decussata*, *Loripes lacteus*, *Limaria hians*, *Venerupis aurea*, *Venus verrucosa* and *Musculus costulatus* were the most abundant (Table 1).

Table 1: Seasonal mollusc assemblages in the *Caulerpa racemosa* var *cylindracea* meadow. Results are expressed as individuals/m². N indicates the total number of individuals/m², D indicates dominance values (number of individuals of each species/total individuals), F is the frequency of appearance (number of samples with presence of species/ total samples).

	Jul-03	Oct-03	Dec-03	Feb-04	Apr-04	Jun-04	Ago-04	Oct-04	Nov-04	Dec-04	Feb-05	N	D	F
Gastropoda														
<i>Bittium reticulatum</i>	0	0	0	0	0	8	0	17	8	8	92	133	6,61	45,45
<i>Alvania cimex</i>	0	17	0	8	8	0	8	17	0	0	0	58	2,89	45,45
<i>Ascobulla fragilis</i>	25	33	0	0	0	0	0	0	33	33	0	124	6,20	36,36
<i>Nassarius cf incrassatus</i>	0	17	0	0	0	0	17	8	0	0	33	75	3,72	36,36
<i>Smaragdia viridis</i>	0	0	58	0	0	0	0	0	8	0	8	74	3,72	27,27
<i>Rissoina bruguieri</i>	0	0	0	0	17	0	33	8	0	0	0	58	2,89	27,27
<i>Cerithium vulgatum</i>	0	8	8	0	0	8	0	0	0	0	0	24	1,24	27,27
<i>Gibbula ardens</i>	0	25	0	8	0	0	0	0	0	0	0	33	1,65	18,18
<i>Opisthobranchia</i> sp	0	0	0	0	0	0	0	0	0	8	17	25	1,24	18,18
<i>Alvania montagui</i>	0	0	0	17	0	0	0	0	0	0	0	17	0,83	9,09
<i>Alvania cancellata</i>	0	0	0	0	0	0	8	0	0	0	0	8	0,41	9,09
<i>Cylichna cylindracea</i>	0	0	0	0	0	8	0	0	0	0	0	8	0,41	9,09
<i>Mangelia multilineolata</i>	0	8	0	0	0	0	0	0	0	0	0	8	0,41	9,09
<i>Metaxia cf mataxa</i>	0	0	0	0	0	0	0	0	0	0	8	8	0,41	9,09
<i>Petalifera petalifera</i>	0	0	0	0	0	8	0	0	0	0	0	8	0,41	9,09
<i>Payraudeautia intricata</i>	0	0	0	0	0	0	0	8	0	0	0	8	0,41	9,09
<i>Tricolia pullus</i>	0	8	0	0	0	0	0	0	0	0	0	8	0,41	9,09
Bivalvia														
<i>Glans trapezia</i>	100	108	33	0	150	33	75	67	125	58	100	849	42,15	90,91
<i>Ctena decussata</i>	17	0	8	0	8	25	0	8	25	25	0	115	5,79	63,64
<i>Loripes lacteus</i>	17	0	8	0	8	0	0	0	8	0	8	49	2,48	45,45
<i>Limaria hians</i>	0	8	0	0	8	0	8	0	8	8	0	40	2,07	45,45
<i>Venerupis aurea</i>	8	0	0	0	8	8	0	0	0	0	8	32	1,65	36,36

<i>Venerupis</i> juv. Forms	0	0	0	0	0	0	0	8	8	8	0	24	1,24	27,27
<i>Venus verrucosa</i>	8	0	0	0	0	0	8	8	0	0	0	24	1,24	27,27
<i>Musculus costulatus</i>	0	0	0	0	0	0	0	0	17	0	17	34	1,65	18,18
<i>Arca noae</i>	0	0	0	0	8	8	0	0	0	0	0	16	0,83	18,18
<i>Modiolus barbatus</i>	0	0	0	0	8	0	0	0	8	0	0	16	0,83	18,18
<i>Musculus</i> juv. forms	0	0	0	0	0	0	8	8	0	0	0	16	0,83	18,18
<i>Modiolarca subpicta</i>	0	0	0	0	0	0	0	0	0	8	8	16	0,83	18,18
<i>Parvicardium exiguum</i>	0	0	0	0	0	0	0	0	25	0	0	25	1,24	9,09
<i>Barbatia barbata</i>	0	0	0	0	0	0	8	0	0	0	0	8	0,41	9,09
<i>Venericardia antiquata</i>	0	0	0	0	0	0	0	8	0	0	0	8	0,41	9,09
<i>Chama gryphoides</i>	0	0	0	0	0	0	8	0	0	0	0	8	0,41	9,09
<i>Donax</i> sp.	0	0	0	0	0	0	0	0	0	0	8	8	0,41	9,09
<i>Lucinella divaricata</i>	0	0	8	0	0	0	0	0	0	0	0	8	0,41	9,09
<i>Parvicardium scriptum</i>	8	0	0	0	0	0	0	0	0	0	0	8	0,41	9,09
<i>Striarca lactea</i>	0	0	0	0	0	0	0	8	0	0	0	8	0,41	9,09

Gastropod species *Bittium reticulatum*, *Alvania cimex*, *Ascobulla fragilis*, *Nassarius incrassatus*, *Smaragdia viridis*, *Rissoina bruguieri* and *Cerithium vulgatum* and bivalve species *Glans trapezia*, *Ctena decussata*, *Loripes lacteus*, *Limaria hians*, *Venerupis aurea* and *Venus verrucosa* had frequencies of appearance higher than 25% (Table 1).

There was evidence of significant differences in the number of mollusc species, in mollusc diversity and in mollusc abundance between *Caulerpa racemosa* var. *cylindracea* and *Posidonia oceanica* habitats. Higher abundances, more species and greater diversity were observed in the *C. racemosa* var. *cylindracea* area than in the *P. oceanica* area (ANOVA, $p < 0.05$) (Table 2, Figs. 4a – 4c). In the *C. racemosa* var. *cylindracea* area, a higher number of species was found in October (five gastropod and seven bivalve species) and a lower number was found on February 2003 with only three gastropod species and no bivalve species. The abundances in *C. racemosa* followed a different seasonal trend with maximum abundances found during February 2005 when *Caulerpa* decreased in biomass; abundance was especially influenced by the presence of *Bittium reticulatum* (92 individuals/m²) and *Glans trapezia* (100 individuals/m²) (Fig. 4 c).

Table 2. ANOVA results for total number of species of mollusc (per sample) and Shannon diversity index. * $p < 0.05$ NS Not significant.

Source of variation	df	Number species (per sample)(n=6)			df	Shannon-Wiener index H' (per sample)(n=6)		
		Mean	F	p		Mean	F	p
		square				square		
Meadow	1	52.56	7.08	NS	1	1.65	4.54	NS
Time	7	0.741	0.10	*	7	0.11	0.291	*
Meadow*time	7	17.24	2.32	*	7	1.11	3.06	*
Residual	48	7.43			48	0.36		

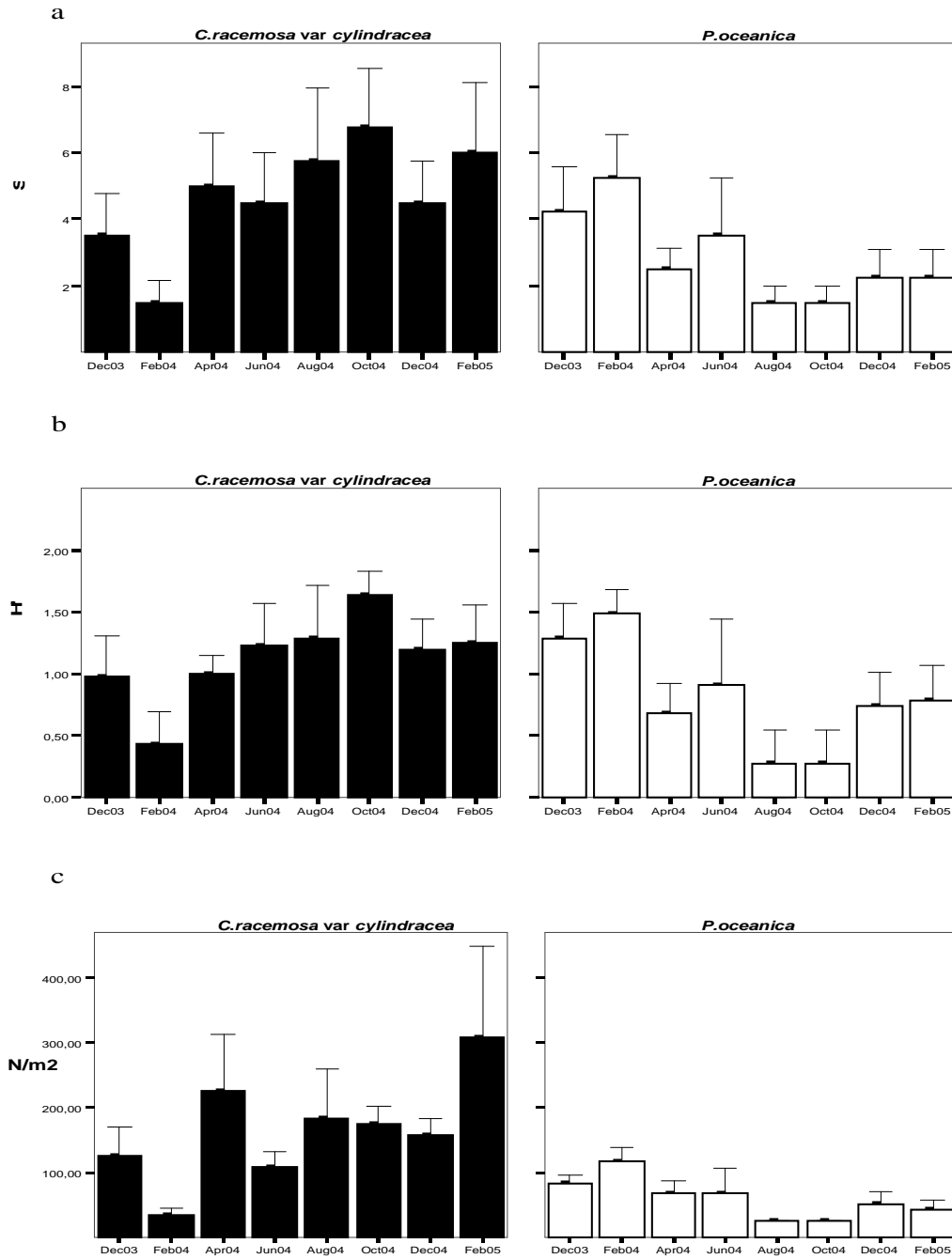

Figure 4: Seasonal changes in molluscs species at *Caulerpa racemosa* var. *cylindracea* and *Posidonia oceanica* areas for (a) number of species, (b) Shannon index and (c) number of individuals/m².

Cluster analysis indicated a clear separation between *Caulerpa racemosa* var. *cylindracea* samples and *P. oceanica* samples except for one sample from *C. racemosa* var. *cylindracea* from February 2004 and one sample of *P. oceanica* from August 2004. ANOSIM indicated that assemblages sampled from the two mats were significantly different (Global R = 0.537; $p < 0.001$) (Fig. 5). SIMPER analysis showed an average dissimilarity of 79.43% between mollusc samples from the *C. racemosa* mat and the seagrass bed of *P. oceanica*. The most important species contributing to the dissimilarity percentage were the bivalves *Glans trapezia* and *Ctena decussata*, which contributed more than 6% to the dissimilarity percentage. Overall, the observed differences from the two studied mats were mainly due to coincident species with substantial differences in abundance. The abundance was usually higher in the *C. racemosa* var *cylindracea* area than in the *P. oceanica* seagrass bed (Table 3).

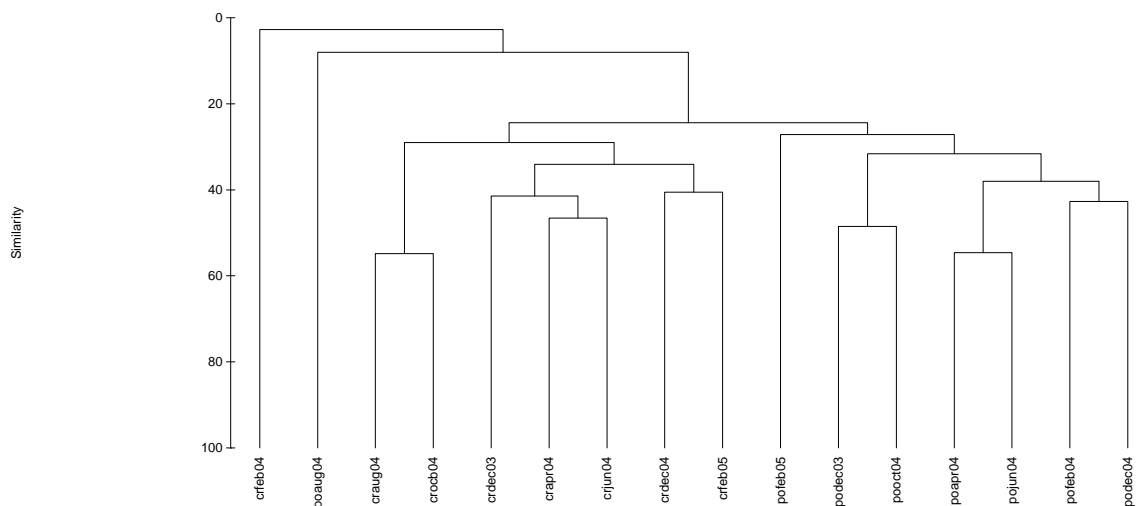

Figure 5: Cluster dendrogram representation of *Caulerpa racemosa* var *cylindracea* and *Posidonia oceanica* seasonal samples. cr means *C. racemosa* var. *cylindracea* and po means *P. oceanica*.

Table 3: Results of the SIMPER analysis for the mollusc species attaining the highest dissimilarity values between the two groups of samples taken from the two habitats. AA average abundance, AD average dissimilarity between *Caulerpa* and *Posidonia*, AD/SD ratio of the average dissimilarity/ standard deviation of dissimilarity for a species. The percentage of contribution to the dissimilarity between habitats is expressed in Contribution column.

Species	AA <i>Caulerpa</i>	AA <i>Posidonia</i>	AD	AD/SD	Contribution
<i>Glans trapezia</i>	71.30	16.67	5.12	1.20	6.45
<i>Ctena decussata</i>	11.11	0.00	4.98	1.31	6.27
<i>Bittium reticulatum</i>	14.81	1.04	3.90	1.05	4.90
<i>Loripes lacteus</i>	3.70	6.25	3.68	0.93	4.63
<i>Smaragdia viridis</i>	8.33	3.13	3.38	0.77	4.26
<i>Alvania cimex</i>	4.43	0.00	3.37	0.80	4.25
<i>Arca noae</i>	1.85	4.17	3.33	0.91	4.19
<i>Rissoina bruguieri</i>	6.48	1.04	2.79	0.75	3.51
<i>Striarca lactea</i>	0.93	4.17	2.72	0.77	3.42
<i>Limaria hians</i>	3.70	0.00	2.70	0.87	3.40
Eulimidae sp.	0.00	3.13	2.39	0.72	3.01
<i>Musculus costulatus</i>	3.70	2.08	2.26	0.75	2.85
<i>Nassarius incrassatus</i>	6.48	0.00	2.20	0.69	2.78
<i>Venerupis</i> juv. form	2.78	1.04	2.20	0.75	2.77
<i>Cerithium vulgatum</i>	1.85	1.04	2.16	0.61	2.72
<i>Modiolus barbatus</i>	1.85	2.08	2.16	0.73	2.72
<i>Venerupis aurea</i>	2.78	0.00	2.07	0.69	2.60
<i>Pinna nobilis</i>	0.00	2.08	1.92	0.54	2.42
<i>Ascobulla fragilis</i>	7.41	0.00	1.89	0.52	2.38
Polyplacophora sp.	0.00	4.17	1.82	0.55	2.30
<i>Venus verrucosa</i>	1.85	1.04	1.73	0.62	2.18
<i>Parvicardium exiguum</i>	2.78	1.04	1.57	0.50	1.97
<i>Alvania montagui</i>	1.85	0.00	1.55	0.34	1.95
Opisthobranchia sp.	2.78	0.00	1.44	0.53	1.81
<i>Chama gryphoides</i>	0.93	1.04	1.42	0.48	1.78
<i>Modiolarca subpicta</i>	1.85	0.00	1.33	0.52	1.68
<i>Gibbula ardens</i>	0.93	0.00	1.30	0.34	1.64
<i>Musculus</i> juv. forms	1.85	0.00	1.26	0.53	1.58
<i>Musculus laevigatus</i>	0.00	1.04	0.92	0.36	1.19
<i>Tricolia pullus</i>	0.00	1.04	0.92	0.36	1.16
<i>Lucinella divaricata</i>	0.93	0.00	0.89	0.35	1.12
<i>Petalifera petalifera</i>	0.93	0.00	0.78	0.35	0.98

Pearson correlations among variables *Caulerpa* biomass, water temperature, species number, diversity and abundances showed that temperature was positively correlated with *Caulerpa racemosa* var. *cylindracea* biomass (Rho=0.746, sig 0.01), with the number of species (Rho=0.371, sig 0.05) and with diversity (Rho=0.437, sig 0.05). No correlations were found between diversity indexes and *Caulerpa* biomass, but both were correlated with temperature, thus suggesting an indirect effect of *Caulerpa racemosa* var. *cylindracea* on mollusc community dynamics.

Discussion

This study demonstrated that in areas invaded by *Caulerpa racemosa* var. *cylindracea*, the mollusc community differs from that in those not invaded areas (i.e., *Posidonia oceanica* seagrass meadows). Multivariate analyses indicated that differences in the mollusc community between meadows were mainly due to changes in mollusc abundances, which were significantly higher in the area invaded by *C. racemosa* var. *cylindracea*.

Caulerpa racemosa var. *cylindracea* habitat and *Posidonia* seagrass meadows showed differences in the contributions of *P. oceanica* fractions and grain size parameters. The phases of vegetative growth were also reversed between the species (Dumay et al. 2002). Altogether, the significant differences in the physical and biological properties of the mat substratum must be considered, at least in part, to explain the differences in the mollusc assemblages of *Caulerpa racemosa* var. *cylindracea* compared to a similar area with *Posidonia oceanica* seagrass. *Posidonia oceanica* meadows are a complex ecosystem and more than 100 mollusc species are commonly found (Templado et al. 2004), but a larger sampling area should be considered to thoroughly study the seagrass community.

Some of the molluscan species identified in *Caulerpa racemosa* var. *cylindracea* such as *Bittium reticulatum*, *Smaragdia viridis*, *Ascobulla fragilis*, *Cerithium vulgatum*, *Loripes lacteus*, *Venerupis aurea*, *Arca noae*, *Parvicardium exiguum* and *Lucinella divaricata* were previously reported for *C. racemosa* mats in the Mediterranean Sea (Pandolfo and Chemello 1995; Argyrou et al. 1999; Buia et al. 2001). Many of the mollusc species found in *C. racemosa* var. *cylindracea* mats were also common in the

Western Mediterranean *Posidonia oceanica* seagrass beds (Templado 1984; Ballesteros et al. 1987; Chessa et al. 1989; Dantart et al. 1990; Scipione et al. 1996; Templado et al. 2004). Therefore, the mollusc community in *C. racemosa* var. *cylindracea* mats was highly influenced by the taxocenosis of molluscs living in nearby seagrass patches and also by photophilous algae (Ballesteros and Pinedo 2004). Among all mollusc species recorded in this study, only *Ascobulla fragilis* could be considered as strictly a *Caulerpa* specialised feeder (Gavagnin et al. 2000). The presence of *A. fragilis* in *C. racemosa* var. *cylindracea* confirms its adaptation to include the invasive macroalgae in its diet.

The general trend in the mollusc assemblages in *C. racemosa* var. *cylindracea* is higher diversity when the macroalgae covers the nude substrate (from June 04 to December 04). In winter, from December 03 to April 04 lower diversity values were recorded in the invasive macroalgae, but in the same period, *Posidonia oceanica* shows higher diversity. Our results show that a period of nude substratum presents lower diversities than the seagrass meadows. The increased mollusc diversities are associated with the vegetal coverage of the substrate. The vegetative cover over soft bottoms from dead *Posidonia* mats and sand enhances sediment stabilisation and a greater accumulation of organic matter occurs here compared to non-vegetated substrates (Rueda and Salas 2003). This results in significantly higher species richness, abundance and biomass in vegetated habitats in temperate and cold areas (Edgar et al. 1994; Boström and Bonsdorff 1997). *C. racemosa* var. *cylindracea* covers substrate and horizontal displacement of fauna from the seagrass beds and the photophilous algae community towards the *Caulerpa* mat could explain the high coincidences in the species composition found.

Most of the differences between *C. racemosa* var. *cylindracea* and *P. oceanica* were due to differences in mollusc abundances, such as for *Glans trapezia*, *Ctena decussata*, *Alvania cimex* and *Rissoina bruguieri*, with higher abundances in *C. racemosa* var. *cylindracea* than in *P. oceanica*. Moreover, *Arca noae* and *Striarca lactea* had higher abundances in *P. oceanica* compared to *C. racemosa*. Both species are well adapted to live in the *P. oceanica* rhizome stratum (Chimenz et al. 1989; Templado et al. 2004). The mollusc diversity and abundances in *P. oceanica* observed in this work, particularly for gastropods, were low compared to previous work focused mainly on the invertebrate community of the foliar stratum (Chessa et al. 1989; Gambi et al. 1992; Scipione et al. 1996; Sanchez-Jerez et al. 1999a). These differences resulted from

the sampling methodology, which was appropriate for *Caulerpa* mats, but not for sampling seagrass (*P. oceanica*).

At the end of the summer and in early autumn, *Caulerpa racemosa* var. *cylindracea* covers *P. oceanica* rhizomes as well as the sandy bottoms in the studied area. Fronds and stolons of *C. racemosa* cover the dead seagrass mat layer and generate a more complex habitat associated with the invasive algae. Pearson correlations showed the most important variable to be temperature, which was positively correlated with mollusc species number and diversity, and with *C. racemosa* biomass. The lack of correlation between biomass and community descriptor variables may be related to the negative effect of high biomass of algae over bivalves. Sanchez-Moyano et al. (2001) reported a negative effect of maximum *C. prolifera* biomass values over bivalves.

For *Caulerpa taxifolia*, the other Mediterranean invasive *Caulerpa* species, a decrease in specialist grazers such as *Mullus surmuletus* (fish) occurs due to the complex algal structure that prevents the fish from reaching food sources (Levi and Francour 2004; Longepierre et al. 2005). All invertebrate predators with morphological feeding adaptations encounter a structural barrier built by the *Caulerpa* mats and stolons that make it difficult to access the food source. An example of this was in Australia, where it had been reported that the presence of invasive *Caulerpa taxifolia* reduced the number of syngnathids and monocanthids compared to the number found in seagrass beds (York et al. 2006). *Caulerpa racemosa* var. *cylindracea* develops similar complex algal structures with similar effects on *M. surmuletus* and other benthic-feeding fishes, but with a sharp decrease in *C. racemosa* biomass during the winter. Mollusc species increased in abundance with the presence of a *Caulerpa* mat. The highest abundance of molluscs in *C. racemosa* var. *cylindracea* was during February 2005 and did not follow the seasonal biomass trends. Therefore, other factors, such as the *C. racemosa* var. *cylindracea* biomass degradation, may be related to seasonal changes in abundances of molluscs. *Bittium reticulatum* had the highest abundance of all sampling months in February. These abundances may be due to *Caulerpa* biomass degradation and the loss of chemical defences (Dumay et al. 2002) that enable ingestion by the herbivorous detritivore *Bittium reticulatum*. This gastropod species can feed on *Caulerpa* spp. without antioxidant damage (Sureda et al. 2008).

The results obtained in this study clearly indicate that there is an effect of the invasive macroalgae *C. racemosa* var. *cylindracea* on the mollusc community; this agrees with results found by Buia et al. (2001). The results of this study seem to indicate

that bivalves are favoured by the presence of the invasive macroalgae in accordance with results reported by Argyrou et al. (1999). The mollusc community is clearly related to the seasonal trends of *C. racemosa* var. *cylindracea* biomass; this is consistent with previous work on *C. racemosa* (Buia et al. 2001). Several works have emphasised the importance of algal cover on the substratum, which increases invertebrate abundances and diversity (Connolly 1997; Sanchez-Jerez et al. 1999b; Gribben and Wright 2006). Previous work on other *Caulerpa* species found higher abundances and diversity when the algae attained maximum biomass (Rueda et al. 2001; Rueda and Salas 2003).

Posidonia oceanica has a high ecological value (Buia et al. 2000) that fulfils many ecological functions not supported by *Caulerpa racemosa* var. *cylindracea*, as it functions as a nursery for many species (Harmelin-Vivien 1982; Harmelin-Vivien 1984; Mazzella et al. 1986). *Caulerpa racemosa* var. *cylindracea* is known to be a successful invader (Boudouresque and Verlaque 2002; Galil 2007). Its rapid growth allows it to overgrow other macroalgae and to change macroalgae assemblages (Piazzi et al. 2001; Piazzi et al. 2003; Piazzi and Balata 2008) resulting in the replacement of the dominant *P. oceanica* community within six years (Argyrou et al. 1999). This is the first study to compare mollusc composition in *C. racemosa* areas and in seagrass beds. We found a diversification of the mollusc community in *C. racemosa* var. *cylindracea* compared to the community in *P. oceanica* due to the presence of several species of the nearby taxocoenosis within the *C. racemosa* var. *cylindracea* area. It is also important to note that the effect of the *Caulerpa* biomass on the invertebrate community resulted in higher diversity values related to the maximum *Caulerpa* biomass. The effect of invasive species on Mediterranean species must be studied in more detail and long-term monitoring programs should be instituted to evaluate the spatial and temporal effects on mollusc communities associated with the presence of *C. racemosa* var. *cylindracea*.

Acknowledgements

This research was funded by the Science and Technology Ministry (Plan Nacional I+D, REN 2002-0001/MAR). The first author was funded by postgraduate research grant I3P FSE. We are most grateful to P. Sarriera, A. Sureda, A. Frau, C. Alonso, J. Terrados and N. Marba for their help with sample collection.

References

- Amade P., Lemee R., 1998. Chemical defence of the Mediterranean alga *Caulerpa taxifolia*: variations in caulerpenyne production. *Aquatic Toxicology* 43: 287-300.
- Argyrou M., Demetropoulos A., Hadjichristophorou M., 1999. Expansion of the macroalga *Caulerpa racemosa* and changes in softbottom macrofaunal assemblages in Moni Bay, Cyprus. *Oceanologica Acta* 22: 517-528.
- Ballesteros E., Grau A. M., Riera F., 1999. *Caulerpa racemosa* (Forsskal) J. Agardh (Caulerpales, Chlorophyta) in Mallorca (Western Mediterranean). *Bolletí Societat d'Història Natural de les Illes Balears* 42: 63-69.
- Ballesteros E., Pinedo S., 2004. Los bosques de algas pardas y rojas. In: Consejería de Medio Ambiente (ed). *Praderas y Bosques Marinos de Andalucía*, Sevilla
- Ballesteros M., Castelló J., Gallés M., Sarda R., 1987. Invertebrados alguícolas marinos de las islas pitiusas. *Conselleria de Medio Ambiente*, Ibiza.
- Bellan-Santini D., Arnaud P. M., Bellan G., Verlaque M., 1996. The influence of the introduced tropical alga *Caulerpa taxifolia*, on the biodiversity of the Mediterranean marine biota. *Journal of the Marine Biological Association of the United Kingdom* 76: 235-237.
- Borg J. A., Rowden A. A., Attrill M. J., Schembri P. J., Jones M. B., 2006. Wanted dead or alive: high diversity of macroinvertebrates associated with living and 'dead' *Posidonia oceanica* matte. *Marine Biology* 149: 667-677.
- Boström C., Bonsdorff E., 1997. Community structure and spatial variation of benthic invertebrates associated with *Zostera marina* (L.) beds in the northern Baltic Sea. *Journal of Sea Research*. 37: 153-166.
- Boudouresque C. F., Lemee R., Mari X., Meinesz A., 1996. The invasive alga *Caulerpa taxifolia* is not a suitable diet for the sea urchin *Paracentrotus lividus*. *Aquatic Botany* 53: 245-250.
- Boudouresque C. F., Verlaque M., 2002. Biological pollution in the Mediterranean Sea: invasive versus introduced macrophytes. *Marine Pollution Bulletin* 44: 32-38.
- Buia M. C., Gambi M. C., Terlizzi A., Mazzella L., 2001 Colonization of *Caulerpa racemosa* along the southern Italian coast: I. Distribution, phenological variability and ecological role. In: Gravez V, Ruitton S, Boudouresque CF, Le

- Direac'h L, Meinesz A, G. S (eds) Fourth International Workshop on *Caulerpa taxifolia*. GIS Posidonie, France, pp 352-360
- Buia M. C., Gambi M. C., Zupo V., 2000. Structure and functioning of mediterranean seagrass ecosystems: an overview. *Biologia Marina Mediterranea* 7: 167-190.
- Buschmann, A.H., 1990. Intertidal Macroalgae as Refuge and Food for Amphipoda in Central Chile. *Aquatic Botany* 36 (3), 237-245.
- Connolly R. M., 1997. Differences in composition of small, motile invertebrate assemblages from seagrass and unvegetated habitats in a southern Australian estuary. *Hydrobiologia* 346: 137-148.
- Chessa L. A., Bionda G., Buia M. C., Gambi C., Lorenti M., Maj R., Manconi R., Martinelli M., Pintus M. G., Russo G. F., Scipione M. B., Taramelli E., 1989. Indagini su *Posidonia oceanica* nella rada di Porto Conte (Sadezna Nord-Occidentale): Caratteristiche della prateria e fauna vagile. *Oebalia* XV: 99-107.
- Chimenz C., Taramelli E., Cironi R., Contessini A., Gravina F., Maggiore F., Maj R., Motta M., Somaschini A., 1989 Studies on animal populations of leaves and rhizomes of *Posidonia oceanica* (L.) Delile on the rocky bottom of Torvaldaliga. In: Boudouresque CF, Meinesz A, Fresi E, Gravez V (eds) International Workshop on Posidonia Beds. G.I.S Posidonie, Ischia (Italy), pp 145-155
- Dantart M., Frechilla M., Ballesteros M., 1990. Fauna malacologica del Estany des Peix (Formentera). *IBERUS* 9: 111-125.
- Dumay O., Pergent G., Pergent-Martini C., Amade P., 2002. Variations in caulerpenyne contents in *Caulerpa taxifolia* and *Caulerpa racemosa*. *Journal of Chemical Ecology* 28: 343-352.
- Edgar G. J., Shaw C., Watson G. F., Hammond L. S., 1994. Comparisons of Species Richness, Size-Structure and Production of Benthos in Vegetated and Unvegetated Habitats in Western-Port, Victoria. *Journal of Experimental Marine Biology and Ecology* 176: 201-226.
- Galil B. S., 2007. Loss or gain? Invasive aliens and biodiversity in the Mediterranean Sea. *Marine Pollution Bulletin* 55: 314-322.
- Gambi M. C., Lorenti M., Russo G. F., Scipione M. B., Zupo V., 1992. Depth and Seasonal Distribution of Some Groups of the Vagile Fauna of the *Posidonia oceanica* Leaf Stratum - Structural and Trophic Analyses 13: 17-39.

- Gavagnin M., Mollo E., Montanaro D., Ortea J., Cimino G., 2000. Chemical studies of Caribbean sacoglossans: Dietary relationships with green algae and ecological implications. *Journal of Chemical Ecology* 26: 1563-1578.
- Gollasch S., 2006. Overview on introduced aquatic species in European navigational and adjacent waters. *Helgoland Marine Research* 60: 84-89.
- Gribben P. E., Wright J. T., 2006. Invasive seaweed enhances recruitment of a native bivalve: roles of refuge from predation and the habitat choice of recruits. *Marine Ecology-Progress Series* 318: 177-185.
- Harmelin-Vivien M., 1982. Ichtyofaune des herbiers à *Posidonia oceanica* du parc national de Port-Cros. I. Composition et variations spatio-temporelles. *Trav Sci Parc Nation Port-Cros* 8: 69-72.
- Harmelin-Vivien M., 1984. Ichtyofaune des herbiers de Posidonies du parc naturel regional de Corse. In: Boudouresque CF, A. dG, Olivier J (eds) International workshop on *Posidonia oceanica* beds. GIS Posidonie Publications, France, pp 291-301
- Jung V., Thibaut T., Meinesz A., Pohnert G., 2002. Comparison of the wound-activated transformation of caulerpenyne by invasive and noninvasive *Caulerpa* species of the Mediterranean. *Journal of Chemical Ecology* 28: 2091-2105.
- Levi F., Francour P., 2004. Behavioural response of *Mullus surmuletus* to habitat modification by the invasive macroalga *Caulerpa taxifolia*. *Journal of Fish Biology* 64: 55-64.
- Longepierre S., Robert A., Levi F., Francour P., 2005. How an invasive alga species (*Caulerpa taxifolia*) induces changes in foraging strategies of the benthivorous fish *Mullus surmuletus* in coastal Mediterranean ecosystems. *Biodiversity and Conservation* 14: 365-376.
- MacDougall A. S., Turkington R., 2005. Are invasive species the drivers or passengers of change in degraded ecosystems? *Ecology* 86: 42-55.
- Mack R. N., Simberloff D., Lonsdale W. M., Evans H., Clout M., Bazzaz F. A., 2000. Biotic invasions: Causes, epidemiology, global consequences, and control. *Ecological Applications* 10: 689-710.
- Mazzella L., Buia M. C., Gambi C., Lorenti L., Russo G. F., Scipione M. B., Zupo V., 1986. Plant-animal trophic relationships in the *Posidonia oceanica* ecosystem of the Mediterranean Sea: A Review. In: John DM, Hawkins SJ, Price JH (eds)

- Plant animal interactions in the Marine Benthos. Systematics Association Special Volume, Oxford, pp 165-187.
- Sanchez-Moyano J. E., Estacio F. J., Garcia-Adiego E. M., Garcia-Gomez J. C., 2001. Effect of the vegetative cycle of *Caulerpa prolifera* on the spatio-temporal variation of invertebrate macrofauna. *Aquatic Botany* 70: 163-174.
- Pandolfo A., Chemello R., 1995. Prime nota sulla malacofauna associata a *Caulerpa racemosa* nella Baia di Santa Panagia (Sicilia orientale). *Biologia Marina Mediterranea* 2: 649-651.
- ParentMassin D., Fournier V., Amade P., Lemee R., DurandClement M., Delescluse C., Pesando D., 1996. Evaluation of the toxicological risk to humans of caulerpenyne using human hematopoietic progenitors, melanocytes, and keratinocytes in culture. *Journal of Toxicology and Environmental Health* 47: 47-59.
- Pesando D., Huitorel P., Dolcini V., Amade P., Girard J. P., 1998. Caulerpenyne interferes with microtubule-dependent events during the first mitotic cycle of sea urchin eggs. *European Journal of Cell Biology* 77: 19-26.
- Pesando D., Lemee R., Ferrua C., Amade P., Girard J. P., 1996. Effects of caulerpenyne, the major toxin from *Caulerpa taxifolia* on mechanisms related to sea urchin egg cleavage. *Aquatic Toxicology* 35: 139-155.
- Piazzì L., Balata D., 2008. The spread of *Caulerpa racemosa* var *cylindracea* in the Mediterranean Sea: An example of how biological invasions can influence beta diversity. *Marine Environmental Research* 65: 50-61.
- Piazzì L., Balata D., Cecchi E., Cinelli F., 2003. Co-occurrence of *Caulerpa taxifolia* and *C. racemosa* in the Mediterranean Sea: interspecific interactions and influence on native macroalgal assemblages. *Cryptogamie Algologie* 24: 233-243.
- Piazzì L., Ceccherelli G., Cinelli F., 2001. Threat to macroalgal diversity: effects of the introduced green alga *Caulerpa racemosa* in the Mediterranean. *Marine Ecology-Progress Series* 210: 149-159.
- Piazzì L., Cinelli F., 1999. Development and seasonal dynamics of a population of the tropical alga *Caulerpa racemosa* (Forsskal) J. Agardh in the Mediterranean. *Cryptogamie Algologie* 20: 295-300.
- Rueda J. L., Fernandez-Casado M., Salas C., Gofas S., 2001. Seasonality in a taxocoenosis of molluscs from soft bottoms in the Bay of Cadiz (southern

- Spain). *Journal of the Marine Biological Association of the United Kingdom* 81: 903-912.
- Rueda J. L., Salas C., 2003. Seasonal variation of a molluscan assemblage living in a *Caulerpa prolifera* meadow within the inner Bay of Cadiz (SW Spain). *Estuarine Coastal and Shelf Science* 57: 909-918.
- Sakai A. K., Allendorf F. W., Holt J. S., Lodge D. M., Molofsky J., With K. A., Baughman S., Cabin R. J., Cohen J. E., Ellstrand N. C., McCauley D. E., O'Neil P., Parker I. M., Thompson J. N., Weller S. G., 2001. The population biology of invasive species. *Annual Review of Ecology and Systematics* 32: 305-332.
- Sanchez-Jerez P., Barbera-Cebrian C., Ramos-Espla A., 1999a. Daily vertical migrations in the epifauna associated with *Posidonia oceanica* meadows. *Journal of the Marine Biological Association of the United Kingdom* 79: 971-977.
- Sanchez-Jerez P., Cebrian C. B., Espla A. A. R., 1999b. Comparison of the epifauna spatial distribution in *Posidonia oceanica*, *Cymodocea nodosa* and unvegetated bottoms: Importance of meadow edges 20: 391-405.
- Scipione M. B., Gambi M. C., Lorenti M., Russo G. F., Zupo V., 1996 Vagile fauna of the leaf stratum of *Posidonia oceanica* and *Cymodocea nodosa* in the Mediterranean Sea. In: Kuo J, Phillips CP, Walker ID, Kirkman H (eds) *Seagrass biology, Rottneest Island, Western Australia*, pp 249-260
- Sureda A., Box A., Deudero S., Pons A., 2008. Reciprocal effects of caulerpenyne and intense herbivorism on the antioxidant response of *Bittium reticulatum* and *Caulerpa taxifolia*. *Ecotoxicology and Environmental Safety* in press: doi:10.1016/j.ecoenv.2007.1012.1007.
- Sureda A., Box A., Ensenat M., Alou E., Tauler P., Deudero S., Pons A., 2006. Enzymatic antioxidant response of a labrid fish (*Coris julis*) liver to environmental caulerpenyne. *Comparative Biochemistry and Physiology C-Toxicology & Pharmacology* 144: 191-196.
- Templado J., 1984 Las praderas de *Posidonia oceanica* en el sureste español y su biocenosis. In: Boudouresque CF, Jeudy De Grissac A, Olivier J (eds) 1st International Workshop on *Posidonia oceanica* beds. G.I.S Posidonie publications, France, pp 159-172
- Templado J., Ballesteros E., Garcia-Raso J. E., San Martin G. A., Lopez-Garcia L., Salas C., Luque A., Sanchez-Lizaso J. L., Moreno D., 2004. La comunidad

posidonícola. In: Luque del Villar AA, Templado J (eds) Praderas y Bosques Marinos de Andalucía. Consejería de Medio Ambiente, Junta de Andalucía, Sevilla.

Verlaque M., Afonso-Carrillo J., Gil-Rodríguez M. C., Durand C., Boudouresque C. F., Le Parco Y., 2004. Blitzkrieg in a marine invasion: *Caulerpa racemosa* var. *cylindracea* (Bryopsidales, Chlorophyta) reaches the Canary Islands (north-east Atlantic). *Biological Invasions* 6: 269-281.

Verlaque M., Durand C., Huisman J. M., Boudouresque C. F., Le Parco Y., 2003. On the identity and origin of the Mediterranean invasive *Caulerpa racemosa* (Caulerpales, Chlorophyta). *European Journal of Phycology* 38: 325-339.

York P. H., Booth D. J., Glasby T. M., Pease B. C., 2006. Fish assemblages in habitats dominated by *Caulerpa taxifolia* and native seagrasses in south-eastern Australia. *Marine Ecology-Progress Series* 312: 223-234.

Zuljevic A., Antolic B., Onofri V., 2003. First record of *Caulerpa racemosa* (Caulerpales : Chlorophyta) in the Adriatic Sea. *Journal of the Marine Biological Association of the United Kingdom* 83: 711-712.

2.3 How different is the mollusc community between invasive *Caulerpa taxifolia* (Chlorophyta: Caulerpaceae) and established *C. prolifera* in shallow seagrass beds of the Western Mediterranean?

Abstract

Differences in the mollusc communities on established *Caulerpa prolifera* macroalgal mats versus those found on the invasive *Caulerpa taxifolia* growing over shallow seagrass rhizomes over 2 years have been described in terms of community structure (species composition, diversity and abundance). Each *Caulerpa* species differed in biomass, associated sediment granulometry and contribution to seagrass fractions. Higher mollusc abundances were found in *C. prolifera* (3,617 ind/m² from 27 mollusc species) than *C. taxifolia* (1,450 ind/m² from 35 species). Both *Caulerpa* species had coincident mollusc species ranging from gastropods to bivalves, such as *Ascobulla fragilis*, *Loripes lacteus*, *Ctena decussata* and *Glans trapezia* that accounted for the main differences in the abundances. There were differences in the main trophic guilds between meadows with a dominance of herbivores and deposit feeders found in *C. prolifera* (such as *Ascobulla fragilis* and *Ctena decussata*), while *C. taxifolia* induced an increase in filter feeders (such as *Glans trapezia*). *Caulerpa prolifera* is characterised by higher mollusc abundances while *C. taxifolia* presents a more diverse mollusc species composition as would be expected from the initial colonization stages of an alien species.

Keywords: alien species; *Ascobulla fragilis*; *Caulerpa*; marine mollusc; Balearic Islands

Introduction

Biological invasions are considered to be among the most important human-caused global changes with important impacts on ecological, economic and social systems (Sakai et al. 2001; Occhipinti-Ambrogi and Savini 2003). The growth of international shipping, aquaculture and aquarium trade promotes the introduction of species in marine ecosystems (Boudouresque and Verlaque 2002). Invasive species alter biodiversity and change the structure of the invaded ecosystem (Mack et al. 2000; MacDougall and Turkington 2005). Invaders are usually highly competitive and, in their interaction with native species, may cause a severe reduction in ecosystem biodiversity (Bax et al. 2003).

In the Mediterranean, 84 introduced macrophytes are currently found (Boudouresque and Verlaque 2002). *Caulerpa taxifolia* (Vahl) C. Agardh is considered one of the most invasive species in the Mediterranean (Phillips and Price 2002), having been introduced in 1984 (Meinesz and Hesse 1991) and rapidly spreading across the Western Mediterranean basin (Meinesz et al. 2001). This species seems to interfere with the vegetative development of the endemic seagrass *Posidonia oceanica* L. Delile (Devillele and Verlaque 1995; Dumay et al. 2002) and reduces algal diversity in the invaded communities (Balata et al. 2004; Verlaque et al. 2004). It has thereby greatly altered the Mediterranean shallow benthic communities in certain locations (Meinesz et al. 1993; Meinesz 2004). In the Balearic Islands the first report of *C. taxifolia* was in 1992 at Cala d'Or Bay in water 6 m deep (Pou et al. 1993). Currently, its presence continues to be restricted to Cala d'Or Bay and no expansion had been observed.

Caulerpa prolifera is widespread throughout the Mediterranean basin (with the exception of the Lion Gulf and the Adriatic Sea). *Caulerpa prolifera* growth and spatial distribution are highly influenced by water temperature, as it is an algae with subtropical affinity (Sanchez-Moyano et al. 2004). This macroalgae covers soft bottoms from 1 to 20 meters depth, and it is mainly found in water with low flow and low hydrodynamic effects (Sanchez-Moyano et al. 2001a; Sanchez-Moyano et al. 2004).

The effect of the invasion of *Caulerpa taxifolia* over soft bottoms on the invertebrate macrofauna is still unknown; however, there are several studies of mollusc communities in *C. prolifera* (Rueda et al. 2001; Sanchez-Moyano et al. 2001a; Sanchez-Moyano et al. 2001b; Rueda and Salas 2003). The present study aims to increase the

understanding of the invertebrate molluscan fauna on soft bottoms colonised by the invader macroalgae *C. taxifolia*.

The aim of this study is to compare the mollusc invertebrate faunal community found in established *Caulerpa prolifera* habitat with the community found in introduced *C. taxifolia* habitat over a two-year period. The specific objectives are:

- Description of the species composition and abundances of molluscs from *C. prolifera* and from invasive *C. taxifolia*.
- Analysis of seasonal changes in mollusc abundance linked with changes in biomass of *Caulerpa* spp.

The present study represents the first comparison of malacological fauna on *C. prolifera* versus *C. taxifolia*, thus contributing to the elucidation of patterns and dynamics in pristine and invaded areas.

Materials and methods

Study area and sampling design

The study was carried out in Mallorca (Balearic Islands, Western Mediterranean). Two sites were selected with similar bathymetry: 5-8 meters depth and a similar hydrodynamic regime. The sampled substrate consisted of *Posidonia oceanica* rhizomes colonised by *Caulerpa prolifera* and *Caulerpa taxifolia*. The macroalgae *C. taxifolia* and *C. prolifera* were collected at Cala D'Or Bay, Southeast Mallorca (N 39° 22.164' / E 3° 13.887' and N 39° 22.028' / E 3° 13.739', respectively). In both areas *Caulerpa* mats do not form mono-specific mats but grow over *P. oceanica* rhizome patches on sandy bottoms and *Posidonia oceanica* seagrass meadows.

Six replicate samples per meadow and sampling date were collected bimonthly during the period from March 2003 until February 2005. Each sample was collected using a 20 x 20 cm stainless steel frame inserted 5 cm into the sediment, with a total sampling volume of 2,000 cm³ and a surface area of 400 cm². The frames were sampled by SCUBA during the morning hours (11-12 GTM). Samples were placed in a plastic 500-µm mesh bag until they were sorted in the laboratory.

At the same time as the collection of the faunal samples, three cores (diameter 3.5 cm) per meadow and sampling date were collected. The corer was inserted 5 cm into the sediment to characterise grain size parameters of the substrate.

Seawater temperature was recorded by StowAway[®] Tidbit[®] (Onset Computer Corporation, Pocasset, MA, USA) temperature loggers permanently installed at both sites.

Sample processing

Individual molluscs were sorted from the sediment and algal samples at the laboratory using a stereomicroscope and then kept in 70% ethanol and identified to the lowest taxonomic level possible. Algal components (fronds and stolons) from *Caulerpa* spp. and other seagrass (*Posidonia oceanica*) fractions contributing to plant biomass were sorted when they were present in the samples to quantify their biomass. *Posidonia oceanica* rhizomes, roots, sheaths and leaves were dried for 24 h at 60°C to estimate the percentage contribution to the aboveground (leaves and flowers) and belowground (roots, rhizomes and sheaths) structures. *Caulerpa* biomass for both species was dried for 24 h at 60° C to estimate the dry weight of algae in the samples.

Sediment grain size was estimated following the Wentworth scale after eliminating organic matter from samples using H₂O₂ and drying the samples for 24 h.

Statistical analyses

For community structural parameters, *Posidonia oceanica* components and grain size fraction differences between *Caulerpa prolifera* and *Caulerpa taxifolia* were tested using two-way ANOVA (factors: meadow (2 levels) and time (12 levels)). Differences in the number of mollusc species and abundances between meadows were tested using a two-way ANOVA (factors: meadow (2 levels) and time (12 levels)). Analyses were carried out using SPSS v. 15.0.

To analyse differences in mollusc species composition between *C. prolifera* and *C. taxifolia*, multivariate analyses were carried out on the species abundance data (pooled by meadow and date and 4th-root transformed to account for the contribution of dominant species) using PRIMER v. 5.0. A ranked triangular matrix was constructed using the Bray-Curtis similarity algorithm. A representation of the results was obtained with a Cluster similarity dendrogram. Differences between *C. prolifera* and *C. taxifolia* were tested by analysis of similarity (ANOSIM). The similarity percentages SIMPER

procedure was applied to analyse the highest contribution by mollusc species to the dissimilarity between meadows.

Dominance (D) (relative abundance of a particular species within a sample) was calculated for each bimonthly sample and for the total samples collected. The frequency index was calculated as the percentage of bimonthly samples in which a particular species was present over the sampling period. The number of individual samples, number of species, Shannon diversity index (H') (Krebs, 1989) and evenness index (J) (Pielou, 1969) were calculated for each sample by applying the DIVERSE routine (PRIMER 5.0). Means of the differences in the number of species, Shannon diversity index and abundances between meadows were tested using two-way ANOVA (factors: meadow and time). Pearson correlations were carried out to examine relationships between mollusc descriptor variables with temperature and *Caulerpa* biomass using SPSS 15.0.

Results

Characterization of algal mats

Statistical analyses showed no differences in the percentage contribution of *Posidonia oceanica* root-rhizomes and leaves between *Caulerpa prolifera* and *Caulerpa taxifolia* (Figs. 1a, 1b). There were differences among grain size fractions between *Caulerpa* species (ANOVA $p < 0.05$). The main grain size for *Caulerpa prolifera* was very fine sand while for *C. taxifolia* mats, there was a predominance of fine sand fractions (Figs. 2a, 2b).

Biomass followed different seasonal trends for *C. prolifera* and *C. taxifolia*. Higher biomass values in *C. prolifera* were found during February and March, while for *C. taxifolia*, higher biomass was found in July (2003) and December (2004). There were significant differences between *C. prolifera* and *C. taxifolia* biomass (higher for *C. prolifera*), seasonality and the interaction between biomass and seasonality (ANOVA, $p < 0.05$) (Fig. 3).

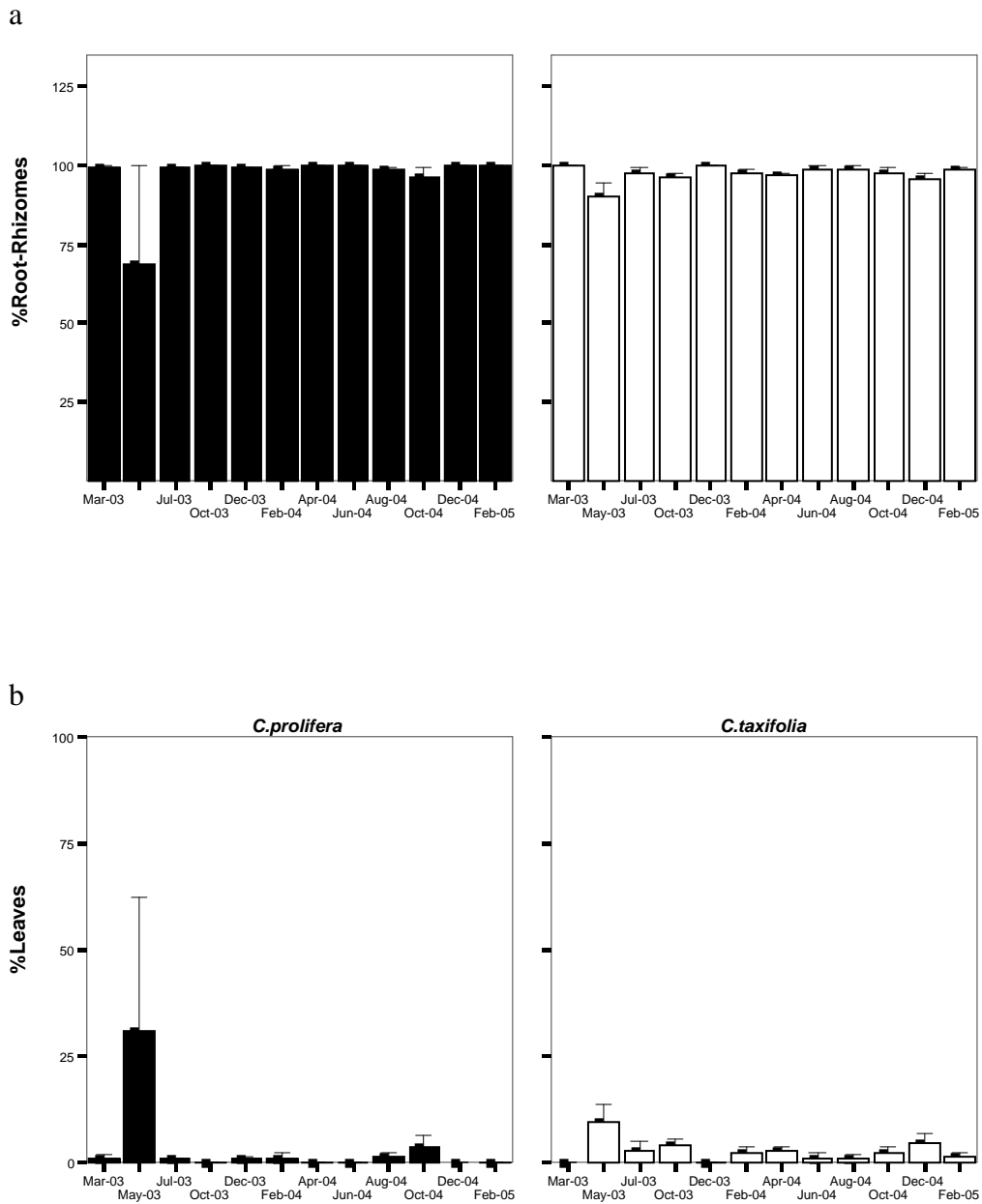

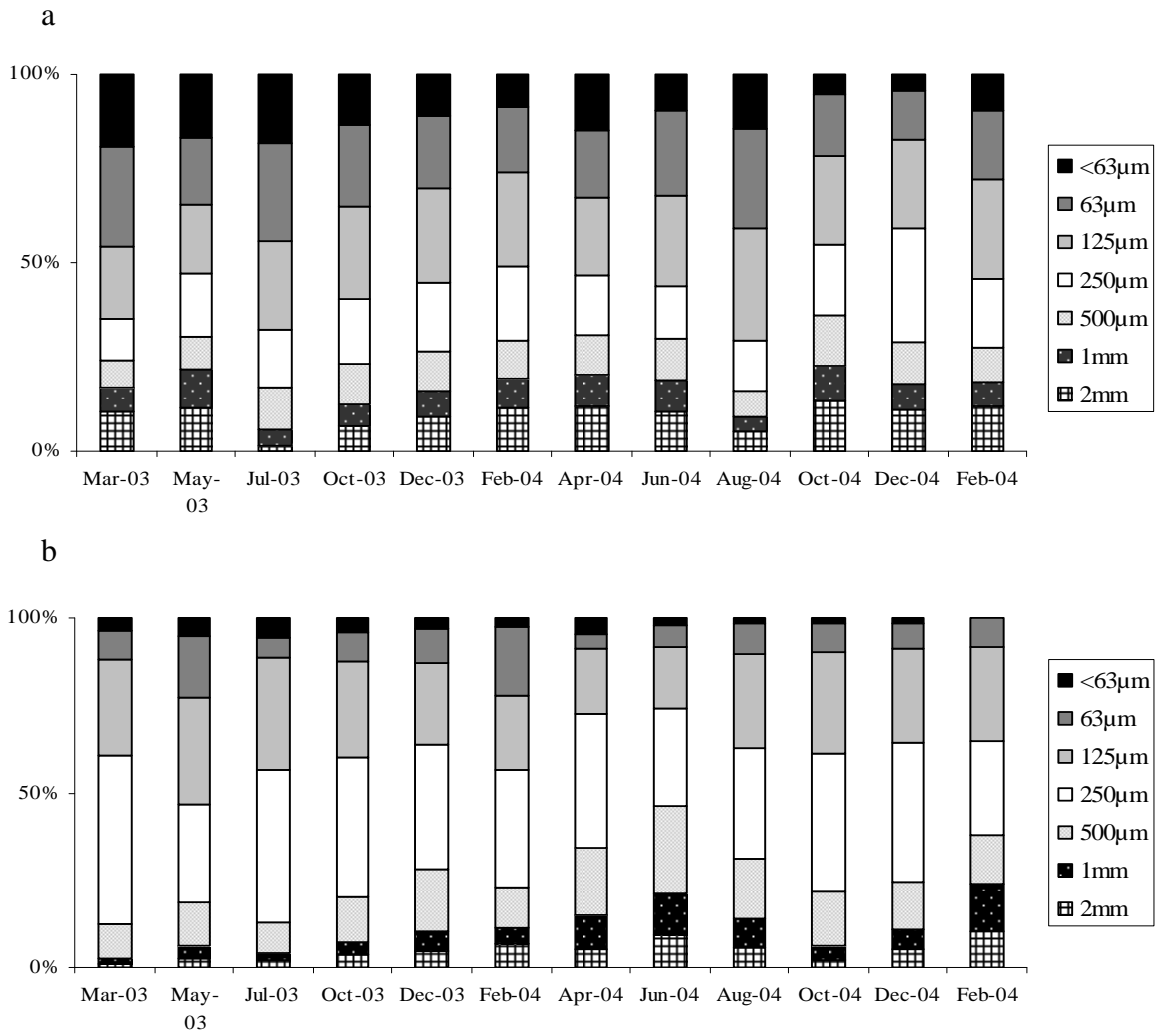

Figure 2: Seasonal variation in grain size distribution in sediments below mats formed by (a) *Caulerpa prolifera* (b) *C. taxifolia*.

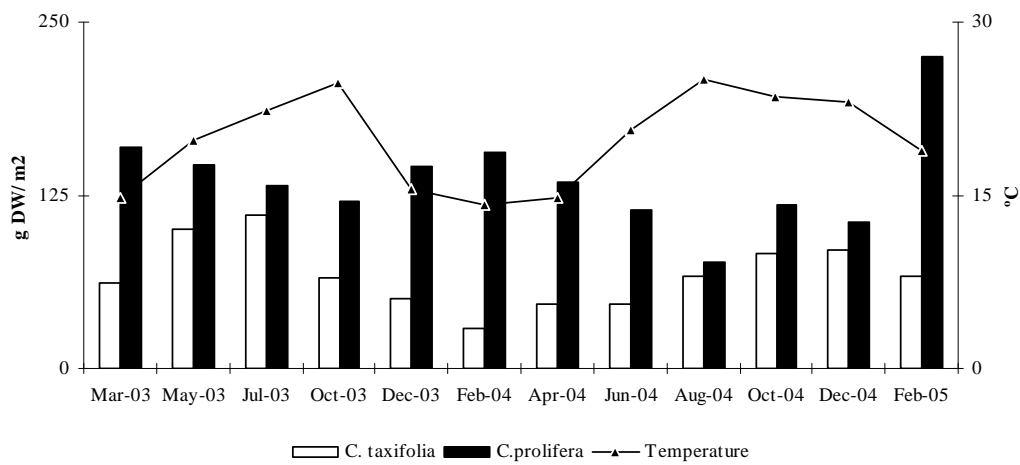

Figure 3: *Caulerpa prolifera* (black bar) and *C. taxifolia* (white bar) biomass seasonality and water temperature (continuous line) for the two-year sampling period.

***Caulerpa prolifera* meadow**

A total of 3,617 mollusc individuals/m² were collected in *Caulerpa prolifera* mats over two years. Gastropods were more abundant than bivalves and they made up 70% of total mollusc abundance. The molluscan fauna was mainly characterised by the presence of the specialised *Caulerpa* feeder *Ascobulla fragilis* (55.3% of the total abundance). Other species with abundances greater than 1% were *Cerithium vulgatum*, *Loripes lacteus*, *Glans trapezia* and *Veneropsis aurea* (Table 1).

The gastropod species *Ascobulla fragilis*, *Bittium reticulatum* and *Cerithium vulgatum* and bivalve species *Glans trapezia*, *Loripes lacteus* and *Veneropsis aurea* had a frequency of appearance higher than 25% (Table 1).

***Caulerpa taxifolia* meadow**

A total of 1,450 individuals/m² were found over two years. The dominant species in terms of abundance (higher than 1%) were the gastropod species *Ascobulla fragilis*, *Cerithium vulgatum*, *Tricolia pullus*, *Bittium reticulatum*, *Bittium latreilli* and *Rissoina bruguieri* and bivalve species *Glans trapezia*, *Ctena decussata*, *Loripes lacteus*, *Arca noae*, *Arcopagia balaustina*, *Limaria hians*, *Venus verrucosa*, *Chama gryphoides*, *Lucinella divaricata*, *Parvicardium exiguum* and *Venus casina* (Table 2).

The gastropod species *Ascobulla fragilis*, *Cerithium vulgatum* and *Tricolia pullus* and bivalve species *Glans trapezia*, *Ctena decussata*, *Loripes lacteus*, *Arca noae*, *Arcopagia balaustina* and *Limaria hians* had a frequency of appearance higher than 25% (Table 2).

Differences between meadows

The average dissimilarity of molluscan assemblages (SIMPER) between the two *Caulerpa* areas was 69.6% (Table 3). The specialised *Caulerpa* feeder, *Ascobulla fragilis* alone, contributed 13.1% to the dissimilarity between *Caulerpa* species but had higher abundances in *Caulerpa prolifera*. Overall, not considering seasonality, the observed differences between meadows were mainly due to the large differences in the mollusc abundances between meadows. For example, *A. fragilis*, *Loripes lacteus* and *Bittium reticulatum* were more abundant in *C. prolifera* while *Ctena decussata*, *Glans*

trapezia and *Cerithium vulgatum* were more abundant in *C. taxifolia* (see Table 3 for further details). The cluster representation of results does show an acceptable grouping for *C. prolifera* samples, but not for *C. taxifolia* samples (Fig. 4). The ANOSIM results showed differences between samples from both meadows (Global R = 0.443, $p < 0.01$).

Table 1. Seasonal molluscan assemblages in *Caulerpa prolifera*. Results are expressed as individuals/m². N is the total number of individuals, D represents dominance values (number of individuals of each species/total individuals) and F is the frequency of appearance (number of samples with presence of the species/total number of sampling dates).

	Mar 03	May 03	Jul 03	Oct 03	Des03	Feb 04	Apr 04	Jun 04	Aug 04	Oct 04	Des 04	Feb05	N	D	F
Gastropoda															
<i>Ascobulla fragilis</i>	17	75	58	325	67	58	175	67	8	408	300	442	2000	55,3	100,00
<i>Bittium reticulatum</i>	17	8	0	0	0	0	0	208	92	0	8	0	333	9,2	33,33
<i>Cerithium vulgatum</i>	0	8	17	0	0	0	0	0	8	17	0	0	50	1,4	33,33
<i>Columbella rustica</i>	8	0	0	17	0	0	0	0	0	0	0	0	25	0,7	16,67
<i>Nassarius cf cuvierii</i>	0	0	8	0	0	0	0	0	8	0	0	0	17	0,5	16,67
<i>Alvania cimex</i>	0	0	17	0	0	0	0	0	0	0	0	0	17	0,5	8,33
<i>Bulla striata</i>	0	0	0	0	0	0	0	0	8	0	0	0	8	0,2	8,33
Eulimidae sp.	8	0	0	0	0	0	0	0	0	0	0	0	8	0,2	8,33
<i>Gibbula ardens</i>	0	0	0	0	0	0	0	0	0	0	0	8	8	0,2	8,33
<i>Jujubinus exasperatus</i>	0	0	0	0	0	0	0	0	0	0	0	8	8	0,2	8,33
<i>Lobiger serradifalci</i>	0	0	0	0	0	8	0	0	0	0	0	0	8	0,2	8,33
<i>Oxynoe olivacea</i>	0	0	0	0	0	0	0	0	0	0	8	0	8	0,2	8,33
<i>Tricolia pullus</i>	17	0	0	0	0	0	0	0	0	0	0	0	17	0,5	8,33
<i>Tricolia speciosa</i>	0	0	0	0	8	0	0	0	0	0	0	0	8	0,2	8,33
<i>Payraudeautia intricata</i>	0	8	0	0	0	0	0	0	0	0	0	0	8	0,2	8,33
Bivalvia															
<i>Glans trapezia</i>	25	8	0	8	25	0	8	17	0	25	17	42	175	4,8	75,00
<i>Loripes lacteus</i>	42	0	17	42	25	0	8	358	8	42	142	0	683	18,9	75,00
<i>Veneropis cf aurea</i>	8	17	0	33	0	0	8	8	17	0	8	8	108	3,0	66,67
<i>Veneropis</i> juv forms	0	0	8	0	8	0	0	0	0	8	0	0	25	0,7	25,00
<i>Lucinella divaricata</i>	0	0	0	0	0	0	0	8	0	8	0	0	17	0,5	16,67
<i>Parvicardium exiguum</i>	0	0	0	0	0	8	0	0	0	0	0	8	17	0,5	16,67
<i>Arcopagia balaustina</i>	0	0	0	8	0	0	0	0	0	0	0	0	8	0,2	8,33
<i>Irus irus</i>	0	0	0	0	0	8	0	0	0	0	0	0	8	0,2	8,33
<i>Modiolus barbatus</i>	0	0	0	0	0	0	8	0	0	0	0	0	8	0,2	8,33
<i>Tapes romboides</i>	0	8	0	0	0	0	0	0	0	0	0	0	8	0,2	8,33
<i>Striarca lactea</i>	0	0	0	0	0	0	8	0	0	0	0	0	8	0,2	8,33
<i>Ruditapes decussates</i>	0	0	0	0	0	0	8	0	0	0	0	0	8	0,2	8,33
Scaphopoda sp.	0	0	0	0	0	0	0	0	17	0	0	0	17	0,5	8,33

Table 2. Seasonal molluscan assemblages in *Caulerpa taxifolia*. Results are expressed as individuals/m². N is the total number of individuals, D represents the dominance values (number of individuals of each species/total individuals) and F is the frequency of appearance (number of samples with presence of the species/total number of sampling dates).

	Mar 03	May 03	Jul 03	Oct 03	Des03	Feb 04	Apr 04	Jun 04	Aug 04	Oct 04	Des 04	Feb05	N	D	F
Gastropoda															
<i>Ascobulla fragilis</i>	0	0	0	33	8	0	8	8	0	17	0	0	75	5,17	33,33
<i>Cerithium vulgatum</i>	0	17	0	0	0	17	0	17	0	0	8	0	58	4,02	33,33
<i>Tricolia pullus</i>	0	8	8	0	0	8	0	0	0	0	0	0	25	1,72	25,00
<i>Bittium reticulatum</i>	25	0	0	0	0	0	0	0	0	0	0	8	33	2,30	16,67
<i>Bittium latreilli</i>	0	0	17	0	0	0	0	0	0	8	0	0	25	1,72	16,67
<i>Eulimidae sp.</i>	0	0	0	0	0	0	8	0	0	8	0	0	17	1,15	16,67
<i>Rissoina brugueri</i>	0	0	0	0	0	8	0	8	0	0	0	0	17	1,15	16,67
<i>Alvania cimex</i>	0	0	0	8	0	0	0	0	0	0	0	0	8	0,57	8,33
<i>Murex aluoides</i>	0	0	0	0	0	0	0	0	0	8	0	0	8	0,57	8,33
<i>Crepidula unguiformis</i>	0	8	0	0	0	0	0	0	0	0	0	0	8	0,57	8,33
<i>Gibbula ardens</i>	0	0	0	0	8	0	0	0	0	0	0	0	8	0,57	8,33
<i>Payraudeautia intricata</i>	0	0	0	0	8	0	0	0	0	0	0	0	8	0,57	8,33
<i>Pusillina philippi</i>	8	0	0	0	0	0	0	0	0	0	0	0	8	0,57	8,33
<i>Trivia arctica</i>	0	0	0	0	0	0	0	0	8	0	0	0	8	0,57	8,33
Bivalvia															
<i>Glans trapezia</i>	33	58	42	42	8	75	33	58	25	67	50	67	558	38,51	100,00
<i>Ctena decussata</i>	50	8	8	17	8	8	8	8	8	0	0	25	150	10,34	83,33
<i>Loripes lacteus</i>	33	8	17	0	0	0	25	8	0	8	0	17	117	8,05	58,33
<i>Arca noae</i>	0	0	25	8	0	0	0	8	0	0	8	0	50	3,45	33,33
<i>Arcopagia balaustina</i>	0	0	0	8	0	8	0	0	8	0	8	0	33	2,30	33,33
<i>Limaria hians</i>	0	0	0	0	0	8	0	0	17	0	8	17	50	3,45	25,00
<i>Venus verrucosa</i>	0	8	0	8	8	0	0	0	0	0	0	0	25	1,72	25,00
<i>Chama gryphoides</i>	0	0	0	8	8	0	0	0	0	0	0	0	17	1,15	16,67
<i>Lucinella divaricata</i>	0	0	8	0	0	0	0	0	0	8	0	0	17	1,15	16,67
<i>Venerupis juv forms.</i>	0	8	0	8	0	0	0	0	0	0	0	0	17	1,15	16,67
<i>Parvicardium exiguum</i>	0	0	8	0	8	0	0	0	0	0	0	0	17	1,15	16,67
<i>Venus casina</i>	8	0	0	0	0	0	0	0	0	8	0	0	17	1,15	16,67
<i>Venericardia anticuata</i>	0	0	0	8	0	0	0	0	0	0	0	0	8	0,57	8,33
<i>Gastrana fragilis</i>	0	0	0	0	0	0	0	0	8	0	0	0	8	0,57	8,33
<i>Irus irus</i>	0	0	0	0	0	0	0	0	0	8	0	0	8	0,57	8,33

<i>Dyacrydium hyalinum</i>	0	0	0	0	0	0	0	0	0	8	0	0	8	0,57	8,33
<i>Modiolus barbatus</i>	0	0	0	0	0	8	0	0	0	0	0	0	8	0,57	8,33
<i>Mysella bidentata</i>	0	0	0	0	0	0	0	0	0	0	0	8	8	0,57	8,33
<i>Tellina (Moerella) donacina</i>	8	0	0	0	0	0	0	0	0	0	0	0	8	0,57	8,33
Polyplacophora sp.	0	0	0	0	0	8	0	0	0	8	0	0	17	1,15	16,67

Table 3: Results of the SIMPER analysis for molluscan species presenting the highest dissimilarity values between the two groups of samples collected from the two habitats. AA means average abundance, AD stands for average dissimilarity between *Caulerpa prolifera* and *Caulerpa taxifolia*, AD/SD is the ratio of the average dissimilarity/ standard deviation of dissimilarity for each species. Contribution means contribution to the dissimilarity between meadows.

Species	AA	AA	AD	AD/SD	Contribution
	<i>C. prolifera</i>	<i>C. taxifolia</i>			
<i>Ascobulla fragilis</i>	166.67	6.25	9.14	1.85	13.14
<i>Loripes lacteus</i>	56.94	9.72	5.06	1.23	7.28
<i>Veneropsis aurea</i>	9.03	0.00	4.25	1.35	6.11
<i>Ctena decussata</i>	4.17	12.50	4.17	1.19	5.99
<i>Glans trapezia</i>	14.58	46.53	4.05	1.06	5.82
<i>Bittium reticulatum</i>	27.78	2.78	3.76	0.88	5.41
<i>Cerithium vulgatum</i>	4.17	4.86	3.18	0.90	4.58
<i>Limaria hians</i>	0.00	4.17	2.41	0.69	3.46
<i>Arcopagia balaustina</i>	0.69	2.78	2.27	0.73	3.26
<i>Arca noae</i>	0.00	4.17	2.41	0.69	3.22
<i>Tricolia pullus</i>	1.39	2.08	1.82	0.64	2.61
<i>Parvicardium exiguum</i>	1.39	1.39	1.80	0.60	2.59
<i>Lucinella divaricata</i>	1.39	1.39	1.59	0.61	2.29
<i>Venus verrucosa</i>	0.00	2.08	1.51	0.57	2.16
Eulimidae indet sp.	0.69	1.39	1.35	0.52	1.94
<i>Columbella rustica</i>	2.08	0.00	1.04	0.44	1.50
<i>Nassarius incrassatus</i>	1.39	0.00	1.03	0.44	1.48
<i>Alvania cimex</i>	1.39	0.69	1.03	0.42	1.48
<i>Irus iris</i>	0.69	0.69	1.00	0.41	1.43
<i>Bittium latreilli</i>	0.00	2.08	0.99	0.44	1.43
<i>Rissoina brugueri</i>	0.00	1.39	0.99	0.44	1.42
<i>Chama gryphoides</i>	0.00	1.39	0.98	0.44	1.41
<i>Payraudeautia intricata</i>	0.69	0.69	0.96	0.42	1.37
<i>Gibbula ardens</i>	0.69	0.69	0.95	0.42	1.36
<i>Venus casina</i>	0.00	1.39	0.92	0.44	1.32
<i>Modiolus barbatus</i>	0.69	0.69	0.88	0.42	1.26
<i>Oxynoe cf. olivacea</i>	0.69	0.00	0.66	0.30	0.95
<i>Tricolia speciosa</i>	0.69	0.00	0.63	0.30	0.90
Scaphopoda sp.	1.39	0.00	0.57	0.30	0.83
<i>Trivia arctica</i>	0.00	0.69	0.57	0.30	0.83

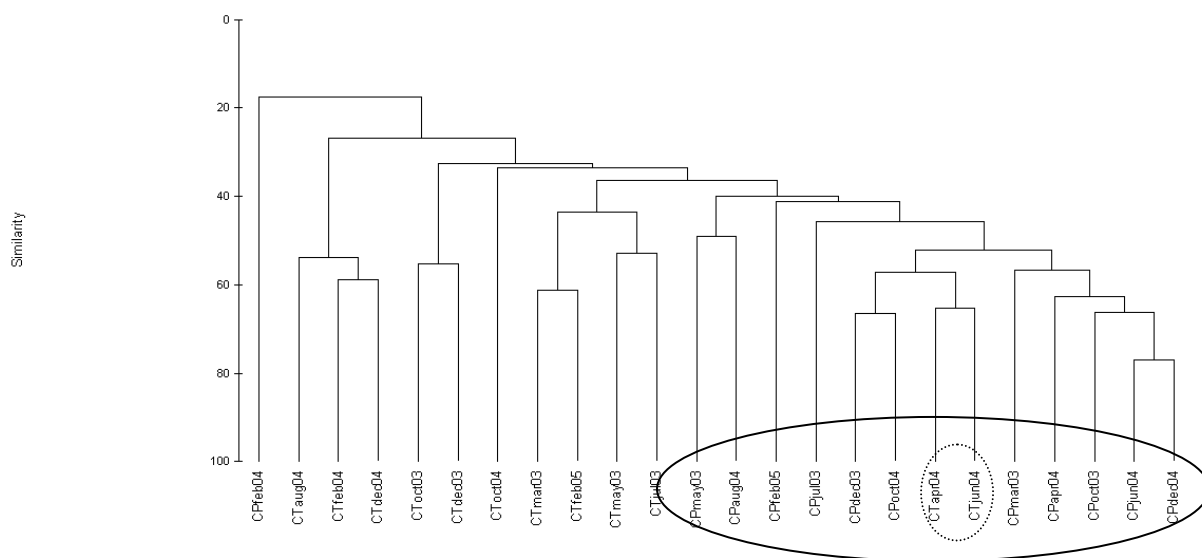

Figure 4: Cluster dendrogram representation of *C. prolifera* and *C. taxifolia* seasonal samples. CP means *C. prolifera* and CT means *C. taxifolia*. The continuous line groups all *C. prolifera* samples. The discontinuous line groups *Caulerpa taxifolia* samples that were most similar to *C. prolifera* samples.

Seasonal trends in *Caulerpa* spp.

There was no clear seasonal trend in the molluscan community descriptor variables (number of species, Shannon index and abundance/m²) between the meadows (Figs. 5a – 5c) due to inter-annual fluctuations. However, in *Caulerpa taxifolia*, the maximum number of species was during October of both years. In *C. prolifera*, the maximum number of species was found in March (2003) and in June (2004). Maximal values for the Shannon index in *C. prolifera* were found in March (2003) and August (2004) while in *C. taxifolia*, the maximal values were found in March (2003) and October (2004). The number of individuals was higher in *C. prolifera* than in *C. taxifolia* mainly due to high abundance peaks associated with *Ascobulla fragilis* (October 2003, period from October 2004 - February 2005), *Bittium reticulatum* and *Loripes lacteus* (June 2004). In *C. taxifolia*, the seasonal changes in total abundance were mainly related to the abundance of *Glans trapezia*.

Pearson correlations (Table 5) highlight the importance of *Caulerpa* biomass for molluscan fauna. *Ascobulla fragilis* was positively correlated with an increase in *Caulerpa* biomass but bivalves such as *Glans trapezia* and *Ctena decussata* were negatively affected by the increase in *Caulerpa* biomass.

The two-factor ANOVA indicated that the Shannon diversity index was significantly higher in *Caulerpa taxifolia* than in *C. prolifera*. Otherwise, the abundances of molluscs were significantly higher in *C. prolifera* than in *C. taxifolia* mainly due to the high abundance peaks of *Ascobulla fragilis*. No significant differences were found in overall species number (Table 4).

Table 4 ANOVA results for total abundance (per sample), Shannon diversity and total number of species (per sample) in *Caulerpa* spp. * $p < 0.05$, *** $p < 0.001$, ns not significant differences.

Source of variation	DF	Number of species (sample)(n=6)			DF	Shannon diversity index H' (sample)(n=6)			DF	Number individuals/m ² (sample)(n=6)		
		Mean square	F	p		Mean square	F	p		Mean square	F	p
Meadow	1	1.76	0.34	ns	1	1.84	7.49	**	1	812789.32	27.99	***
Time	11	2.81	0.54	ns	11	0.28	1.34	ns	11	91922.35	3.17	**
Meadow*Time	11	4.96	0.95	ns	11	0.27	1.11	ns	11	85188.34	2.93	**
Residual	72	5.23			72	0.25			72	29033.56		

Table 5. Pearson correlations across community descriptive indexes (S, species richness, H' Shannon index, and abundance) and *Caulerpa* species, as well as the main mollusc species contributing to the SIMPER dissimilarity values with temperature and *Caulerpa* biomass. Rho values. ** $p < 0.01$, * $p < 0.05$.

	<i>C. prolifera</i>		<i>C. taxifolia</i>		<i>C. prolifera</i> + <i>C. taxifolia</i>	
	Biomass	Temperature	Biomass	Temperature	Biomass	Temperature
S	ns	Ns	ns	ns	ns	ns
H'	ns	Ns	ns	ns	0.300**	0.244*
Individuals/m ²	ns	0.382**	ns	ns	-0.247*	ns
<i>Ascobulla fragilis</i>	0.324*	0.307*	ns	ns	0.497**	0.202*
<i>Bittium reticulatum</i>	-0.386**	Ns	ns	ns	ns	ns
<i>Ctena. decussata</i>	ns	Ns	ns	ns	-0.313**	ns
<i>Loripes lacteus</i>	ns	Ns	ns	ns	ns	ns
<i>Venerupis aurea</i>	ns	0.320*	ns	ns	0.268**	0.202*
<i>Glans trapezia</i>	0.434**	Ns	ns	ns	-0.286**	ns

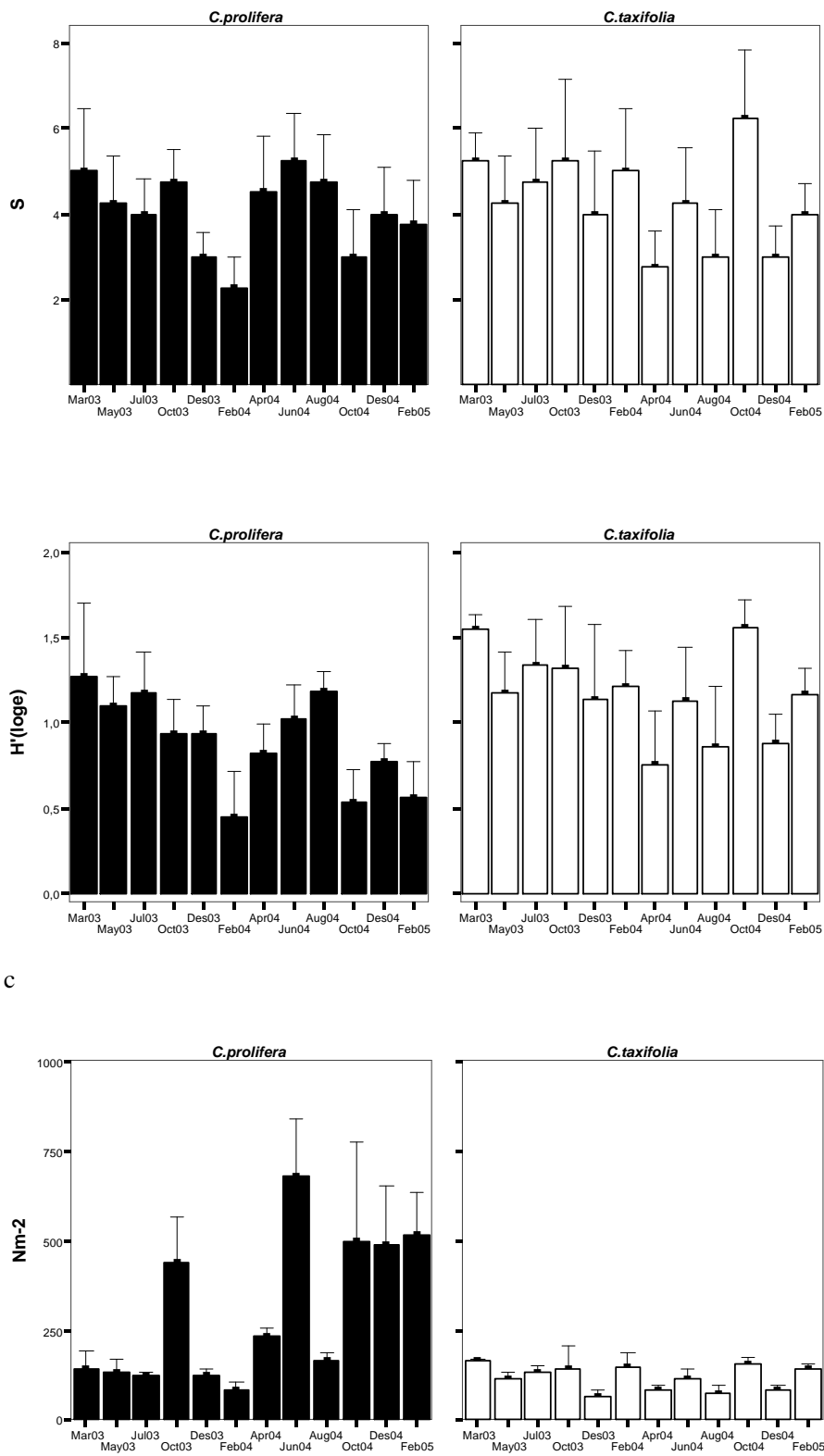

Figure 5: (a) Number of species, (b) Shannon index and (c) number of individuals/m² representing seasonal molluscan changes in *Caulerpa prolifera* and *C. taxifolia* mats.

Discussion

The present study shows that the recent invasive *Caulerpa taxifolia* supports a more diverse, but less abundant molluscan community than that in established *C. prolifera* areas. The higher molluscan abundance in *C. prolifera* is mainly due to the presence of specialist feeders of *Caulerpa*. Multivariate analysis indicates significant differences between molluscan assemblages in *Caulerpa* species mainly due to increased or decreased abundances of coincident species at both types of *Caulerpa* mats.

Previous studies on mollusc communities associated with *Caulerpa* species in the Mediterranean were mainly focused on *C. prolifera* (Murillo and Talavera 1983; Ballesteros et al. 1987; Dantart et al. 1990; Rueda et al. 2001; Sanchez-Moyano et al. 2001a; Sanchez-Moyano et al. 2001b; Rueda and Salas 2003; Sanchez-Moyano et al. 2004). There has been a lack of studies of the effects of the invasive *Caulerpa taxifolia* on the invertebrate soft-bottom communities in the Western Mediterranean. An initial study of the effects of the invasive *C. taxifolia* on the benthic community showed a decrease in the number of species (not molluscs) and abundance (BellanSantini et al. 1996); however, a recent study showed a positive effect of *C. taxifolia* on bivalve recruitment (Gribben and Wright 2006).

The habitat conditions of both *Caulerpa* species are different. Univariate analyses indicated that there were no differences in the percentage contributions of the different *P. oceanica* structures to the habitat. Grain size parameters were different between meadows with a predominance of finer grain fractions in *C. prolifera*. The seasonal changes in *Caulerpa* biomass were also different for the two species. Biomass values were always higher in both years for *C. prolifera* than for *C. taxifolia*, and consequently this had a more important effect on the molluscan community in *C. prolifera*. These differences may be partly related to the time of substrate colonisation by *Caulerpa* species; this occurred more recently for *C. taxifolia* patches.

Caulerpa prolifera is an established Mediterranean species, which is now considered to be a native Mediterranean species. Consequently, it has an associated specialised fauna, such as the *Caulerpa* feeders, *Oxynoe olivacea*, *Lobiger serradifalci* and *Ascobulla fragilis* (Thibaut and Meinesz 2000; Gianguzza et al. 2002; Trowbridge 2004; Cavas et al. 2005). *Ascobulla fragilis* was the species with higher abundance and frequency in *C. prolifera*. It was also the species identified by the SIMPER analysis as

having contributed more to the dissimilarity percentage between the two *Caulerpa* mats. Other *Caulerpa* specialists, such as *Oxynoe olivacea* and *Lobiger serradifalci*, were observed although they had very low abundances in *C. prolifera*, probably due to sampling methodology, which was more appropriate for endofaunal collection. *Ascobulla fragilis* was the only *Caulerpa* specialist feeder found in *C. taxifolia*, but it had lower abundances and frequencies than in *C. prolifera*.

Loripes lacteus, *Bittium reticulatum* and *Veneropis aurea*, with higher abundances in *C. prolifera*, were the species that contributed mostly to differences between *Caulerpa* spp. *Loripes lacteus* is a deposit feeder bivalve (Koulouri et al. 2006) and belongs to the infaunal community of *C. prolifera* mats (Sanchez-Moyano et al. 2004). *Bittium reticulatum* was present in both meadows and it is considered an ubiquitous species, which increases its densities in organic matter-enriched zones (Sanchez-Moyano et al. 2004).

Glans trapezia was the most abundant species in the *C. taxifolia* patches. Most of the individuals sampled were found over the *Posidonia oceanica* rhizomes that were covered by *C. taxifolia*. In previous studies, this bivalve was found attached to *Posidonia* rhizomes (Ballesteros et al. 1987). *Glans trapezia* was absent in faunistic studies carried out in *C. prolifera* mats elsewhere, such as S'Estany Peix (Formentera, Balearic Islands) and other localities along the Spanish Coast (Murillo and Talavera 1983; Dantart et al. 1990; Rueda et al. 2001; Sanchez-Moyano et al. 2001a; Sanchez-Moyano et al. 2001b; Rueda and Salas 2003). The results showed that *G. trapezia* grew over dead and live *P. oceanica* rhizomes, thus reflecting the importance of this substrate as an adequate habitat for this species. The individuals sampled that were attached to rhizomes were completely covered by epiphytic algae.

Both *Caulerpa* species had an important amount of coincident species such as *Ascobulla fragilis*, *Loripes lacteus*, *Ctena decussata* and *Glans trapezia*. The most important differences between the meadows were the abundances of the species. These differences were reflected in the contribution to the dissimilarity index between meadows (SIMPER analysis). Some species only appeared in one of the studied meadows, including *Veneropis aurea*, *Columbella rustica* and *Nassarius incrassatus*, which were only found in *C. prolifera*, whereas *Limaria hians*, *Arca noae* and *Venus verrucosa* were only found in *C. taxifolia*. Altogether, this means that a dominance of herbivores and deposit feeders existed in *C. prolifera* while *C. taxifolia* induces an increase in the number of filter feeders. The decrease of filter-feeding bivalves in *C.*

prolifera may be explained, at least in part, by the negative effects on bivalves of the organic matter enrichment associated with the finest grained fractions of the substrate, which was more evident during the periods of high biomass (Sanchez-Moyano et al. 2001a; Sanchez-Moyano et al. 2001b). *Caulerpa prolifera* had an important capacity for sediment retention mainly associated with its stolons and rhizoids. The higher biomass of *C. prolifera* over *C. taxifolia* in both years also means that there was a higher sediment retention by rhizoids of *C. prolifera* and consequently this may be the reason for the lowest bivalve abundances in *C. prolifera* with respect to *C. taxifolia*. The effect of *Caulerpa* biomass on the mollusc community was more evident when considering both *Caulerpa* biomasses together. Then a decrease in the number of individuals occurred when *Caulerpa* biomass increased. This negative correlation was related to the decrease in abundances of *Glans trapezia* and *Ctena decussata*, despite the increase in *Ascobulla fragilis*, thus supporting the idea that high *Caulerpa* biomass values affect bivalves negatively (Sanchez-Moyano et al. 2001a; Sanchez-Moyano et al. 2001b). This decrease in the abundances reflects a decrease of the most abundant species, such as *G. trapezia*. *Caulerpa* biomass had a positive effect on molluscan diversity. Accordingly, the habitat with the highest biomass values has increased complexity, which constitutes a barrier for fish predators (Longepierre et al. 2005).

The molluscan communities observed, with special emphasis on the endofauna, were similar to those observed in other localities in the Mediterranean (Murillo and Talavera 1983; Ballesteros et al. 1987; Dantart et al. 1990; Sanchez-Moyano et al. 2004; Templado et al. 2004; Borg et al. 2006). The use of the same sampling methodology in the same season at the same locality is very important for comparing the differences between *Caulerpa prolifera* and *C. taxifolia* under similar conditions. Consequently, this work revealed a more diverse community in the areas invaded by *C. taxifolia*, but a higher number of individuals in *C. prolifera*, mainly because it is a more established community with specialised *Caulerpa* feeders. In *C. taxifolia*, there were less *Caulerpa* feeders, but more coincident species found in the nearby *P. oceanica* meadows (Ballesteros et al. 1987; Chessa et al. 1989; Bianchi et al. 1999; Barbera-Cebrian et al. 2002; Dimech et al. 2002; Russo et al. 2002; Borg et al. 2006).

Caulerpa prolifera and *C. taxifolia* had differences in molluscan species composition, diversity and abundance. The presence of the opisthobranch *Ascobulla fragilis* confirms the occurrence of a specialised *Caulerpa* feeder in both meadows, but the higher biomass of *C. prolifera* and its long-term coexistence with *A. fragilis* resulted

in the highest abundance being found in *C. prolifera*. In *C. prolifera*, molluscs were mainly characterised by herbivores and detritivores, while *C. taxifolia* appeared to be a more suitable habitat for filter-feeders. The results obtained provide a baseline for further studies to examine other factors that may explain the molluscan community associated with the invasive *Caulerpa taxifolia*. These may include the presence of toxic metabolites, which are lower in *C. taxifolia* (Sureda et al. 2006), and the herbivory of non-specialised molluscan feeders on *Caulerpa* (Sureda et al. 2007; Sureda et al. 2008).

Acknowledgements

This research was funded by the Science and Technology Ministry (Plan Nacional I+D, REN 2002-0001/MAR). The first author was funded by postgraduate research grant I3P FSE. We are most grateful to P. Sarriera, A. Sureda, A. Frau, C. Alonso, J. Terrados and N. Marba for their help with sample collection.

References

- Balata, D., L. Piazzì and F. Cinelli. - 2004. A comparison among assemblages in areas invaded by *Caulerpa taxifolia* and *C. racemosa* on a subtidal Mediterranean rocky bottom. *PSZN I: Mar. Ecol.* 25: 1-13.
- Ballesteros, M., J. Castelló, M. Gallés and R. Sarda. - 1987. *Invertebrados algúícolas marinos de las islas pitiusas*. Consell Insular d'Eivissa i Formentera 93pp.
- Barbera-Cebrian, C., P. Sanchez-Jerez and A.A. Ramos-Espla. - 2002. Fragmented seagrass habitats on the Mediterranean coast, and distribution and abundance of mysid assemblages. *Mar. Biol.* 141: 405-413.
- Bax, N., A. Williamson, M. Agüero, E. Gonzalez and W. Geves. - 2003. Marine invasive alien species: a threat to global biodiversity. *Mar. Policy.* 27: 313-323.
- BellanSantini, D., P.M. Arnaud, G. Bellan and M. Verlaque. - 1996. The influence of the introduced tropical alga *Caulerpa taxifolia*, on the biodiversity of the Mediterranean marine biota. *J. Mar. Biol. Assoc. UK.* 76: 235-237.

- Bianchi, T.S., M. Argyrou and H.F. Chippett. - 1999. Contribution of vascular-plant carbon to surface sediments across the coastal margin of Cyprus (eastern Mediterranean). *Org. Geochem.* 30: 287-297.
- Borg, J.A., A.A. Rowden, M.J. Attrill, P.J. Schembri and M.B. Jones. - 2006. Wanted dead or alive: high diversity of macroinvertebrates associated with living and 'dead' *Posidonia oceanica* matte. *Mar. Biol.* 149: 667-677.
- Boudouresque, C.F. and M. Verlaque. - 2002. Biological pollution in the Mediterranean Sea: invasive versus introduced macrophytes. *Mar. Pollut. Bull.* 44: 32-38.
- Cavas, L., K. Yurdakoc and B. Yokes. - 2005. Antioxidant status of *Lobiger serradifalci* and *Oxynoe olivacea* (Opisthobranchia, Mollusca). *J. Exp. Mar. Biol. Ecol.* 314: 227-235.
- Chessa, L.A., G. Bionda, M.C. Buia, C. Gambi, M. Lorenti, R. Maj, R. Manconi, M. Martinelli, M.G. Pintus, G.F. Russo, M.B. Scipione and E. Taramelli. - 1989. Indagini su *Posidonia oceanica* nella rada di Porto Conte (Sadezna Nord-Occidentale): Caratteristiche della prateria e fauna vagile. *Oebalia.* XV: 99-107.
- Dantart, M., M. Frechilla and M. Ballesteros. - 1990. Fauna malacologica del Estany des Peix (Formentera). *IBERUS.* 9: 111-125.
- Devillele, X. and M. Verlaque. - 1995. Changes and Degradation in a *Posidonia oceanica* Bed Invaded by the Introduced Tropical Alga *Caulerpa taxifolia* in the North-Western Mediterranean. *Bot. mar.* 38: 79-87.
- Dimech, M., J.A. Borg and P.J. Schembri. - 2002. Changes in the structure of a *Posidonia oceanica* meadow and in the diversity of associated decapod, mollusc and echinoderm assemblages, resulting from inputs of waste from a marine fish farm (Malta, Central Mediterranean). *Bull. Mar. Sci.* 71: 1309-1321.
- Dumay, O., G. Pergent, C. Pergent-Martini and P. Amade. - 2002. Variations in caulerpenyne contents in *Caulerpa taxifolia* and *Caulerpa racemosa*. *J. Chem. Ecol.* 28: 343-352.
- Gianguzza, P., L. Airoidi, R. Chemello, C.D. Todd and S. Riggio. - 2002. Feeding preferences of *Oxynoe olivacea* (Opisthobranchia : Sacoglossa) among three *Caulerpa* species. *J. Molluscan Stud.* 68: 289-290.

- Gribben, P.E. and J.T. Wright. - 2006. Invasive seaweed enhances recruitment of a native bivalve: roles of refuge from predation and the habitat choice of recruits. *Mar. Ecol. Prog. Ser.* 318: 177-185.
- Koulouri, P., C. Dounas, C. Arvanitidis, D. Koutsoubas and A. Eleftheriou. - 2006. Molluscan diversity along a Mediterranean soft bottom sublittoral ecotone. *Sci. Mar.* 70: 573-583.
- Longepierre, S., A. Robert, F. Levi and P. Francour. - 2005. How an invasive alga species (*Caulerpa taxifolia*) induces changes in foraging strategies of the benthivorous fish *Mullus surmuletus* in coastal Mediterranean ecosystems. *Biodiversity Conserv.* 14: 365-376.
- MacDougall, A.S. and R. Turkington. - 2005. Are invasive species the drivers or passengers of change in degraded ecosystems? *Ecology.* 86: 42-55.
- Mack, R.N., D. Simberloff, W.M. Lonsdale, H. Evans, M. Clout and F.A. Bazzaz. - 2000. Biotic invasions: Causes, epidemiology, global consequences, and control. *Ecol. Appl.*, 10: 689-710.
- Meinesz, A. - 2004. *Caulerpa taxifolia* continues its invasion. *Biofutur*: 41-46.
- Meinesz, A., T. Belsher, T. Thibaut, B. Antolic, K.B. Mustapha, C.F. Boudouresque, D. Chiaverini, F. Cinelli, J.M. Cottalorda, A.S. Djellouli, A. El Abed, C. Orestano, A.M. Grau, L. Ivesa, I. Vaugelas, N. Zavodnik and A. Zuljevic. - 2001. The introduced green alga *Caulerpa taxifolia* continues to spread in Mediterranean. *Biol. Inv.* 3: 201-210.
- Meinesz, A., J. Devaugelas, B. Hesse and X. Mari. - 1993. Spread of the Introduced Tropical Green-Alga *Caulerpa taxifolia* in Northern Mediterranean Waters. *J. Appl. Phycol.* 5: 141-147.
- Meinesz, A. and B. Hesse. - 1991. Introduction of the Tropical Alga *Caulerpa taxifolia* and Its Invasion of the Northwestern Mediterranean. *Oceanol. Acta.* 14: 415-426.
- Murillo, M. and P.A. Talavera. - 1983. Aportación a la malacología de una laguna litoral: El Mar Menor (Murcia). *IBERUS.* 3: 15-28.
- Occhipinti-Ambrogi, A. and D. Savini. - 2003. Biological Invasions as a component of global change in stressed marine ecosystems. *Mar. Pollut. Bull.* 46: 542-551.

- Phillips, J.A. and I.R. Price. - 2002. How different is Mediterranean *Caulerpa taxifolia* (Caulerpales : Chlorophyta) to other populations of the species? *Mar. Ecol. Prog. Ser.* 238: 61-71.
- Pou, S., E. Ballesteros, O. Delgado, A.M. Grau, F. Riera and B. Weitzmann. - 1993. Sobre la presencia del alga *Caulerpa taxifolia* (Vahl) C. Agardh (Caulerpales, Chlorophyta) en aguas costeras de Mallorca. *Boll. Soc. Hist. Nat. Illes Balears.* 36: 83-90.
- Rueda, J.L., M. Fernandez-Casado, C. Salas and S. Gofas. - 2001. Seasonality in a taxocoenosis of molluscs from soft bottoms in the Bay of Cadiz (southern Spain). *J. Mar Biol. Assoc. UK.* 81: 903-912.
- Rueda, J.L. and C. Salas. - 2003. Seasonal variation of a molluscan assemblage living in a *Caulerpa prolifera* meadow within the inner Bay of Cadiz (SW Spain). *Est. Coast. Shelf Sci.* 57: 909-918.
- Russo, G.F., S. Fraschetti and A. Terlizzi. - 2002. Population ecology and production of *Bittium latreillii* (Gastropoda, Cerithidae) in a *Posidonia oceanica* seagrass bed. *Ital. J. Zool.* 69: 215-222.
- Sakai, A.K., F.W. Allendorf, J.S. Holt, D.M. Lodge, J. Molofsky, K.A. With, S. Baughman, R.J. Cabin, J.E. Cohen, N.C. Ellstrand, D.E. McCauley, P. O'Neil, I.M. Parker, J.N. Thompson and S.G. Weller. - 2001. The population biology of invasive species. *Annu. Rev. Ecol. Syst.* 32: 305-332.
- Sanchez-Moyano, J.E., F.J. Estacio, E.M. Garcia-Adiego and J.C. Garcia-Gomez. - 2001a. Effect of the vegetative cycle of *Caulerpa prolifera* on the spatio-temporal variation of invertebrate macrofauna. *Aquat. Bot.* 70: 163-174.
- Sanchez-Moyano, J.E., E.M. Garcia-Adiego, F.J. Estacio and J.C. Garcia-Gomez. - 2001b. Influence of the density of *Caulerpa prolifera* (Chlorophyta) on the composition of the macrofauna in a meadow in Algeciras Bay (southern Spain). *Cienc. Mar.*, 27: 47-71.
- Sanchez-Moyano, J.E., D. Moreno, J.L. Rueda, J.E. Garcia-Raso, C. Salas and S. Gofas. - 2004. Las praderas de *Caulerpa prolifera*. In: C.d.M. Ambiente (ed.), *Praderas y bosques marinos de Andalucía*, pp. 239-249. Junta de Andalucía, Sevilla.

- Sureda, A., A. Box, S. Deudero and A. Pons. - 2007. Protective response of *Caulerpa taxifolia* under intense herbivore pressure. In: CIESM (ed.), *Rapp. Comm. int. Mer Médit*, Istanbul. 38: 608.
- Sureda, A., A. Box, S. Deudero and A. Pons. - 2008. Reciprocal effects of caulerpenyne and intense herbivorism on the antioxidant response of *Bittium reticulatum* and *Caulerpa taxifolia*. *Ecotoxicol. Environ. Safety*. in press: doi:10.1016/j.ecoenv.2007.12.007.
- Sureda, A., A. Box, M. Ensenat, E. Alou, P. Tauler, S. Deudero and A. Pons. - 2006. Enzymatic antioxidant response of a labrid fish (*Coris julis*) liver to environmental caulerpenyne. *Comp. Biochem. Physiol.* 144C: 191-196.
- Templado, J., E. Ballesteros, J.E. Garcia-Raso, G.A. San Martin, L. Lopez-Garcia, C. Salas, A. Luque, J.L. Sanchez-Lizaso and D. Moreno. - 2004. La comunidad posidonícola. In: A.A. Luque del Villar and J. Templado (eds.), *Praderas y Bosques Marinos de Andalucía*. Consejería de Medio Ambiente, Junta de Andalucía, Sevilla.
- Thibaut, T. and A. Meinesz. - 2000. Are the Mediterranean ascoglossan molluscs *Oxynoe olivacea* and *Lobiger serradifiii* suitable agents for a biological control against the invading tropical alga *Caulerpa taxifolia*? *Comptes Rendus De L Academie Des Sciences Serie Iii-Sciences De La Vie-Life Sciences*. 323: 477-488.
- Trowbridge, C.D. - 2004. Emerging associations on marine rocky shores: specialist herbivores on introduced macroalgae. *J. Anim.l Ecol.* 73: 294-308.
- Verlaque, M., J. Afonso-Carrillo, M.C. Gil-Rodriguez, C. Durand, C.F. Boudouresque and Y. Le Parco. - 2004. Blitzkrieg in a marine invasion: *Caulerpa racemosa* var. *cylindracea* (Bryopsidales, Chlorophyta) reaches the Canary Islands (north-east Atlantic). *Biol. Inv.* 6: 269-281.

2.4 Resumen de las comunidades de moluscos

Resumen del estudio “A mollusc community associated with invasive *Caulerpa racemosa* in the Western Mediterranean shallow seagrass beds”

- Las especies dominantes de moluscos en *Caulerpa racemosa* var. *cylindracea* son los gasterópodos *Bittium reticulatum*, *Alvania cimex*, *Ascobulla fragilis*, *Nassarius incrassatus*, *Smaragdia viridis*, *Rissoina bruguieri*, *Cerithium vulgatum* y *Gibbula ardens* y los bivalvos *Glans trapezia*, *Ctena decussata*, *Loripes lacteus*, *Limaria hians*, *Venerupis aurea*, *Venus verrucosa* y *Musculus costulatus*.
- *Caulerpa racemosa* var. *cylindracea* y *Posidonia oceanica* comparten un gran número de especies de moluscos con distintas densidades. Este es el caso de las especies *Glans trapezia*, *Bittium reticulatum*, *Loripes lacteus* y *Smaragdia viridis*, presentes en ambos hábitats, pero con mayores abundancias en *C. racemosa* var. *cylindracea*. También contribuye de forma importante a la diferenciación entre ambas praderas el bivalvo *Ctena decussata*, sólo presente en *C. racemosa* var. *cylindracea*.
- La abundancia acumulada de moluscos a lo largo de los doce muestreos temporales realizados en la pradera de *Caulerpa racemosa* var. *cylindracea* es de 1925 individuos correspondientes a 37 especies. En *Posidonia oceanica* la abundancia de moluscos es inferior, con un total de 492 individuos pertenecientes a 23 especies.
- El número de especies de moluscos, su diversidad y su abundancia presentan patrones estacionales en *Caulerpa racemosa* var. *cylindracea* con diferencias significativas respecto a *Posidonia oceanica*.
- La mayor diversidad de moluscos en *Caulerpa racemosa* var. *cylindracea* se encontró en octubre (5 especies de gasterópodos y 7 especies de bivalvos) y la menor en febrero 2003 (3 especies de gasterópodos). La abundancia máxima de moluscos en *C. racemosa* var. *cylindracea* se encontró en febrero del 2005 asociada a los picos de presencia de *Bittium reticulatum* (92 ind. / m²) y *Glans trapezia* (100

ind. / m²). La abundancias y diversidad de especies no presentan una coincidencia temporal..

- El ciclo anual de biomasa de *Caulerpa racemosa* var. *cylindracea* no muestra correlación con la abundancia y diversidad de moluscos. No obstante, los muestreos correspondientes a periodos con cobertura del sustrato de *Caulerpa racemosa*, muestran mayor diversidad de especies de moluscos que la pradera de *Posidonia oceanica*. La cobertura del sustrato por macroalgas promueve la generación de un hábitat que permite el incremento de la diversidad de especies de moluscos, tal y como muestran los resultados, coincidiendo con estudios similares (Gambi et al. 1998; Arrivillaga and Baltz 1999; Sanchez-Jerez et al. 1999b).

Resumen del estudio “How different is the mollusc community between invasive *Caulerpa taxifolia* (Chlorophyta: Caulerpaceae) and established *C. prolifera* in shallow seagrass beds of the Western Mediterranean?”

- El principal resultado es la presencia de una mayor diversidad de moluscos en la macroalga invasora *Caulerpa taxifolia* (35 especies) respecto *C. prolifera* (27 especies). Por el contrario, la abundancia acumulada de moluscos a lo largo de los dos años, es superior en *C. prolifera*, con 3617 moluscos, respecto a *C. taxifolia*, con 1450 ejemplares, principalmente debido a la elevada abundancia del opistobranquio *Ascobulla fragilis*, consumidor directo de *Caulerpa*.
- En *Caulerpa prolifera* son más abundantes los gasterópodos (70 % de la abundancia total de los moluscos) que los bivalvos (29 %). La abundancia de *Ascobulla fragilis* supone un 55.3% del total de moluscos. Las especies *Cerithium vulgatum*, *Bittium reticulatum*, *Loripes lacteus*, *Glans trapezia* y *Venerupis aurea* junto con *A. fragilis* son las especies dominantes.
- En *Caulerpa taxifolia* las especies dominantes son los gasterópodos *Ascobulla fragilis*, *Cerithium vulgatum*, *Tricolia pullus*, *Bittium reticulatum*, *Bittium latreilli*, *Rissoina bruguieri* y los bivalvos *Glans trapezia*, *Ctena decussata*, *Loripes lacteus*,

Arca noae, *Arcopagia balaustina*, *Limaria hians*, *Venus verrucosa*, *Chama gryphoides*, *Lucinella divaricata*, *Parvicardium exiguum* y *Venus casina*.

- *Caulerpa taxifolia* y *C. prolifera* presentan una elevada coincidencia a nivel de especies, pero con diferencias en las densidades relativas. Las especies responsables de la diferenciación entre ambos hábitats son *Ascobulla fragilis*, *Loripes lacteus* y *Bittium reticulatum*, con mayor abundancia en *C. prolifera*, y *Glans trapezia* y *Ctena decussata*, con mayor abundancia en *C. taxifolia*. La especie *Venerupis aurea*, dentro de las especies que más contribuye a las diferencias, ha sido muestreada únicamente en *C. prolifera*.
- El análisis de las estrategias tróficas muestra un dominio de organismos herbívoros como *Ascobulla fragilis* y detritívoros como *Loripes lacteus* en hábitats de *Caulerpa prolifera*; mientras que en *C. taxifolia* son favorecidos los moluscos filtradores tales como *Glans trapezia*. Parece ser que *C. taxifolia* no presenta efectos deletéreos sobre organismos filtradores, como ha sido previamente descrito por Gribben *et al* (2006) para la especie *Anadara trapezia*.
- El incremento de biomasa en *Caulerpa prolifera* tiene un efecto positivo sobre el consumidor directo *Ascobulla fragilis*, reflejado como un aumento de su abundancia. Elevadas biomásas de *Caulerpa* spp. implican una reducción de la abundancia de organismos filtradores como *Glans trapezia* o *Ctena decussata*. Este resultado es similar al encontrado en moluscos en la bahía de Algeciras para *C. prolifera* (Sánchez-Moyano *et al.* 2001b)

Capítulo 3

CAMBIOS EN LAS COMUNIDADES DE DECÁPODOS CHANGES IN DECAPODA COMMUNITIES

Capítulo adaptado de:

Changes in decapod crustacea faunistic composition associated with the seagrass *Posidonia oceanica* (Delile) induced by the presence of invasive *Caulerpa* species.
Box, A., Deudero, S., Abellò, P. 2008. **In prep.**

3.1 Introducción al capítulo.

En el presente capítulo se analizan las variaciones en abundancia, diversidad y estacionalidad de decápodos encontrados en praderas de *Posidonia oceanica*, *Caulerpa prolifera*, *C. taxifolia* y *C. racemosa* var *cylindracea*.

Los decápodos pertenecen al filum de los crustáceos, junto a otros órdenes como los anfípodos, anisópodos o isópodos. Comprenden gran cantidad de especies de gran movilidad como las pequeñas gambas de los géneros *Hyppolyte* y *Palaemon* (principalmente asociados al estrato folial de *P. oceanica*). La fauna móvil de las fanerógamas marinas constituye un grupo de organismos bien estudiado, especialmente aquella asociada al estrato folial de *Posidonia oceanica* (Templado 1984; Ergen et al. 1988; Gambi et al. 1992). El estrato rizomático ha sido muy poco estudiado, principalmente por la dificultad de trabajo con las muestras. Dentro de los pocos trabajos referidos al rizoma, debemos destacar los trabajos referentes a decápodos realizados por Garcia-Raso (Garcia-Raso 1990; Garcia-Raso et al. 1996).

Este trabajo se ha realizado a lo largo del período comprendido entre febrero 2003 y febrero 2005. Se han recogido muestras de bentos cada dos meses, en áreas pobladas por *Posidonia oceanica*, *Caulerpa prolifera*, *C. taxifolia* y *C. racemosa* var *cylindracea*. Se han estudiado los organismos recogidos en el volumen correspondiente a un cuadrante 20 * 20 cm, insertado 5 cm en el sustrato blando.

La abundancia y diversidad de especies de decápodos han sido analizadas con el fin de establecer la similitud o disimilitud entre los cuatro hábitats y cuales son las especies responsables de las diferencias entre ellos.

Para completar el presente estudio, se ha valorado la importancia de los parámetros estructurales del hábitat (biomasa de las caulerpales, biomasa de los diferentes componentes de *Posidonia oceanica* y las características granulométricas del sedimento) como variables que pueden afectar la abundancia tanto de especies concretas como de los descriptores de la comunidad de decápodos.

Para la correcta identificación de las especies de decápodos en el presente capítulo, se han utilizado como obras de referencias, los trabajos taxonómicos “Crustáceos Decápodos Ibéricos” (Zariquiey 1968), “Hermit Crabs of the Northeastern Atlantic Ocean and the Mediterranean Sea” (Ingle 1993), “European and Mediterranean Thalassinidea (Crustacea, Decapoda)” (Ngoc-ho 2003), “Cle préliminaire

d'identification des Crustácea Decapoda de France” (Noel 1992), “Campagnes du “Professeur Lacaze-Duthiers” aux Baléares: Juin 1953 et Aout 1954 Crustacés Décapodes” (Forest 1965), “Inventaire et distribution des crustacés décapodes del’Atlantique nord-oriental, de loa Mediterranée et des eaux continentales adyacentes au nord de 25° N” (d'UdeKem d'Acoz 1999), entre otras publicaciones científicas, y la dirección de internet de “Crustikon” <http://www.imv.uit.no/crustikon/>. La correcta nomenclatura de las especies ha sido verificada en “ERMS, The European Register of Marine Species”, <http://www.marbef.org/data/erms.php>.

3.2 Changes in decapod crustacean faunistic composition associated with the seagrass *Posidonia oceanica* (Delile) induced by the presence of invasive *Caulerpa* species.

Abstract

The regression of the *Posidonia oceanica* seagrass meadows, associated to the colonisation of the basal stratum by invasive macroalgae of the genus *Caulerpa*, induces important alterations in the ecosystem functioning such as changes in the benthic faunal communities. To evaluate the differences in the *P. oceanica* seagrass and *Caulerpa* mats decapoda communities a two-year study was carried out in the Balearic Islands (Western Mediterranean). The present study shows that the occurrence of invasive *Caulerpa* macroalgae increase the number of decapoda species, densities and seasonality (*C. taxifolia* and *C. racemosa* mats presenting a total of 11 species in late summer) compared to the non-invaded *P. oceanica* seagrass meadows (with a maximum of 6 species found in spring). Shannon- Wiener diversity index showed significant differences among meadows with maximum values in *C. prolifera* in June 2004 (H=1.77), *C. racemosa* April 2004 (H=2.03), *C. taxifolia* (H= 2.06) and *P. oceanica* in April 04 (H= 1.79). For some species, such as *Athanas nitescens* in *Caulerpa* mats and *P. oceanica* meadows, different abiotical parameters were correlated with the decapoda specie abundances. Multivariate analysis showed significant differences among invaded and non-invaded meadows in decapoda species abundances, diversity and seasonality (ANOVA, $p < 0.05$). Multidimensional scaling showed a clear differentiation of the *P. oceanica* meadow decapoda assemblage from that of *Caulerpa* mats. The results demonstrate that *Caulerpa taxifolia* and *Caulerpa racemosa* generate a suitable habitat for decapoda infaunal species changing the general patterns in the Mediterranean seagrass ecosystem dynamics.

Key words: alien species, *Caulerpa racemosa*, *Caulerpa taxifolia*, seagrass, Decapoda, infauna, benthos, western Mediterranean.

Introduction

Seagrass beds are key ecosystems around the world (Hillman et al. 1995) and in the Mediterranean, *Posidonia oceanica* (L.) Delile is the dominant species in infralittoral waters, with an estimated extension ranging from 2.5 to 5.5 million hectares (Buia et al. 2000). Seagrass beds are characterized by a foliar canopy and a root-rhizome layer that considerably influence the associated fauna (Buia et al. 2000; Borg et al. 2006). The dead of the seagrass mats also constitutes a new habitat which supports a rich macrofauna in terms of species number and diversity (Borg et al. 2006).

In recent years, invasive species have become a serious problem around the world, representing a serious threat to natural ecosystems (Mack et al. 2000) and constituting a major driver of biodiversity loss (Sakai et al. 2001). This problem is present in the Mediterranean Sea where at least 84 introduced macrophytes have been reported (Boudouresque and Verlaque 2002). The spread of alien species changes the ecosystem dynamics and affects the invertebrate communities. In the Mediterranean, three species of the genus *Caulerpa* are found: *Caulerpa taxifolia* (Vahl) C. Agardh (non-native species), *Caulerpa racemosa* (Forsk.) (non-native species) and *Caulerpa prolifera* (native species). The occurrence of the alien species changes the faunistic composition and species abundances, becoming an incipient problem (Pandolfo and Chemello 1995; BellanSantini et al. 1996; Argyrou et al. 1999; Buia et al. 2001). *Caulerpa prolifera* (Forsk.) is a subtropical species with the growth-reproductive cycle linked to water temperature (Meinesz 1979). It occurs throughout the Mediterranean and is considered an autochthonous species (Sanchez-Moyano et al. 2004). *Caulerpa prolifera* (Forsk.) is common in areas with high organic matter content and sheltered bays with low flow and little water renewal (Sanchez-Moyano et al. 2001a).

Caulerpa racemosa is spreading throughout the Mediterranean basin and it has been reported along the coastline of 10 Mediterranean countries: Albania, Croatia, France, Greece, Italy, Libya, Malta, Spain, Tunisia and Turkey (Verlaque et al. 2003). This species spreads on all types of substrate, in both sheltered and exposed areas, and shows a wide depth distribution ranging from 0 to 70 m (Argyrou et al. 1999; Piazzini and Cinelli 1999; Zuljevic et al. 2003). The first report of *C. racemosa* in the Balearic Islands took place in Palma Bay in 1998 (Ballesteros et al. 1999) and nowadays is common around Mallorca Island. The other invasive *Caulerpa*, *C. taxifolia*, was

introduced in 1984 in Monaco and in a few years this algae has expanded throughout the western Mediterranean occupying 3000 ha in 1997 (Meinesz 1997). *C. taxifolia* spreads over all types of substrate including rocks, sand, mud (Meinesz and Hesse 1991) and dead *Posidonia oceanica* rhizomes. The first report of *C. taxifolia* in Mallorca was in 1992 in Cala d'Or Bay and, nowadays, it continues restricting its presence to this bay.

The vagile fauna associated to Mediterranean seagrasses represents a relatively well-studied group of organisms, specially those occurring in *P. oceanica* beds (Templado 1984; Ergen et al. 1988; Gambi et al. 1992). Most studies are focused on foliar communities, whereas the rhizome compartment has been less studied (García-Raso 1990; García-Raso et al. 1996). The death of *P. oceanica* mats and the posterior colonisation of the substrate by *Caulerpa* species is an ecological problem that alters the invertebrate community. The main objective of this work is to detect changes in the decapoda species composition and diversity inhabiting *Posidonia oceanica* seagrass beds caused by the colonisation of algae of the genus *Caulerpa*.

Material and methods

Study areas

The study was carried out in Mallorca (Balearic Islands, Western Mediterranean). Sampling stations were selected within a similar bathymetry (5-8 m) and hydrodynamic regimes (enclosed bays). The sampled substrates were (1) *P. oceanica* seagrass meadow (without *Caulerpa*); (2) *P. oceanica* colonised by *Caulerpa prolifera* mats; (3) *P. oceanica* colonised by *Caulerpa taxifolia*; and (4) *P. oceanica* colonised by *Caulerpa racemosa*. Substrate (1), (2), and (3) were sampled at Cala d'Or Bay, on the east coast of Mallorca; category (4) was sampled at Portals Vells, on the west (facing south) coast of the island (Fig. 1).

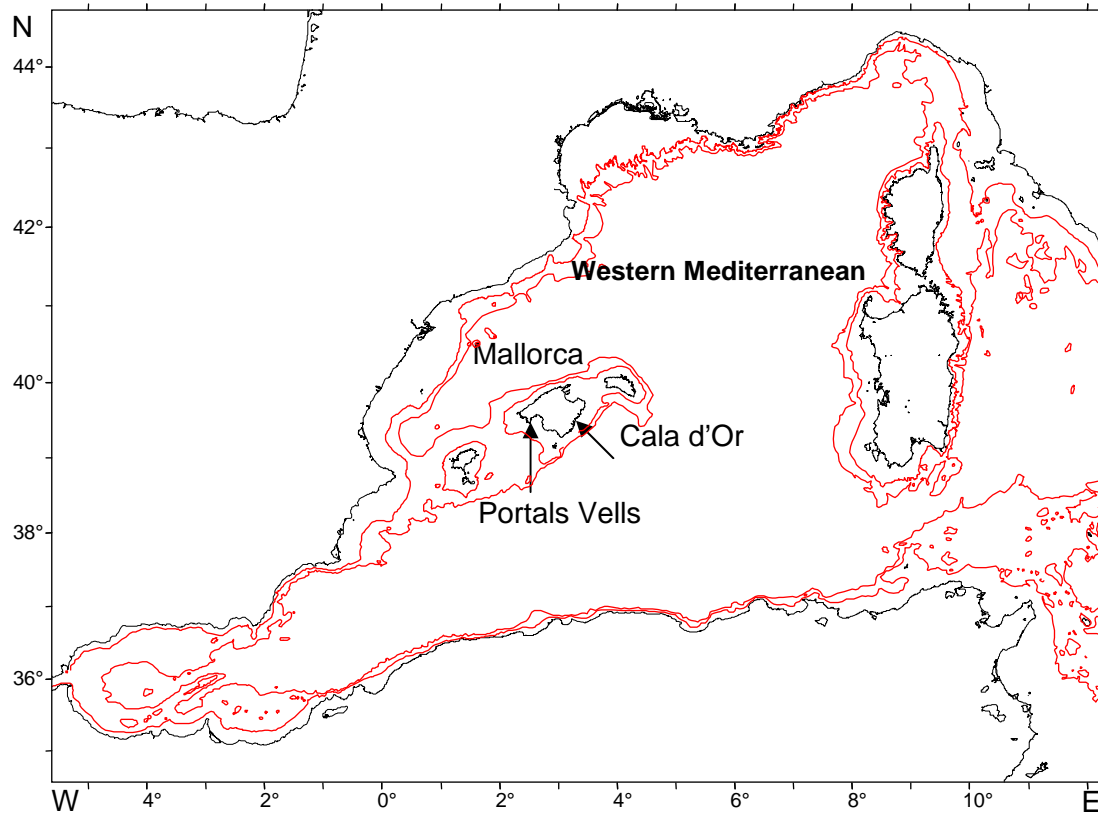

Figure 1: Map of the sampling locations. At Cala d'Or Bay *Posidonia oceanica*, *Caulerpa prolifera* and *C. taxifolia* were sampled. At Portals Vells, *C. racemosa* was collected.

Sampling methods

The macrobenthic fauna associated to *Caulerpa* mats, including the infaunal decapod crustaceans, was sampled bimonthly from February 2003 to February 2005, with the exception of the samples taken between July 2003 and October 2003, in which a three-month lapse occurred due to logistical and weather conditions. Three replicate samples (for each meadow and sampling date) of a 20 x 20 cm frame were inserted 5 cm deep into the sediment, providing a total sampling area of 2000 cm³. The frames were sampled by SCUBA diving in the morning (10-12 h GMT). Samples were placed in a bag of 0.5 mm mesh plastic bag and sorted out in the laboratory. Rhizomes, roots, sheaths and leaves of *P. oceanica* were sorted out and after drying during 24 h at 60°C their biomass was quantified as dry weight (DW). The different *P. oceanica* fractions were expressed as percentage of the total *P. oceanica* biomass. *Caulerpa* spp. biomass was also determined and after drying the fronds and stolons for 24 hours at 60°C, the dry weight was quantified.

Species of decapod crustaceans were sorted out using a stereomicroscope and identified at the lowest possible taxonomic level. Samples were fixed in 10% formaldehyde and preserved in ethanol 70%.

Sediment characteristics were determined by sampling with cores. Three cores per site were inserted 5 cm deep into the sediment in each meadow to characterize the grain size parameters. After eliminating organic matter using H₂O₂, sediment was dried for 24 h and grain size fractions were established following the Wentworth scale.

Statistical analysis

In order to characterise the community, the different *P. oceanica* fractions (dead leaves, live leaves, rhizomes, roots and sheaths) were taken into account. To test for differences among meadows, a two-way ANOVA was carried out (factors meadow and time) for each *P. oceanica* fraction, expressed as contribution percentage.

Decapoda densities (ind. / m²) were fourth-root transformed and the Bray-Curtis similarity matrix was calculated. Based in this similarity matrix, species contribution to the similarity of each meadow and dissimilarity among meadows were calculated using SIMPER (PRIMER 5.0).

To test the importance of the contribution of abiotic factors such as the granulometry, *Posidonia oceanica* fractions biomass and *Caulerpa* biomass variables, Pearson correlations were performed between these variables and the decapoda species densities.

A multidimensional scaling (MDS) (PRIMER 5.0) was performed to test for differences in decapoda densities between non-invaded *P. oceanica* meadows and the samples with the three *Caulerpa* species and among the three different *Caulerpa* samples categories. To avoid the presence of occasional species in statistical analyses, species with less than 8 individuals of total abundance were excluded from the analyses.

The number of species, Shannon-Wiener and Jaccard indexes were calculated using the DIVERSE routine (PRIMER 5.0). Two-way ANOVA (factors meadow, time) were performed to study seasonal changes in the diversity indices.

Results

Characterisation of the non-invaded and invaded *Posidonia oceanica* meadows

There were significant differences in the contribution percentages of the *P. oceanica* structural components among the studied meadows (Table 1). The sheath fraction was predominant at the four studied meadows but significant differences among meadows were found (ANOVA, $p < 0.05$). In the *P. oceanica* pristine meadow, live leaves represented the second dominant fraction, while *Posidonia* roots was the second dominant fraction at those samples with *C. prolifera* and *C. racemosa*. Finally, seagrass rhizomes was the second most important fraction at samples with *C. taxifolia* (Fig 2).

Table 1.- Characterisation of the different meadows studied in terms of vegetated fractions. A: ANOVA to test difference among meadows (*Caulerpa prolifera*, *C. taxifolia*, *C. racemosa*, *P. oceanica*) and sampling dates. *** very high significant differences (ANOVA, $p < 0.001$), ** high significant differences (ANOVA, $p < 0.01$), * significant differences (ANOVA, $p < 0.05$). Tukey analysis results: a = significant difference between *C. prolifera* and *C. racemosa* samples; b = significant differences between *C. prolifera* and *C. taxifolia*; c = significant differences between *C. prolifera* and *P. oceanica*; d = significant differences between *C. racemosa* and *C. taxifolia*; e = significant differences between *C. racemosa* and *P. oceanica*; f = significant differences between *C. taxifolia* and *P. oceanica*

		%Weight rhizomes	%Weight sheath	%Weight live leaves	%Weight dead leaves	%Weight roots
<i>Source of variation</i>	df	MS	MS	MS	MS	MS
Date	8	147.601	596.416*	191.730	4.040	272.534
Meadow	3	400.753**e	1543.703**a,d	2517.670***c,e,f	5.364	1383.052***c,b,d,e
Meadow * d ate	24	147.767	863.469***	135.579	3.946	364.144**
Residual	72	91.877	268.190	103.301	3.095	173.967

There were significant differences in grain size fractions among meadows (ANOVA $p < 0.05$). Thus, samples with *Caulerpa prolifera* were characterized by a predominance of very fine sands (predominant fraction 125 μm) along the two years of sampling. Samples with *C. taxifolia* and the *P. oceanica* pristine meadow were characterized by the predominance of the fine sand fraction (250 μm). Samples with *C.*

racemosa showed an interannual variability in grain size linked to the medium sands (500 µm fraction) of the 2003 year and predominance of the fine sands in 2004 .



Figure 2: Mean *Posidonia oceanica* fractions percentage value for *Caulerpa* mats and *P. oceanica* seagrass.

The biomass of *C. taxifolia* and *C. racemosa* showed temporal variations, with maximum biomass values in summer 2003 and summer-autumn 2004 (Fig. 3). *C. prolifera* had maximum biomass values in winter in the two sampled years. The biomass of *C. prolifera* was always higher than that of *C. racemosa* and *C. taxifolia* (Fig. 3).

Faunistic composition and temporal variability in non-invaded and invaded habitats

In non-invaded, pristine, *P. oceanica* meadows, a total of 466 individuals belonging to 19 decapod crustacean species were sampled during the two years of the study. The highest densities and dominant values were shown by the caridean shrimp *Athanas nitescens*, the hermit crab *Calcinus tubularis* and the squat lobster *Galathea bolivari* (Table 2). Concerning frequency of occurrence, the highest value corresponded to *C. tubularis*.

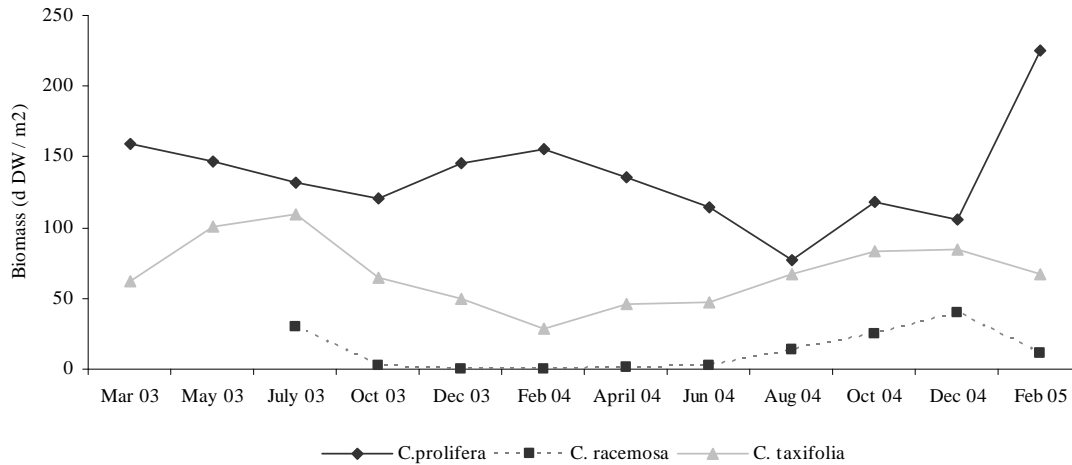

Figure 3: Temporal variations of the *Caulerpa prolifera*, *C. racemosa* and *C. taxifolia* biomass expressed as g dry weight/m².

A total of 964 decapod crustacean individuals belonging to 18 species were sampled in *P. oceanica* meadows with *Caulerpa prolifera* (Table 3). The highest densities and dominant values were shown by the caridean shrimp *Athanas nitescens*, the hermit crab *Calcinus tubularis* and the crab *Xantho pilipes*. Concerning frequency of occurrence, the highest value corresponded to *X. pilipes*, occurring in almost all samples, followed by *C. tubularis* and *A. nitescens*.

In *P. oceanica* meadows with the invasive *Caulerpa racemosa*, a total of 1812 decapod crustaceans belonging to 17 species were sampled (Table 4). The highest densities and dominant values were shown by *Athanas nitescens*, *G. bolivari* and the hermit crab *Cestopagurus timidus*. Concerning frequency of occurrence, the highest value corresponded to *A. nitescens*, followed by *G. bolivari* and the thalassinid shrimp *Upogebia mediterranea*.

Samples corresponding to *P. oceanica* meadows with the invasive *C. taxifolia* showed a total abundance of 1175 decapod individuals grouped in 19 different species (Table 5). The highest densities and dominant values were shown by *Athanas nitescens* and *Calcinus tubularis*, followed by *Cestopagurus timids*, *Ebalia edwardsii*, *Alpheus dentipes*, *Galathea bolivari*, *Xantho polipes* and *Achaeus cranchii*. Concerning frequency of occurrence, the highest value corresponded to *Calcinus tubularis*, followed by *Athanas nitescens*, *Ebalia edwardsii* and *Cestopagurus timidus*.

Differences among meadows

Some significant differences were found among the studied decapod assemblages corresponding to the studied habitats (ANOSIM, Table 6). An MDS plot (Fig. 4) showed a partial grouping of *Caulerpa* samples rounded by *P. oceanica* samples for the three *Caulerpa*, but more clearly for *C. prolifera*. Higher dissimilarities among meadows correspond to *P. oceanica* and *Caulerpa*. Decapoda assemblages were more similar among the *Caulerpa* species than between *P. oceanica* seagrass and *Caulerpa* species (SIMPER, Table 6).

Main differences between seagrass and *Caulerpa* species must be interpreted in terms of abundance variation of decapoda species. *Athanas nitescens* was more abundant in the three *Caulerpa* species than in *Posidonia oceanica*. Higher abundances of *Xantho pilipes* in *C. prolifera* are directly related to promote differences between *C. prolifera* and *P. oceanica*. Most important differences between *C. prolifera* and *C. taxifolia* were mainly due to highest abundances of *X. pilipes* in *C. prolifera*. Higher abundances of *Galathea bolivari* and *A. nitescens* in *C. racemosa* than *C. prolifera* were responsible of most important differences between *C. prolifera* and *C. racemosa*. The most important differences between *C. racemosa* and *C. taxifolia* were also due to higher abundances of *G. bolivari* and *A. nitescens* in *C. racemosa* than *C. taxifolia* (Table 6).

Table 2.- Density (individuals/m²) temporal variation in decapod crustacean species present in pristine *Posidonia oceanica* meadows located at Cala d'Or (E Mallorca). Ni: total number of individuals / m², Di: dominance values (number individuals of each species / total number of individuals), Fi: frequency of occurrence (number of samples with presence of each species / total number of samples).

<i>Posidonia oceanica</i>	Mar-03	May-03	Jul-03	Oct-03	Dec-03	Feb-04	Apr-04	Jun-04	Aug-04	Oct-04	Dec-04	Feb-05	Ni	Di	Fi
<i>Athanas nitescens</i>	42	0	0	0	0	0	8	0	8	0	25	0	83	17.86	0.33
<i>Calcinus tubularis</i>	0	8	17	8	8	0	0	33	8	0	0	0	82	17.86	0.50
<i>Galathea bolivari</i>	8	0	0	8	0	0	8	0	17	0	0	17	58	12.50	0.42
<i>Pisa muscosa</i>	0	0	0	0	0	8	8	0	0	0	8	8	32	7.14	0.33
<i>Alpheus dentipes</i>	8	0	0	0	0	17	0	0	0	0	0	0	25	5.36	0.17
<i>Galathea cenanroii</i>	0	0	0	0	0	0	0	17	0	0	0	8	25	5.36	0.17
<i>Alpheus macrocheles</i>	0	0	0	0	0	25	0	0	0	0	0	0	25	5.36	0.08
<i>Achaeus cranchii</i>	8	0	8	0	0	0	0	8	0	0	0	0	24	5.36	0.25
<i>Illia nucleus</i>	0	0	0	0	0	0	0	0	8	0	0	8	16	3.57	0.17
<i>Pisidia longimana</i>	8	0	0	0	0	0	8	0	0	0	0	0	16	3.57	0.17
<i>Automate branchialis</i>	0	0	0	0	0	0	0	0	0	8	0	0	8	1.79	0.08
<i>Cestopagurus timidus</i>	0	0	8	0	0	0	0	0	0	0	0	0	8	1.79	0.08
<i>Dromia personata</i>	0	0	8	0	0	0	0	0	0	0	0	0	8	1.79	0.08
<i>Ebalia edwardsii</i>	0	0	0	8	0	0	0	0	0	0	0	0	8	1.79	0.08
<i>Macropodia longirostris</i>	0	0	0	0	0	0	0	0	8	0	0	0	8	1.79	0.08
<i>Pagurus anachoretus</i>	8	0	0	0	0	0	0	0	0	0	0	0	8	1.79	0.08
<i>Pilumnus hirtellus</i>	0	0	0	0	0	0	0	0	0	0	8	0	8	1.79	0.08
<i>Xantho incisus</i>															
<i>granulicarpus</i>	0	0	0	0	0	0	8	0	0	0	0	0	8	1.79	0.08
<i>Xantho pilipes</i>	0	0	0	0	0	0	8	0	0	0	0	0	8	1.79	0.08

Table 3.- Density (individuals/m²) temporal variation in decapod crustacean species present in samples with *Caulerpa prolifera*, located at Cala d'Or (E Mallorca). Ni: total number of individuals / m², Di: dominance values (number individuals of each species / total number of individuals), Fi: frequency of occurrence (number of samples with presence of each species / total number of samples).

<i>Caulerpa prolifera</i>	Mar-03	May-03	Jul-03	Oct-03	Dec-03	Feb-04	Apr-04	Jun-04	Aug-04	Oct-04	Dec-04	Feb-05	Ni	Di	Fi
<i>Athanas nitescens</i>	8	0	42	0	0	25	0	0	17	150	17	0	259	26.72	0.50
<i>Calcinus tubularis</i>	8	8	42	17	0	0	0	33	0	17	0	92	217	22.41	0.58
<i>Xantho pilipes</i>	17	8	8	8	17	25	25	0	8	33	17	17	183	18.97	0.92
<i>Cestopagurus timidus</i>	0	0	17	0	0	0	0	0	0	0	0	25	42	4.31	0.58
<i>Sirpus zariquieyi</i>	0	8	0	0	17	0	0	0	8	0	8	0	41	4.31	0.33
<i>Upogebia pusilla</i>	0	0	0	0	0	8	0	25	0	0	8	0	41	4.31	0.25
<i>Upogebia mediterranea</i>	0	0	8	0	8	8	8	0	0	8	0	0	40	4.31	0.42
<i>Processa</i> sp.	0	0	0	0	0	0	0	8	0	17	0	0	25	2.59	0.17
<i>Galathea squamifera</i>	0	0	0	0	0	0	0	0	0	0	0	17	17	1.72	0.08
<i>Liocarcinus arcuatus</i>	0	0	0	0	0	0	0	17	0	0	0	0	17	1.72	0.08
<i>Galathea bolivari</i>	0	0	8	0	0	0	0	8	0	0	0	0	16	1.72	0.17
<i>Achaeus cranchii</i>	0	0	0	0	0	0	8	0	0	0	0	0	8	0.86	0.08
<i>Alpheus dentipes</i>	0	0	0	8	0	0	0	0	0	0	0	0	8	0.86	0.08
<i>Automate branchialis</i>	0	0	8	0	0	0	0	0	0	0	0	0	8	0.86	0.08
<i>Ilia nucleus</i>	0	0	0	0	0	0	0	8	0	0	0	0	8	0.86	0.08
<i>Liocarcinus corrugatus</i>	0	8	0	0	0	0	0	0	0	0	0	0	8	0.86	0.08
<i>Pilumnus hirtellus</i>	0	0	0	0	0	8	0	0	0	0	0	0	8	0.86	0.08
<i>Pisa</i> sp.	0	0	0	0	0	0	0	0	0	8	0	0	8	0.86	0.08

Table 4.- Density (individuals/m²) temporal variation in decapod crustacean species present in samples with *Caulerpa racemosa*, located at Portals Vells (W Mallorca). Ni: total number of individuals / m², Di: dominance values (number individuals of each species / total number of individuals), Fi: frequency of occurrence (number of samples with presence of each species / total number of samples).

<i>Caulerpa racemosa</i>	Jul-03	Oct-03	Dec-03	Feb-04	Apr-04	Jun-04	Aug-04	Oct-04	Dec-04	Nov-04	Feb-05	Ni	Di	Fi
<i>Athanas nitescens</i>	17	25	0	0	33	50	67	150	100	75	42	559	30.80	0.82
<i>Galathea bolivari</i>	25	0	0	0	17	25	33	100	100	88	8	396	21.84	0.73
<i>Cestopagurus timidus</i>	0	25	0	0	25	42	67	33	0	0	0	192	10.57	0.45
<i>Upogebia mediterranea</i>	0	8	0	0	8	25	17	42	17	17	8	142	7.82	0.73
<i>Xantho pilipes</i>	8	8	25	0	0	33	0	50	17	0	0	141	7.82	0.55
<i>Calcinus tubularis</i>	0	25	17	0	25	17	0	0	8	8	0	100	5.52	0.64
<i>Galathea squamifera</i>	8	8	0	0	8	17	33	17	0	0	0	91	5.06	0.55
<i>Alpheus dentipes</i>	0	0	0	0	8	0	0	25	33	25	0	91	5.06	0.33
<i>Sirpus zariquieyi</i>	0	8	0	0	0	0	8	8	0	0	0	24	1.38	0.27
<i>Pisa muscosa</i>	0	0	0	0	8	0	0	8	0	0	0	16	0.92	0.18
<i>Macropodia linaresi</i>	0	0	0	0	8	0	0	0	0	0	0	8	0.46	0.09
<i>Pagurus anachoretus</i>	0	0	8	0	0	0	0	0	0	0	0	8	0.46	0.09
<i>Pilumnus hirtellus</i>	0	0	0	0	0	0	0	0	0	0	8	8	0.46	0.09
<i>Processa edulis</i>	0	0	0	0	0	0	0	8	0	0	0	8	0.46	0.09
<i>Processa sp.</i>	0	0	0	0	0	0	0	0	8	0	0	8	0.46	0.09
<i>Upogebia pusilla</i>	0	0	0	0	0	0	0	8	0	0	0	8	0.46	0.09
<i>Achaeus cranchii</i>	0	0	0	0	0	0	0	0	0	8	0	8	0.46	0.08

Table 5.- Density (individuals/m²) temporal variation in decapod crustacean species present in samples with *Caulerpa taxifolia*, located at Cala d'Or (E Mallorca). Ni: total number of individuals / m², Di: dominance values (number individuals of each species / total number of individuals), Fi: frequency of occurrence (number of samples with presence of each species / total number of samples).

<i>Caulerpa taxifolia</i>	Mar-03	May-03	Jul-03	Oct-03	Dec-03	Feb-04	Apr-04	Jun-04	Aug-04	Oct-04	Dec-04	Feb-05	Ni	Di	Fi
<i>Athanas nitescens</i>	0	0	17	17	0	0	25	17	25	33	83	25	242	20.57	0.67
<i>Calcinus tubularis</i>	8	17	8	50	8	0	8	8	25	42	8	0	182	15.60	0.83
<i>Ebalia edwardsii</i>	33	0	0	17	8	8	25	0	0	8	17	0	116	9.93	0.58
<i>Galathea bolivari</i>	0	0	0	0	0	0	0	25	8	42	8	17	100	8.51	0.42
<i>Alpheus dentipes</i>	0	0	0	8	25	17	0	0	17	0	33	0	100	8.51	0.42
<i>Cestopagurus timidus</i>	17	8	0	8	0	8	17	0	0	0	8	17	83	7.09	0.58
<i>Achaeus cranchii</i>	0	0	8	33	0	0	8	8	0	25	0	0	82	7.09	0.42
<i>Xantho pilipes</i>	0	0	8	17	0	8	0	0	0	8	8	0	49	4.26	0.42
<i>Sirpus zariquieyi</i>	0	17	0	8	0	0	0	0	8	8	0	0	41	3.55	0.33
<i>Processa</i> sp.	0	0	0	0	0	0	0	17	8	0	8	0	33	2.84	0.25
<i>Ilia nucleus</i>	0	0	0	8	0	0	8	0	8	0	8	0	32	2.84	0.33
<i>Pisa muscosa</i>	0	0	8	0	0	8	0	8	0	0	0	0	24	2.13	0.25
<i>Alpheus macrocheles</i>	0	0	0	0	0	0	8	8	0	0	0	0	16	1.42	0.17
<i>Automate branchialis</i>	0	0	0	0	0	0	0	0	0	8	0	8	16	1.42	0.17
<i>Pisa tetradon</i>	0	0	0	0	0	0	0	0	8	8	0	0	16	1.42	0.17
<i>Hippolyte</i> sp.	0	0	0	0	0	0	0	0	8	0	0	0	8	0.71	0.08
<i>Macropodia longirostris</i>	0	0	0	0	0	0	0	0	0	8	0	0	8	0.71	0.08
<i>Pagurus anachoretus</i>	0	0	0	0	0	0	0	0	0	8	0	0	8	0.71	0.08
<i>Upogebia pusilla</i>	0	0	0	0	0	0	8	0	0	0	0	0	8	0.71	0.08

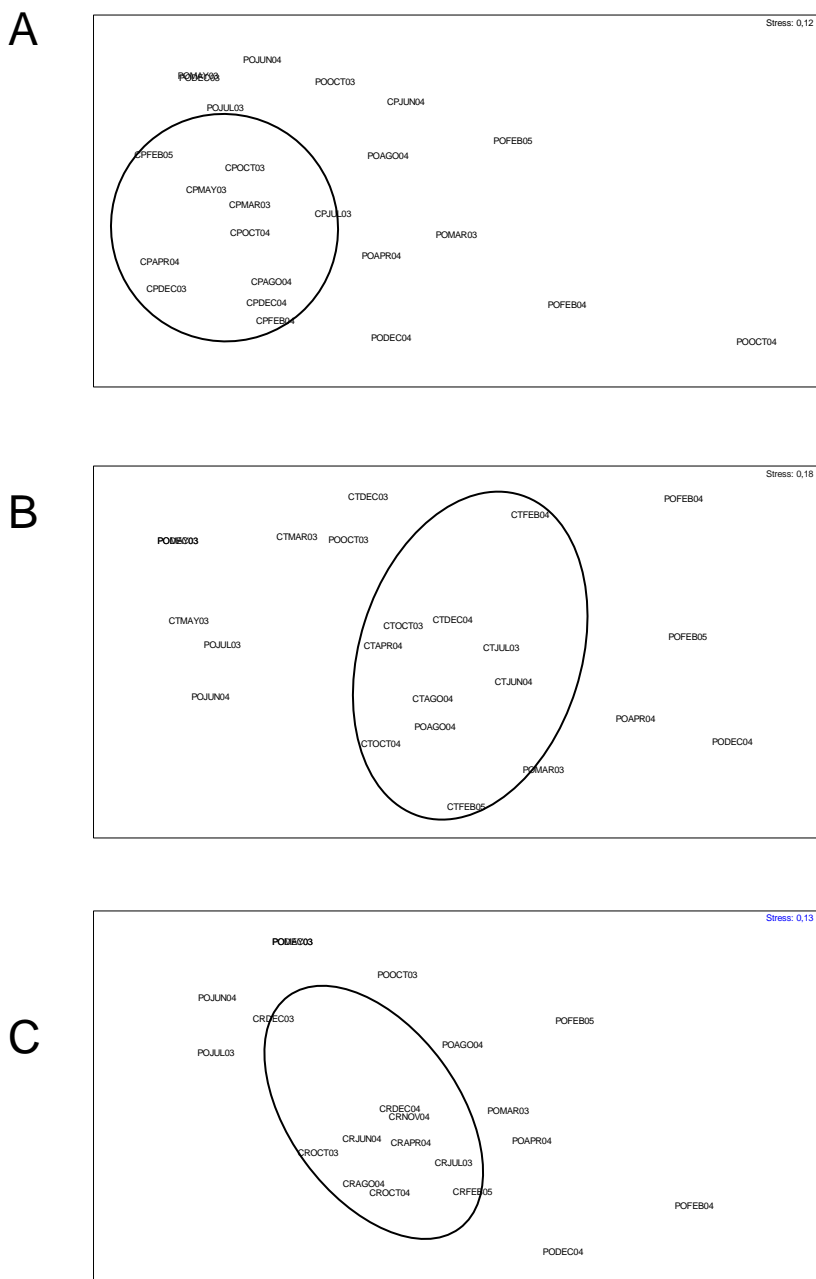

Figure 4: MDS ordination plots of bimonthly samples based on the fourth root of the number of decapod individuals per square meter. (A) Comparison between *Caulerpa prolifera* (cp) (encircled) and *Posidonia oceanica* (po). (B) Comparison between *P. oceanica* (po) samples versus *C. taxifolia* (ct) (encircled). (C) Comparison between *P. oceanica* (po) samples versus *C. racemosa* (cr) (encircled).

Table 6.- ANOSIM differences among studied meadows and SIMPER dissimilarity values between meadow pairs and most contributing decapoda species to the dissimilarity values (in bold). AA: average abundance . DS: contribution to the dissimilarity percentage between meadows pairs. PO: *Posidonia oceanica* samples, CP: *Caulerpa prolifera* samples, CT: *C. taxifolia* samples, CR: *C. racemosa* samples.

ANOSIM					PO-CP	PO-CT	PO-CR	CP-CT	CP-CR	CT-CR
Global R					0.383	0.150	0.345	0.345	0.255	0.308
P					0.001	0.035	0.001	0.001	0.001	0.002
SIMPER	AA. PO	AA. CP	AA. CT	AA. CR	Contr. DS PO-CP	Contr. DS PO-CT	Contr. DS PO-CR	Contr. DS CP-CT	Contr. DS CP-CR	Contr. DS CT-CR
<i>Galathea. bolivari</i>	5.30	1.39	8.33	39.58	6.95	7.84	10.71	5.91	13.74	9.84
<i>Athanas nitescens</i>	7.58	21.53	20.14	55.83	10.62	10.16	13.21	9.62	12.73	8.95
<i>Calcinus tubularis</i>	7.58	18.06	15.28	10.00	10.52	8.27	7.65	8.62	9.18	6.62
<i>Upogebia mediterranea</i>	0.00	3.47	0.00	14.17	6.13		10.25	5.12	8.88	9.36
<i>Cestopagurus timidus</i>	0.76	3.47	6.94	19.17	3.66	9.26	7.57	8.50	8.51	7.93
<i>Galathea squamifera</i>		1.39	0.00	9.17			7.56		8.31	6.87
<i>Xantho pilipes</i>	0.76	15.28	4.17	14.17	16.37	5.51	9.04	10.14	8.02	7.37
<i>Sirpus zariquieyi</i>	0.00	3.47	3.47	2.50	6.42	4.53	3.03	6.34	6.17	4.64
<i>Aalpheus dentipes</i>	2.27	0.69	8.33	9.17	3.81	6.54	5.78	6.63	6.02	6.64
<i>Upogebia pusilla</i>	0.00	3.47	0.69	0.83	3.78			3.71	3.84	
<i>Processa sp.</i>	0.00	2.08	2.78	0.83	2.18	2.99		3.96	2.85	3.02
<i>Pilumnus hirtellus</i>	0.76	0.69		0.83	2.37		2.53		2.54	
<i>Ebalia edwardsii</i>	0.76	0.00	9.72	0.00		9.22		8.47		7.21
<i>Achaeus cranchii</i>	2.27	0.69	0.83	6.94	4.69		3.70	5.44		4.73
<i>Illia nucleus</i>	1.52	0.69	2.78	0.00	3.11	4.64		3.72		2.92
<i>Pisa muscosa</i>	3.03	0.00	2.08	1.67	5.31	6.10	4.82	3.38		3.69
<i>Automate. branchialis</i>	0.00	0.69	1.39			2.14		2.51		
<i>Pagurus anachoretus</i>	0.76		0.83	0.69			2.58			2.03
<i>Galathea cenarroi</i>	2.27	0.00	0.00	0.00	2.94	2.71	2.37			
<i>Pisida longimana</i>	1.52	0.00			2.19					
<i>Alpheus macrocheles</i>	2.27		1.39			3.31				
Average Dissimilarity between meadows pairs					81.90	73.00	76.36	71.34	63.01	66.10

Effects of the habitat structure over decapoda assemblages

The effect of the structural parameters over the decapoda assemblages differ among meadows. In *Posidonia oceanica* seagrass meadow only *Athanas nitescens* abundances were related to structural parameters (Table 7). For native *Caulerpa prolifera* correlations were found with structural parameters for the species *Athanas nitescens* and *Calcinus tubularis* (Table 7). The structural parameters for invasive *C. racemosa* were correlated with the decapoda species *A. nitescens*, *Calcinus timidus*,

Galathea squamifera, *Galathea bolivari*, *Upogebia mediterranea* and *Xantho pilipes* (Table 7).

Diversity indexes

Species richness (number of species) in non-invaded *Posidonia oceanica* samples ranged between one (May, December 2003 and October 2004) and six species (March 2003, April 2004) (Fig. 5 a). Maximum diversity values (Shannon-Wiener index) were obtained in March 2003 and April 2004 (Fig. 5 b). In meadows with *C. prolifera*, species richness ranged between 3 and 7 species, with maximum values corresponding to the summer season (July 2003 and June 2004) (Fig 5 a, b). In meadows with the invasive *C. taxifolia*, species richness ranged between 3 and 11 species, with maximum values in October 2003 and October 2004 with 9 species (Fig. 5 a, b). In samples with the invasive *C. racemosa*, species richness ranged between no decapod presence and 11 species, with maximum values in October 2003 (7 species) and October 2004 (11 species) (Fig. 5 a, b).

Significant differences in diversity, species richness and in seasonality were found among meadow categories (Table 8) Thus, Tukey analysis found significant differences between *C. taxifolia* and *P. oceanica* meadows, as well as between December 2003 - February 2004 and the spring-summer samples (April-June 2004, August October 2004). The highest number of species was found in late spring and summer, coeval to the maximum growth of the *Caulerpa* mats, especially in the non-native *Caulerpa* samples (Fig. 5). The Shannon-Wiener index showed also significant differences among meadows (ANOVA, $p < 0.05$) and Post-Hoc analysis revealed significant differences between *C. taxifolia* and *P. oceanica* samples. (Table 8).

The other invasive *Caulerpa*, *C. taxifolia*, structural parameters of the habitat were correlated with the abundances of *A. nitescens* and *Ebalia edwardsii* (Table 7).

a)

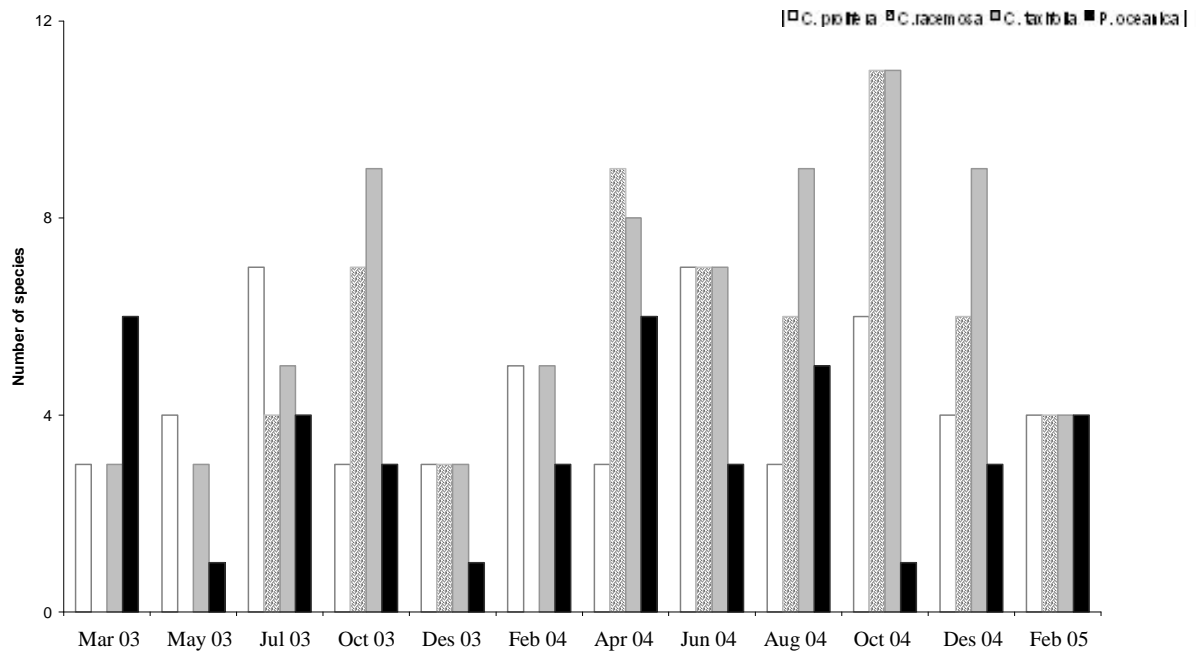

b)

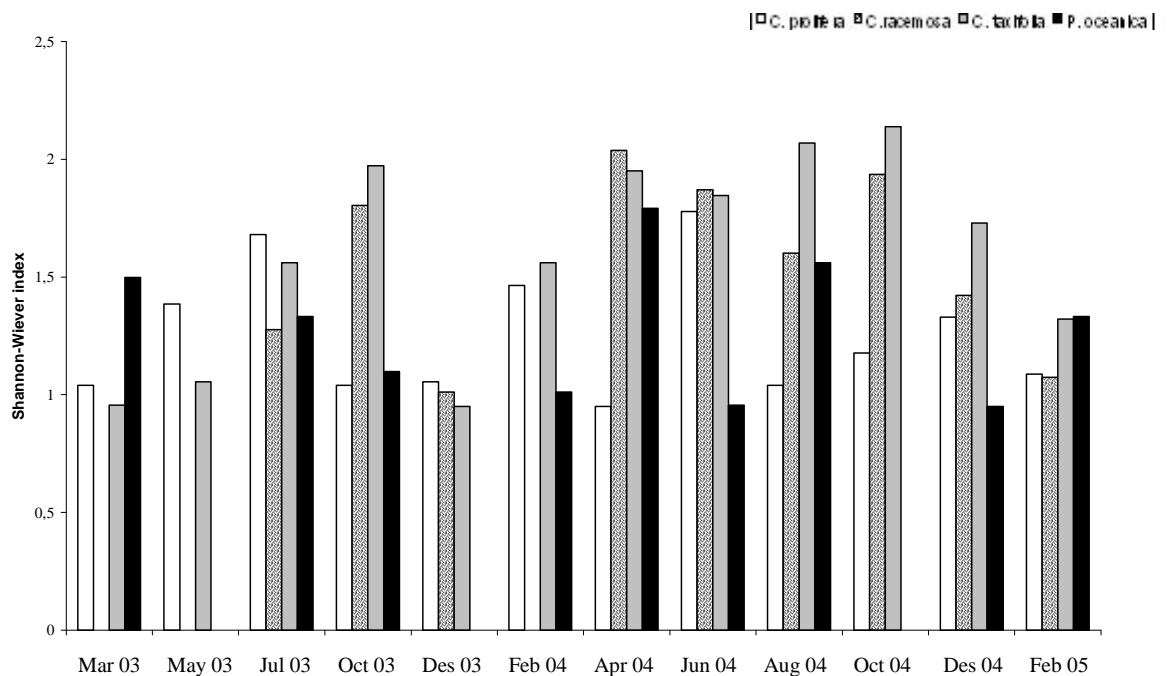

Figure 5: a) Bimonthly mean number of decapod species for the *Caulerpa* mats and *Posidonia oceanica* seagrass. b) Bimonthly mean values of Shannon-Wiener diversity Index for *Caulerpa* mats and *Posidonia oceanica* seagrass.

Table 8.- ANOVA of the total number of species (S), number of individuals (N), Jaccard index (J'), Shannon-Wiener index (H) and 1- Lambda index. ***: very high significant differences (ANOVA, $p < 0.001$), **: high significant differences (ANOVA, $p < 0.01$), *: significant differences (ANOVA, $p < 0.05$). Tukey analysis results a = significant differences between *Caulerpa racemosa* and *Posidonia oceanica*; b = significant differences between *C. taxifolia* and *P. oceanica*.

		S	N	J'	H
Source of variation	df	MS	MS	MS	MS
Meadow	3	25.225 ^{**b}	24680.99 ^{**a}	0.008	0.934 ^{**b}
Date	4	16.750 [*]	15244.792	0.010	0.462
Meadow*date	12	3.433	4985.532	0.002	0.106
Residual	20	4.425	4630.642	0.005	0.174

Discussion

The colonisation and substitution of the *Posidonia oceanica* meadows by *Caulerpa* mats change habitat structural parameters and the seasonal vegetal coverage. Each *Caulerpa* species present particular structural characteristics, seasonality patterns, toxicity and different arrival date. Altogether induces changes over the decapoda community previously associated with the seagrass *P. oceanica*. Main finding of present study is the higher decapoda abundances and diversity in non-native *Caulerpa* mats than *P. oceanica* seagrass meadow. However, dominant species found in *Caulerpa* mats are common in *P. oceanica* seagrass meadows (including alive and dead mats) (Templado 1984; Chimenz et al. 1989; Garcia-Raso 1990; Garcia-Raso et al. 1996; Templado et al. 2004; Borg et al. 2005).

Nowadays the degradation of seagrass meadows by several factors such as anchoring, pollution and eutrophication, among others, leaves a nude substratum susceptible to be colonised by *Caulerpa* species. Each *Caulerpa* generates a particular habitat over dead rhizomes, different from the other congeneres. *Caulerpa* species present a water temperature dependent growing cycle with higher biomass in the post-summer period with higher temperatures (Terrados and Ros 1995; Thibaut et al. 2004).

However we found species differences in biomass seasonality among *Caulerpa* species. Apart from the differences in biomass seasonality, the different time of substrate colonisation is responsible for increase or decrease differences between the original seagrass meadow and the actual *Caulerpa* mats. The different contribution percentages of the *P. oceanica* fractions among *Caulerpa* species must be also considered. It implies differences in the habitat promoting or reducing the occurrence of spaces and crevices in the mats. Another important parameter to differentiate between *Caulerpa* mats and *P. oceanica* meadow is the presence of caulerpenyne, a secondary metabolite in *Caulerpa* macroalgae (Jung et al. 2002; Sureda et al. 2006).

The sampling methodology was appropriate for the infaunal decapoda community but the vagile decapoda was not fully sampled. Motile species such as shrimps of the genus *Hippolyte* and *Palaemon* dominant in previous works on *C. prolifera* (Sanchez-Moyano et al. 2001b; de la Rosa et al. 2002; Sanchez-Moyano et al. 2004; de la Rosa et al. 2006) and *P. oceanica* (Garcia-Raso 1990; Garcia-Raso et al. 1996; Sanchez-Jerez et al. 1999; Sanchez-Jerez et al. 2000) here show a low presence in the rhizome substratum, indicating a sampling bias.

The non-native *Caulerpa* considered recent invaders in the Balearic waters do not have an own decapoda infauna community. Therefore, the decapoda endofauna of the non-native *Caulerpa* is highly influenced by the *Posidonia oceanica* seagrass beds. The native Mediterranean *C. prolifera* mats have been growing over dead *P. oceanica* mats for a longer period than the non-native *Caulerpa* and has associated a decapoda community that has developed adaptative mechanisms to feed and inhabit *C. prolifera* mats. Multidimensional scaling analysis (MDS) showed grouping trends in the *Caulerpa* mats. These trends were ever clearer when *C. prolifera* mat and *P. oceanica* meadow were compared.

The general trend in the decapoda endofauna is the important coincidence of the species composition between *Caulerpa* mats and *Posidonia oceanica*. Most important differences were due to enhanced abundances of *P. oceanica* decapoda species in *Caulerpa* mats. *P. oceanica* species associated with rhizome substratum such as *Calcinus tubularis*, *Cestopagurus timidus*, *Athanas nitescens*, *Alpheus dentipes* and *Galathea bolivari* (Templado et al. 2004) were most abundant species in *Caulerpa* mats. The hermit crabs *Cestopagurus timidus* and *Calcinus tubularis*, which could reach 50% of the decapoda endofauna in *P. oceanica* meadows (Templado et al. 2004), increased abundances in *Caulerpa* mats. This trend had been previously reported in a

deeper habitat (30 meters) where both species increases its abundances when *C. racemosa* colonised the space previously occupied by *P. oceanica* seagrass (Argyrou et al. 1999).

The substrate studied colonised by *Caulerpa* species is a particular habitat with important presence of species which usually inhabit hollows and crevices in the *Posidonia oceanica* dead mats and *P. oceanica* meadows such as *Athanas nitescens*, *Alpheus dentipes* and *Galathea bolivari*, (Garcia-Raso 1990; Garcia-Raso et al. 1996; Borg et al. 2006). As previously reported by Borg *et al* (2006) for the dead matte, in our study these decapoda species present higher abundances in *Caulerpa* mats than *P. oceanica* meadows and contribute mostly to the dissimilarity between *Caulerpa* and *P. oceanica* decapoda assemblages.

Posidonia oceanica mats are a suitable substrate for decapod species such as *Upogebia* (Garcia-Raso 1990; Garcia-Raso et al. 1996), which create large feeding galleries (Waldbusser and Marinelli 2006) and live inside the *Posidonia oceanica* mat. *Upogebia mediterranea* presents higher abundances in *Caulerpa racemosa* and *C. prolifera* than at *P. oceanica* and contributes importantly to the dissimilarity between these *Caulerpa* mats and *P. oceanica*. The presence of genus *Upogebia* had been described for *C. prolifera* (de la Rosa et al. 2002) but not for *C. racemosa* (Argyrou et al. 1999). *U. mediterranea* ventilate their borrows creating an environment rich in organic matter and oxygen, which favours bacterial growth. That may lead to a more rapid decomposition of seagrass tissues (Borg et al. 2006).

The crab *Xantho pilipes* was more abundant in the three *Caulerpa* mats than in *Posidonia oceanica* meadow. This crab, common in shallow waters, is more frequent in rocky bottoms but is also present in seagrass meadows (Zariquiey 1968). *X. pilipes* was common in *C. prolifera* mat being also responsible for large part of differences between *C. prolifera* with *C. taxifolia* and *P. oceanica*. *C. racemosa* mat community had also an important presence of this species but no previous reports of this species in *C. racemosa* mat had been found (Argyrou et al. 1999) which supports the hypothesis that *X. pilipes* is an opportunistic species and *Caulerpa* mats provides a useful habitat to this specie.

Another crab, *Ebalia edwardsii*, was one of the species with high contribution to the SIMPER similarity value of *Caulerpa taxifolia* mat. The presence of this species had been reported in *P. oceanica* seagrass meadows (Garcia-Raso 1990; Garcia-Raso et al. 1996) but not in dead seagrass mats (Borg et al. 2006). *E. edwardsii* is a common species in sandy bottoms and seagrasses (Zariquiey 1968).

The correlations among decapoda species and sample characteristics mainly revealed the importance of grain size for species such as for *Athanas nitescens*, *Galathea bolivari* and *Upogebia mediterranea*. The correlations found for one meadow are not applicable to others and no general trends regarding the effects of the sample structural parameters over the decapoda species could be established. The structural *P. oceanica* fractions also influenced some decapoda species such as *A. nitescens*, *C. timidus* and *G. squamifera*. *Caulerpa* biomass only affected the presence of *C. tubularis* in *C. prolifera*. Consequently, the decapoda infauna community was more affected by changes in the sediment structural parameters such as grain size. The presence of *Caulerpa* biomass did not seem to be the main factor directly responsible for the changes in the infaunal decapoda community. However, the presence of *Caulerpa* species enhances the sedimentation rates (Piazzi et al. 2005) and in the case of *C. prolifera* it provides a reduction of grain size in the colonised area (Sanchez-Moyano et al. 2001a).

Caulerpa mats seemed to increase the decapoda species diversity, which occurs along with higher *Caulerpa* biomass in late summer (*C. racemosa* and *C. taxifolia*), and in late spring-summer (*C. prolifera*). Consequently the habitat generated by *Caulerpa* species seems to enhance decapoda diversity related to the occurrence of maximum *Caulerpa* biomass. Many authors proposed mechanisms by which variations of habitat architecture may influence the composition and distribution of the associated assemblages (Dean and Connell 1987; Bologna and Heck 2000). The three *Caulerpa* mats have different foliar structure with different length, ramification degree, biomass and seasonality. This habitat is completely different from the large lineal leaves of *P. oceanica* meadow. *Caulerpa* species form a complex stolon structure over the dead mats, generating a more complex habitat and increasing decapoda abundances. *C. taxifolia* develops a network of stolons on the substratum surface and possesses a rhizoid system that allows to colonize any substratum, affecting negative endemic macroalgae (Levi and Francour 2004). Specialized fishes such as *Mullus surmuletus*, by increasing a barrier to reach food resources are also affected negatively (Longepierre et al. 2005).

Conclusion

The decapoda community of invasive *Caulerpa* species and the one corresponding to *Posidonia oceanica* seagrass are similar in species composition. However, several decapoda species common in *P. oceanica* increase their abundances in invasive *Caulerpa*. Similarly occurs in *C. prolifera* with an important amount of coincident decapoda species with *P. oceanica* but different abundances. The substrate sampled seems to be at least in part responsible for these coincidences. The *Caulerpa* seasonality of each species, with different biomass and periodicity, seems to be also responsible for the differences in decapoda diversity. Our results suggest that maximum substrate coverage by each *Caulerpa* enhances decapoda diversity. The introduction of the non-native *Caulerpa* macroalgae increases the number of species and densities compared to the previous *P. oceanica* seagrass meadow and the Mediterranean *Caulerpa prolifera*. On the other hand the rhizome habitat seems to be a peculiar habitat selected by some decapoda species. The loose of the *Posidonia oceanica* aerial structures implies the increase of the abundances of these species which usually inhabits hollows and crevices such as *Athanas nitescens*, *Galathea bolivari*, *Alpheus dentipes* and *Upogebia mediterranea*. At each studied *Caulerpa* stations, the seagrass *P. oceanica* and the macroalgae of genus *Caulerpa* form a mixed habitat with patches of the two species. The progressive degradation of the seagrass by continued human perturbations might be on the side of *Caulerpa* macroalgae, which might expand its invasion forming monoespecific *Caulerpa* mats with important consequences over decapoda diversity and abundances.

Acknowledgements

This research was funded by Ministerio de Ciencia y Tecnología (Plan Nacional I+D (REN 2002-00701/MAR) The first author was founded by postgraduate research grant I3P FSE. We are most grateful to Dr J Terrados and Dra N Marbà for their help in sampling collection. Also we are most grateful to Dra I Moreno, Dr G Mateu-Vicens and Dr A Sureda for their manuscript comments.

References

- Argyrou M, Demetropoulos A, Hadjichristophorou M (1999) Expansion of the macroalga *Caulerpa racemosa* and changes in softbottom macrofaunal assemblages in Moni Bay, Cyprus. *Oceanologica Acta* 22: 517-528
- Ballesteros E, Grau AM, Riera F (1999) *Caulerpa racemosa* (Forsskal) J. Agardh (Caulerpales, Chlorophyta) in Mallorca (Western Mediterranean). *Bolletí Societat d'Història Natural de les Illes Balears* 42: 63-69
- BellanSantini D, Arnaud PM, Bellan G, Verlaque M (1996) The influence of the introduced tropical alga *Caulerpa taxifolia*, on the biodiversity of the Mediterranean marine biota. *Journal of the Marine Biological Association of the United Kingdom* 76: 235-237
- Bologna PAX, Heck KL (2000) Impacts of seagrass habitat architecture on bivalve settlement. *Estuaries* 23: 449-457
- Borg JA, Attrill MJ, Rowden AA, Schembri PJ, Jones MB (2005) Architectural characteristics of two bed types of the seagrass *Posidonia oceanica* over different spatial scales. *Estuarine Coastal and Shelf Science* 62: 667-678
- Borg JA, Rowden AA, Attrill MJ, Schembri PJ, Jones MB (2006) Wanted dead or alive: high diversity of macroinvertebrates associated with living and 'dead' *Posidonia oceanica* matte. *Marine Biology* 149: 667-677
- Boudouresque CF, Verlaque M (2002) Biological pollution in the Mediterranean Sea: invasive versus introduced macrophytes. *Marine Pollution Bulletin* 44: 32-38
- Buia MC, Gambi MC, Terlizzi A, Mazzella L (2001) Colonization of *Caulerpa racemosa* along the southern italian coast: I. Distribution, phenological variability and ecological role. In: Gravez V, Ruitton S, Boudouresque CF, Le Direac'h L, Meinesz A, G. S (eds) Fourth International Workshop on *Caulerpa taxifolia*. GIS Posidonie, France, pp 352-360
- Buia MC, Gambi MC, Zupo V (2000) Structure and functioning of mediterranean seagrass ecosystems: an overview. *Biologia Marina Mediterranea* 7: 167-190
- Chimenz C, Taramelli E, Cironi R, Contessini A, Gravina F, Maggiore F, Maj R, Motta M, Somaschini A (1989) Studies on animal populations of leaves and rhizomes of *Posidonia oceanica* (L.) Delile on the rocky bottom of Torvaldaliga. In:

- Boudouresque CF, Meinesz A, Fresi E, Gravez V (eds) International Workshop on Posidonia Beds. G.I.S Posidonie, Ischia (Italy), pp 145-155
- de la Rosa IL, Garcia-Raso JEG, Rodriguez A (2002) Evolution of a decapod community (Crustacea) of shallow soft bottoms with seaweeds from southern Europe. *Journal of the Marine Biological Association of the United Kingdom* 82: 85-95
- de la Rosa IL, Rodriguez A, Garcia-Raso JEG (2006) Seasonal variation and structure of a decapod (Crustacea) assemblage living in a *Caulerpa prolifera* meadow in Cadiz Bay (SW Spain). *Estuarine Coastal and Shelf Science* 66: 624-633
- Dean RL, Connell JH (1987) Marine-Invertebrates in an Algal Succession .3. Mechanisms Linking Habitat Complexity with Diversity. *Journal of Experimental Marine Biology and Ecology* 109: 249-273
- Ergen Z, Kocatas A, Katagan T, Onem M (1988) The distribution of Polychaeta and Crustacea found in *Posidonia oceanica* meadows of Izmir Bay (Turkey). *Rapp. Comm. int. Mer Médit* 31: 25
- Gambi MC, Lorenti M, Russo GF, Scipione MB, Zupo V (1992) Depth and Seasonal Distribution of Some Groups of the Vagile Fauna of the *Posidonia oceanica* Leaf Stratum - Structural and Trophic Analyses 13: 17-39
- Hillman K, McComb AJ, Walker DI (1995) The Distribution, Biomass and Primary Production of the Seagrass *Halophila ovalis* in the Swan-Canning Estuary, Western-Australia. *Aquatic Botany* 51: 1-54
- Jung V, Thibaut T, Meinesz A, Pohnert G (2002) Comparison of the wound-activated transformation of caulerpenyne by invasive and noninvasive *Caulerpa* species of the Mediterranean. *Journal of Chemical Ecology* 28: 2091-2105
- Levi F, Francour P (2004) Behavioural response of *Mullus surmuletus* to habitat modification by the invasive macroalga *Caulerpa taxifolia*. *Journal of Fish Biology* 64: 55-64
- Longepierre S, Robert A, Levi F, Francour P (2005) How an invasive alga species (*Caulerpa taxifolia*) induces changes in foraging strategies of the benthivorous fish *Mullus surmuletus* in coastal Mediterranean ecosystems. *Biodiversity and Conservation* 14: 365-376
- Mack RN, Simberloff D, Lonsdale WM, Evans H, Clout M, Bazzaz FA (2000) Biotic invasions: Causes, epidemiology, global consequences, and control. *Ecological Applications* 10: 689-710

- Meinesz A (1979) Contribution to the Study of *Caulerpa-Prolifera* (Forsskal) Lamouroux (Chlorophyceae, Caulerpales) .1. Morphogenesis and Growth at a Station Off the French Continental Coast of the Mediterranean Sea. *Botanica Marina* 22: 27-39
- Meinesz A (1997) The alga *taxifolia*'s implacable advance. *Recherche*: 46-48
- Meinesz A, Hesse B (1991) Introduction of the Tropical Alga *Caulerpa taxifolia* and Its Invasion of the Northwestern Mediterranean. *Oceanologica Acta* 14: 415-426
- Pandolfo A, Chemello R (1995) Prime nota sulla malacofauna associata a *Caulerpa racemosa* nella Baia di Santa Panagia (Sicilia orientale). *Biologia Marina Mediterranea* 2: 649-651
- Piazzì L, Balata D, Ceccherelli G, Cinelli F (2005) Interactive effect of sedimentation and *Caulerpa racemosa* var. *cylindracea* invasion on macroalgal assemblages in the Mediterranean Sea. *Estuarine Coastal and Shelf Science* 64: 467-474
- Piazzì L, Cinelli F (1999) Development and seasonal dynamics of a population of the tropical alga *Caulerpa racemosa* (Forsskal) J. Agardh in the Mediterranean. *Cryptogamie Algologie* 20: 295-300
- Garcia-Raso JE (1990) Study of a Crustacea-Decapoda Taxocenosis of *Posidonia oceanica* Beds from the Southeast of Spain. *Marine Ecology-Pubblicazioni Della Stazione Zoologica Di Napoli I* 11: 309-326
- Garcia-Raso JEG, delaRosa IL, Rosales JM (1996) Decapod crustacean communities from calcareous seaweed and *Posidonia oceanica* (rhizome stratum) in shallow waters. *Ophelia* 45: 143-158
- Sakai AK, Allendorf FW, Holt JS, Lodge DM, Molofsky J, With KA, Baughman S, Cabin RJ, Cohen JE, Ellstrand NC, McCauley DE, O'Neil P, Parker IM, Thompson JN, Weller SG (2001) The population biology of invasive species. *Annual Review of Ecology and Systematics* 32: 305-332
- Sanchez-Jerez P, Barbera-Cebrian C, Ramos-Espla AA (2000) Influence of the structure of *Posidonia oceanica* meadows modified by bottom trawling on crustacean assemblages: comparison of amphipods and decapods. *Scientia Marina* 64: 319-326
- Sanchez-Jerez P, Cebrian CB, Espla AAR (1999) Comparison of the epifauna spatial distribution in *Posidonia oceanica*, *Cymodocea nodosa* and unvegetated bottoms: Importance of meadow edges 20: 391-405

- Sanchez-Moyano JE, Estacio FJ, Garcia-Adiego EM, Garcia-Gomez JC (2001a) Effect of the vegetative cycle of *Caulerpa prolifera* on the spatio-temporal variation of invertebrate macrofauna. *Aquatic Botany* 70: 163-174
- Sanchez-Moyano JE, Garcia-Adiego EM, Estacio FJ, Garcia-Gomez JC (2001b) Influence of the density of *Caulerpa prolifera* (Chlorophyta) on the composition of the macrofauna in a meadow in Algeciras Bay (southern Spain). *Ciencias Marinas* 27: 47-71
- Sanchez-Moyano JE, Moreno D, Rueda JL, Garcia-Raso JE, Salas C, Gofas S (2004) Las praderas de *Caulerpa prolifera*. In: Ambiente CdM (ed) Praderas y bosques marinos de Andalucía. Junta de Andalucía, Sevilla, pp 239-249
- Sureda A, Box A, Ensenat M, Alou E, Tauler P, Deudero S, Pons A (2006) Enzymatic antioxidant response of a labrid fish (*Coris julis*) liver to environmental caulerpenyne. *Comparative Biochemistry and Physiology C-Toxicology & Pharmacology* 144: 191-196
- Templado J (1984) Las praderas de *Posidonia oceanica* en el sureste español y su biocenosis. In: Boudouresque CF, Jeudy De Grissac A, Olivier J (eds) 1st International Workshop on *Posidonia oceanica* beds. G.I.S Posidonie publications, France, pp 159-172
- Templado J, Ballesteros E, Garcia-Raso JE, San Martin GA, Lopez-Garcia L, Salas C, Luque A, Sanchez-Lizaso JL, Moreno D (2004) La comunidad posidonícola. In: Luque del Villar AA, Templado J (eds) Praderas y Bosques Marinos de Andalucía. Consejería de Medio Ambiente, Junta de Andalucía, Sevilla
- Terrados J, Ros J (1995) Temporal Variation of the Biomass and Structure of *Caulerpa Prolifera* (Forsskal) Lamouroux Meadows in the Mar Menor Lagoon (Se Spain). *Scientia Marina* 59: 49-56
- Thibaut T, Meinesz A, Coquillard P (2004) Biomass seasonality of *Caulerpa taxifolia* in the Mediterranean Sea. *Aquatic Botany* 80: 291-297
- Verlaque M, Durand C, Huisman JM, Boudouresque CF, Le Parco Y (2003) On the identity and origin of the Mediterranean invasive *Caulerpa racemosa* (Caulerpales, Chlorophyta). *European Journal of Phycology* 38: 325-339
- Waldbusser GG, Marinelli RL (2006) Macrofaunal modification of porewater advection: role of species function, species interaction, and kinetics. *Marine Ecology-Progress Series* 311: 217-231

Zariquiey R (1968) Crustáceos Decápodos Ibéricos. Consejo Superior de Investigaciones Científica, Patronato Juan de la Cierva, Barcelona

Zuljevic A, Antolic B, Onofri V (2003) First record of *Caulerpa racemosa* (Caulerpales : Chlorophyta) in the Adriatic Sea. Journal of the Marine Biological Association of the United Kingdom 83: 711-712

3.3 Resumen de las comunidades de decápodos

- En *Posidonia oceanica* la abundancia acumulada de decápodos a lo largo de 12 muestreos repartidos en 2 años es de 446 ejemplares pertenecientes a 19 especies. Los decápodos dominantes son *Athanas nitescens*, *Calcinus tubularis* y *Galathea bolivari*.
- En *Caulerpa prolifera* la abundancia acumulada es de 964 decápodos pertenecientes a 18 especies. Los decápodos dominantes son *Athanas nitescens*, *Calcinus tubularis* y *Xantho pilipes*.
- En *Caulerpa taxifolia* se obtuvo una abundancia acumulada de decápodos de 1175 ejemplares. En esta caulerpal se obtuvo el mayor número de especies, 19, de las cuales, las dominantes son *Athanas nitescens*, *Calcinus tubularis*, *Cestopagurus timidus*, *Ebalia edwardsii*
- La comunidad de decápodos asociada a *Caulerpa racemosa*, presenta una abundancia acumulada de 1175 ejemplares. La abundancia de decápodos es superior a los otros 3 hábitats estudiados. Fueron identificadas 17 especies de decápodos. Las especies dominantes son *Athanas nitescens*, *Galathea bolivari* y *Cestopagurus timidus*.
- Tanto la abundancia de decápodos en *Caulerpa racemosa*, como la diversidad de decápodos en *C. taxifolia* es significativamente superior que en *Posidonia oceanica*.
- *Caulerpa prolifera* no muestra diferencias respecto a las invasoras ni a *Posidonia oceanica* en lo referente a abundancias y diversidad de especies de decápodos.
- La composición específica de la endofauna de decápodos muestreada presenta una elevada coincidencia de decápodos en las tres especies de *Caulerpa* y *Posidonia oceanica*. Las principales diferencias entre los hábitats están en la

abundancia de las especies coincidentes, generalmente mayores en *Caulerpa* spp., como *Calcinus tubularis*, *Cestopagurus timidus*, *Athanas nitescens*, *Alpheus dentipes* y *Galathea bolivari*.

- En las zonas colonizadas por *Caulerpa* spp. destacan por su abundancia especies excavadoras como *Athanas nitescens*, *Alpheus dentipes* y *Galathea bolivari*. Éstas contribuyen de forma importante a diferenciar la comunidad de decápodos entre *Caulerpa* spp y *Posidonia oceanica*. De acuerdo con Borg *et al* (2006) la mata muerta es un sustrato que favorece los organismos excavadores gracias a la gran cantidad de huecos y espacios que se generan al desaparecer el estrato folial de *P. oceanica*.
- El decápodo excavador *Upogebia mediterranea* también contribuye en la diferenciación de *Caulerpa racemosa* var. *cylindracea* y *C. prolifera* de *Posidonia oceanica* donde presenta menores abundancias.
- La introducción de las especies de *Caulerpa* invasoras conlleva un aumento en las abundancias y diversidad de decápodos. Esto puede ser debido a varios factores: la presencia de mata muerta de *Posidonia oceanica* (Borg *et al*, 2006), el hábitat generado por los frondes y estolones de *Caulerpa* spp, el efecto barrera de las estructuras de *Caulerpa* sobre los peces (Longepierre *et al*. 2005) y las migraciones horizontales de muchos decápodos desde la *Posidonia oceanica* hacia las caulerpales en busca tanto de refugio como de alimento.
- Las correlaciones entre los componentes estructurales de la muestra y las principales especies de decápodos no muestran un patrón coincidente entre los hábitats. A pesar de ello la granulometría afecta a la abundancia de *Athanas nitescens*, *Galathea bolivari* y *Upogebia mediterranea*. Los componentes estructurales de *P. oceanica* están relacionados con la abundancia de *A. nitescens*, *Cestopagurus timidus* y *G. squamifera*. El efecto de la biomasa de *Caulerpa* spp, solo queda patente en *C. prolifera* y en el decápodo *Calcinus tubularis*, cuya densidad se ve aumentada al aumentar la biomasa.

Capítulo 4

CAMBIOS EN LAS COMUNIDADES DE POLIQUETOS CHANGES IN POLYCHAETA COMMUNITIES

Capítulo adaptado de:

Seagrass polychaete assemblages changes after invasion by *Caulerpa racemosa* var *cylindracea*: community structure and trophic guilds . Box, A., Martín, D., Deudero., S. In prep

Seagrass polychaete assemblages differences between invasive *Caulerpa taxifolia* and established *C. prolifera*: community structure and trophic guilds. Box, A., Martín, D., Deudero, S. In Prep

4.1 Introducción al capítulo

El presente capítulo se analizan los resultados obtenidos referentes a abundancia, diversidad, estacionalidad y estrategias tróficas de poliquetos en *Posidonia oceanica*, *Caulerpa racemosa* var. *cylindracea*, *Caulerpa taxifolia* y *Caulerpa prolifera*.

Los poliquetos constituyen una clase del fílum annelida. Éste se puede dividir en dos grupos, aquellos con mayor capacidad de desplazamiento, llamados errantes, y los que acostumbran a construir tubos o túneles con escaso o nulo desplazamiento, llamados sedentarios. La diferente capacidad de retener partículas de cada una de las algas, junto con su diferente estacionalidad afectará de modo diferente a las especies de poliquetos tras el cambio en la cobertura vegetada en el hábitat.

Entre los invertebrados bentónicos, los poliquetos constituyen uno de los principales grupos en la estructura de las comunidades, destacándose su importancia como descriptores de la comunidad de *Posidonia oceanica* (Gambi et al. 1995). A pesar que las praderas de *P. oceanica* carecen de especies propias, la comunidad de poliquetos en esta fanerógama es muy característica con gran presencia de ejemplares de la familia Syllinae (Gambi et al. 1998). El estrato foliar, está caracterizado por presentar menor número de especies y diversidad, y el estrato rizomático es más diverso y con mayores abundancias de poliquetos (Gambi et al. 1995).

En el primer trabajo expuesto en este capítulo se analizan las diferencias referentes a la composición específica, abundancia, número de especies y diversidad de los poliquetos muestreados a lo largo del periodo 2004-2005, correspondientes a una pradera de *Posidonia oceanica* invadida por *C. racemosa* var. *cylindracea* y una pradera de *P. oceanica* no invadida.

Las muestras analizadas en el presente trabajo se han recogido mediante un cuadrante 20 x 20 cm insertado 5 cm en el sustrato durante el periodo de febrero 2004 hasta febrero 2005. Dentro de estas muestras se han separado, entre otros fílums, los poliquetos de los cuales se han analizado su composición específica, abundancia y variación estacional.

En el segundo trabajo del presente capítulo se analizan y comparan las especies y abundancias de poliquetos de una pradera de *Caulerpa prolifera* y *C. taxifolia*. La comunidad de poliquetos en *C. prolifera* ha sido estudiada por Sanchez-Moyano 2001 a,b. La comunidad de poliquetos de *C. taxifolia* no ha sido estudiada hasta el momento

por lo que los resultados de este trabajo suponen una primera aproximación a la fauna de *C. taxifolia* en el Mediterráneo.

Las muestras analizadas en este trabajo abarcan desde marzo del 2003 hasta febrero del 2005. Las muestras se han obtenido siguiendo el mismo proceso que en el primer caso. Dentro de cada muestra se han separado los poliquetos, para los cuales se han analizado su composición específica, abundancias, variación estacional y estrategias tróficas.

En ambos trabajos se ha considerado la contribución de las diferentes estructuras de *Posidonia oceanica* (hojas, raíces, rizomas y vainas), la biomasa de *Caulerpa* spp. y las granulometrías del sustrato para establecer las diferencia entre las comunidades de poliquetos propias de los hábitats estudiados.

La clasificación taxonómica se ha realizado mediante la consulta de las obras “Faune de France 5, Polychètes Errantes” ,“Faune de France 16, Polychètes Sédentaires” (Fauvel 1923; Fauvel 1927), “Fauna de España, Fauna de Anélidos Poliquetos de la Península Ibérica” (Campoy 1982), “Policheti Serpuloidei” (Bianchi 1981), “A Systematic Revision of the Sabellidae-Caobangiidae-Sabellongidae Complex (Annelida: Polychaeta)” (Fitzhugh 1989), “Maldanidae (Annelida: Polychaete) from Japan (Part 1)” (Imajima 1982), “The Aphroditoidea (Annelida: Polychaeta) of the Mediterranean Sea (Barnich and Fiege 2003) y la gran obra “Fauna Iberica, Annelida Polychaeta II, Syllidae” “Fauna Iberica, Annelida Polychaeta I” (San Martin 2003; Viétez et al. 2004), entre otras publicaciones científicas.

4.2 Seagrass polychaete assemblages changes after invasion by *Caulerpa racemosa* var. *cylindracea*: community structure and trophic guilds

Abstract

The regression of the *Posidonia oceanica* seagrass meadows altogether with the colonisation of rhizomes by invasive *Caulerpa racemosa* in the Balearic Islands produces important changes in the ecosystem functioning, which affect the benthic faunal communities. Polychaete assemblages were studied out along two years to describe the populations associated to *Posidonia oceanica* meadows invaded by *C. racemosa*. Higher abundances and number of species were found from August to December (e.g. 358 ind/m² and 20 species in October) and the abundance, number of species and diversity of polychaetes were positively correlated with *C. racemosa* biomass. Therefore, the spatial complexity provided by the frond and stolon net of *C. racemosa* seems to combine with that of the remaining seagrass matt allowing to support a well-developed polychaete assemblage. Compared to a closer, living *P. oceanica* meadow (where the maximum abundances and number of species occurred from February to June), the invaded meadows harboured significantly modified polychaete assemblages. However, the major impacts seemed to be non-harmful (i.e. increasing abundance and number of species) and affected the seasonality of the assemblages, in coincidence with the fluctuations of the *C. racemosa* biomass.

Keywords: *Posidonia oceanica*, *Caulerpa racemosa*, polychaete, diversity, trophic guilds, Mediterranean.

Introduction

The presence of alien species in the Mediterranean, currently about 662 (Gollasch 2006), is an increasing problem that still needs to be studied to clarify its consequences. Invasive species are considered a serious threat to natural ecosystems (Mack et al. 2000), as well as one of the major drivers of biodiversity loss (Sakai et al. 2001). Invaders could be highly competitive and their interaction with native species can cause a global decrease of biodiversity (Bax et al. 2003). Negative effects of invasive species over the local biota have been recently reported, especially for macroalgal communities (Piazzi & Cinelli 2000; Meinesz et al. 2001; Balata et al. 2004; Meinesz 2004).

In the Mediterranean Sea, 84 introduced macrophytes have been cited to date (Boudouresque & Verlaque 2002). Two of them belong to the green algae genus *Caulerpa*: *C. taxifolia* and *C. racemosa* (Ceccherelli et al. 2002). Its presence induces drastic changes in faunistic composition and abundance of the affected systems, thus becoming a serious problem in the Western Mediterranean (Pandolfo & Chemello 1995, Bellan-Santini et al. 1996, Argyrou et al. 1999, Buia et al. 2001). The species of *Caulerpa* produce anti-herbivorous secondary metabolites (Amade & Lemee 1998, Jung et al. 2002), such as caulerpenyne, the major one, which affects negatively the grazing organisms (Boudouresque et al. 1996, Parent Massin et al. 1996, Pesando et al. 1996, Amade & Lemee 1998, Pesando et al. 1998, Sureda et al. 2006) and changes chemically the environmental conditions of the habitat (Amade & Lemee 1998, Sureda et al. 2006).

Posidonia oceanica (L.) Delile meadows are among the most important Mediterranean ecosystems, with an estimated extension between 2.5 - 5.5 million hectares (Buia et al. 2000). *Posidonia* beds are characterized by their foliar canopy and root-rhizome layer, which strongly influenced the associated fauna (Buia et al. 2000, Borg et al. 2006). Even dead (i.e. after losing the foliar structures), *Posidonia* beds still support a rich macrofauna in terms of number of species and diversity (Borg et al. 2006). However, the particular characteristics of *P. oceanica* meadows make them highly sensible to competitors, such as the invasive species of the genus *Caulerpa* (Ceccherelli et al. 2002).

The substitution of local species by invaders is nowadays a worldwide phenomenon (Montefalcone et al. 2007), and the Mediterranean *Posidonia* meadows are not an exception. Our study focuses on one of its competitors particularly, the invading

Caulerpa racemosa, which has already been reported from 11 Mediterranean countries: Albania, Croatia, France, Greece, Italy, Libya, Malta, Spain, Tunisia and Turkey (Verlaque et al. 2003). *Caulerpa racemosa* spreads in sheltered and exposed areas, colonising all kind of substrates from 0 to 70 m deep (Argyrou et al. 1999, Piazzzi & Cinelli 1999, Zuljevic et al. 2003). Introduced species often become more invasive in impacted ecosystems. For instance, the brown alga *Sargassum muticum* substitutes *Zostera marina* in damaged beds of the French Atlantic coast (Givernaud et al. 1991) or the green alga *Enteromorpha radiata*, which spreads in deteriorated mixed beds of *Zostera noltii* and *Z. marina* in Great Britain coasts (Den Hartog 1994). In particular, regressive *Posidonia oceanica* meadows are more prone to be invaded by *C. racemosa* var *cylindracea* than healthy ones (Ceccherelli et al. 2000).

The invertebrate assemblages, including those associated to seagrass beds, may also be affected by the presence of invasive species, which may either enhance (Argyrou 1999; Antoniadou & Chintiroglou 2007) or decrease (Galil & Zenetos 2002; Zenetos et al 2003; Streftaris & Zenetos 2006) its diversity. Among benthic invertebrates, the polychaetes are considered as excellent descriptors of the structure of faunal assemblages, including those in association with seagrasses (Gambi et al. 1998, Brito et al. 2005). Although *Posidonia oceanica* beds lack exclusive polychaete species, the structure of their assemblages is very characteristic and tends to differ between the leaf stratum and the rhizomes and “matte”, the former being less abundant and diverse and the latter having, in general, no dominant species but a high richness with relative low abundances per species (Gambi et al. 1995).

Previous studies showed an increase of soft-bottom polychaete diversity and abundance in association with the presence of *Caulerpa racemosa* (Argyrou et al. 1999). However, in the Balearic Islands, *C. racemosa* has only been found overgrowing dead *Posidonia* meadows. Therefore, the aim of our study was to describe the structure (both in terms of species and trophic diversity) and the seasonal patterns of the polychaete assemblages associated to dead *Posidonia oceanica* meadows invaded by *C. racemosa* and to compare the m with those associated to living *Posidonia* meadows.

Material and methods

Study area

The study was carried out in Mallorca Island (Balearic Islands, Western Mediterranean), where *Caulerpa racemosa* var. *cylindracea* overgrowing dead *Posidonia* meadows forms patches that are surrounded by sandy bottoms and living seagrass meadows. Samples (hereafter called *Caulerpa* mats) were collected in an enclosed bay (Portals Vells Bay, Southwest Mallorca, N 39° 28.321' / E 2° 31.320', 5 – 8 m deep). For the comparisons, samples of living *Posidonia oceanica* (hereafter called *Posidonia* meadows) were collected in a similar enclosed bay (Cala D'Or Bay, Southeast Mallorca, N 39° 22.164' / E 3° 13.887' and N 39° 22.028', 5 -8 m deep), which was not invaded by *Caulerpa*.

Sampling

From February 2004 to February 2005, *Caulerpa* mats and *Posidonia* meadows were sampled bimonthly. Three replicate samples (per meadow and sampling date) of a 20 x 20 cm frame were collected by SCUBA diving in the morning (10h - 12h GTM). The frame was inserted 5 cm into the sediment. Samples were placed in a plastic mesh bag of 0.5 mm pore size, fixed in formaldehyde 4 %, preserved in 70 % ethanol and then sorted out in the laboratory. *Caulerpa racemosa* was sorted and dry-weighted (24 h at 60 °C), as well as the rhizomes, roots and sheaths of the dead *Posidonia* mat. For the living *Posidonia* meadows, leaves were also sorted out dry-weighted (24 h at 60 °C). All their respective biomasses were expressed as percentages.

The polychaete specimens were sorted under a stereomicroscope, identified at the lowest taxonomic level possible, and then grouped into trophic guilds: carnivorous, herbivorous, omnivorous, deposit feeders and filter feeders (according Fauchald & Jumars 1979, Gambi et al. 1995, Martin et al. 2000, Antoniadou & Chintiroglou 2006). For statistical purposes, the species of Paraonidae, Capitellidae, Sabellidae and Maldanidae were pooled at family level, due the misidentification of several individuals. A species was considered as dominant when its abundance was more than 1% of the total.

In parallel with macrobenthic samples, three corers per meadow and sampling date (inserted 5 cm into the sediment) were collected to characterize the granulometry. After eliminating organic matter using H₂O₂, the sediment was dried for 24 h and the grain size fractions were established following classic Wentworth (1972) scale.

Statistical analysis

In order to characterize the polychaete assemblages associated to *Caulerpa* mats, their different structures (i.e., *Caulerpa* network and *Posidonia* rhizomes, sheaths, dead leaves and roots) were taken into account. In *Posidonia* meadows, living leaves were also considered. In the comparisons between *Caulerpa* mats and *Posidonia* meadows, the differences in the polychaete assemblages harboured by these structures were tested by two-way analysis of variance (two-way ANOVA) including time as factor.

The structure of the polychaete assemblages was analyzed using PRIMER 5.0 software (Clarke 1993, Clarke and Warwick, 1994). A CLUSTER analysis was performed on a resemblance matrix (Bray-Curtis index) estimated from a fourth-root transformed abundance per sample (replicates samples pooled by meadow and sampling date) matrix. No reduction in species was applied. The Multidimensional Scaling (MDS) routine was used for a two-dimensional representation. The ANOSIM routine (Clarke and Warwick 1994) was applied to assess the differences between the groups obtained in the CLUSTER analysis. The polychaete species responsible for the observed differences were identified by means of the SIMPER routine and the DIVERSE routine was used to obtain the following descriptors of the polychaete assemblages: density, number of species per sample, the diversity index and evenness (Clarke and Warwick 1994). Pairwise correlations (Pearson test) were performed to assess the relationships between *C. racemosa* biomass and the descriptors of the polychaete assemblages, as well as with the trophic groups. One-way ANOVA (factor meadow) was performed to test changes in the main trophic guilds between meadows. The most characteristic polychaete species (i.e., with a higher contribution according to the SIMPER routine) were used to analyse the seasonal trends of the assemblages by means of a two-way ANOVA (factors meadow and time).

Sample characterization

The sheath fraction was significantly predominant both in *Caulerpa* mats and *Posidonia* meadows, while roots and living leaves were the second main fractions, respectively (Fig 1 A). In *Caulerpa* mats, however, there was a significant seasonal effect, as the maximum biomasses of the algae occurred between August and December, being highly influenced by the warm 2004 end (Fig. 2).

The sediments associated to *Caulerpa* mats presented an inter-annual variability in grain size, with a predominance of medium sands (500 μm) in 2003 and fine sands (250 μm) in 2004 (Fig. 1B). Conversely, in *Posidonia* meadows there was an overall predominance of fine sands (Fig. 1B).

Faunistic composition

A total of 1863 polychaete individuals belonging to 43 taxa were identified in *Caulerpa* mats. Nereididae and Sigalionidae were the most abundant families throughout the year. The species richness was high, with 25 species being dominant through the year. The most abundant species were *Neanthes agulhana*, *Pelogenia arenosa*, *Polyopthalmus pictus* and *Lumbrineris latreilli* (Table 1). *Neanthes agulhana* was present in all sampled periods, while *P. arenosa*, *P. pictus*, *Arabella iricolor* and *Sthenelais boa* showed frequencies over 70% (Table 1). The internal similarity of the polychaete assemblages from the *Caulerpa* mat was 32.57% and the taxa with higher contributions ($\geq 80\%$) were *N. agulhana*, *P. arenosa*, *P. pictus*, Capitellidae, *A. iricolor*, *L. latreilli*, *S. boa*, *Harmothoe spinifera*, *Pholoe inornata*, *Pontogenia chrysocoma* and *Syllis garciai*.

On the other hand, 1475 polychaete specimens belonging to 44 taxa were identified in the *Posidonia* meadows. Eunicidae and Nereididae were the most abundant families throughout the year. There was a high species richness, with 29 dominant species. The most abundant were *Nematonereis unicornis*, *Aponuphis bilineata* and *Neanthes agulhana* (Table 2). Three species showed frequencies over 70%: *Lumbrineris gracilis*, *Aponuphis bilineata* and *N. agulhana* (Table 2). The internal similarity of the polychaete assemblages from the *Posidonia* meadow was 25.01% and the taxa with higher contribution ($\geq 80\%$) were Capitellidae, *A. bilineata*, *L. gracilis*, *N. agulhana*, *N.*

unicornis, Maldanidae, *Polyopthalmus pictus*, *Eunice vittata*, *Lumbrineris latreilli* and Terebellidae.

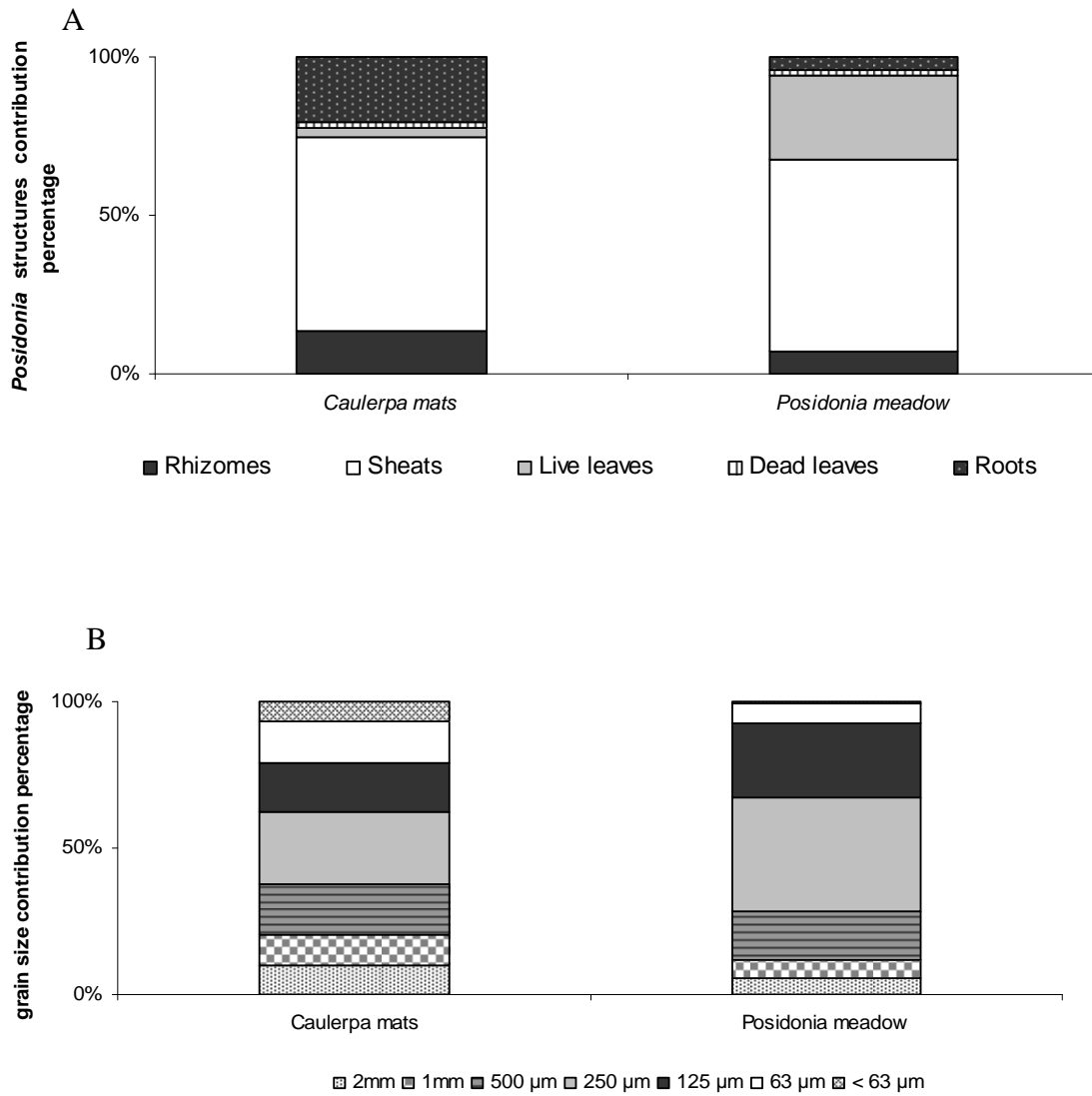

Figure 1: *Caulerpa* mats and *Posidonia* meadows annual means of. A: Biomass of the *Posidonia oceanica* fractions (as percentage in weight), B: granulometry.

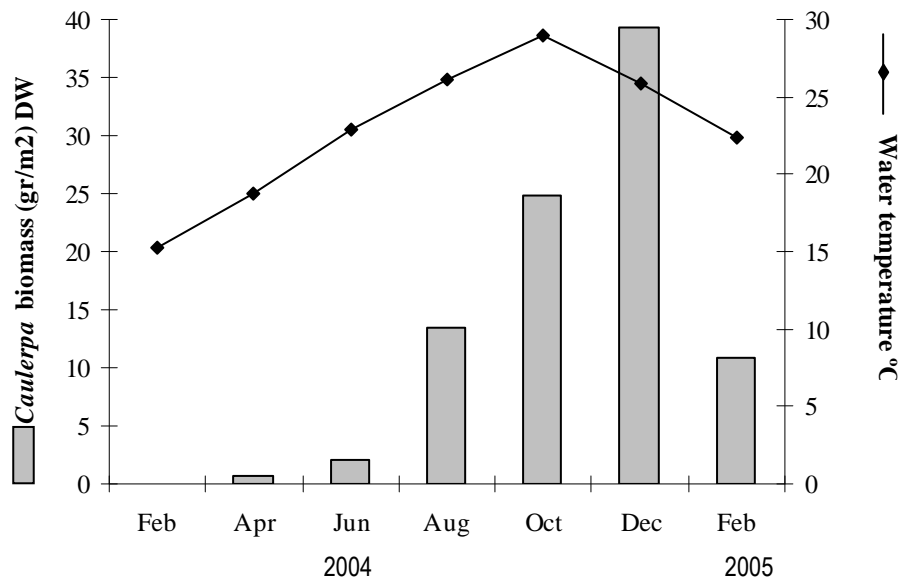

Figure 2: Seasonal patterns in *Caulerpa racemosa* biomass and water temperature.

The structure of the polychaete assemblage showed seasonal differences (Fig. 3). At 60% of similarity, there was a cluster of *Caulerpa* mat samples corresponding to those (i.e. August, October and December) with higher algal biomass (Group 1). Then, at 40% of similarity, all remaining *Caulerpa* mat samples (except February 2005) joined successively Group 1 (forming Group 1B). The February 2005 sample, in turn, was clustered with the October 2004 *Posidonia* meadow (Group 2). Group 3 included late winter, spring and early summer *Posidonia* meadow from 2004, while both the 2004 and 2005 winter ones formed Group 4. Finally, the single summer *Posidonia* meadow sample remained isolated (Group 5).

Table 1: Seasonal changes in the *Caulerpa racemosa* polychaeta expressed as individuals/m² sampled in Cala d'Or. Frequency = n° samples with presence/ total n° seasonal samples). Dominance = total number of specie individuals / total polychaeta number (expressed as percentage)

Taxa	CRFEB04	CRAPR04	CRJUN04	CRAUG04	CROCT04	CRDEC04	CRFEB05	Total	Standard	Frequency	Dominance
								Number	Error		
<i>Neanthes agulhana</i>	17±8.33	25±14.44	25±24.01	8±8.33	58±8.33	25±14.44	8±8.33	167	9.00	100.00	8.94
<i>Pelogenia arenosa</i>	17±8.33		8±8.33	17±8.33	8±8.33	42±41.01	42±30.04	133	8.40	85.71	7.16
<i>Polyophthalmus pictus</i>	25±14.44	33±8.33	42±22.05	17±8.33	8±8.33	8±8.33		133	8.40	85.71	7.16
<i>Capitellidae</i>		17±16.33		25±16.66	8±8.33	58±22	17±16.67	125	9.45	71.43	6.71
<i>Lumbrineris latreilli</i>	42±41.67				33±16.67	33±8.33	8±8.33	117	11.02	57.14	6.26
<i>Harmothoe spinifera</i>			17±25.00	8±8.33	42±22.05	25±25.00		92	8.66	57.14	4.92
<i>Arabella iricolor</i>	8±8.33	17±16.67	8±8.33	25±25	8±8.33	17±8.33		83	5.23	85.71	4.45
<i>Sthenelais boa</i>	17±8.33		8±8.33	8±8.33	25±14.43	17±16.67		75	5.67	71.43	4.03
<i>Syllis garciai</i>	8±8.33	42±41.66		17±16.67		8±8.33		75	7.09	57.14	4.03
<i>Pontogenia chrysocoma</i>		25±25.00	8±8.33	17±16.67	17±8.33			67	6.30	57.14	3.58
<i>Pherusa eruca</i>		17±8.33		33	8±8.33			58	7.35	42.86	3.13
<i>Pholoe inornata</i>		17±16.67	17±16.67	8±8.33		17±16.67		58	5.51	57.14	3.13
<i>Platynereis dumerilii</i>	8±8.33			17±8.33	25±14.44			50	6.30	42.86	2.68
<i>Lumbrineris gracilis</i>					42±30.05		8±8.33	50	9.45	28.57	2.68
<i>Maldanidae</i>				17±16.67	17±16.67	17±16.67		50	6.30	42.86	2.68
<i>Pectinaria (Lagis) koremi</i>			17±8.33	8±8.33	8±8.33	8±8.33		42	3.94	57.14	2.24
<i>Hyalinoecia bilineata</i>	17±16.67	8±8.33			8±8.33	8±8.33		42	3.94	57.14	2.24
<i>Neanthes caudata</i>	8±8.33	17±16.67				17±16.67		42	5.25	42.86	2.24
<i>Sphaerosyllis pirifera</i>		25±14.44			8±8.33	8±8.33		42	5.25	42.86	2.24
<i>Spirobranchus polytrema</i>			25±25.00					25	9.45	14.29	1.34
<i>Haplosyllis spongicola</i>			17±16.67			8±8.33		25	4.72	28.57	1.34
<i>Malmgreniella lunulata</i>					8±8.33	17±8.33		25	4.72	28.57	1.34
<i>Pectinaria(Amphictene) auricoma</i>	8±8.33				17±16.67			25	4.72	28.57	1.34
<i>Paraonidae</i>		8±8.33			8±8.33	8±8.33		25	3.15	42.86	1.34

<i>Eunice vittata</i>			8±8.33	8±8.33	8±8.33	24	3.07	42.86	1.31
<i>Syllis variegata</i>	17±16.67					17	6.30	14.29	0.89
<i>Vermiliopsis striaticeps</i>		17±16.67				17	6.30	14.29	0.89
<i>Harmothoe sp.</i>	8±8.33	8±8.33				17	3.15	28.57	0.89
<i>Glycera sp.</i>				8±8.33	8±8.33	17	3.15	28.57	0.89
<i>Parapionosyllis brevecirra</i>					17±16.67	17	6.30	14.29	0.89
<i>Fimbriosthenelais minor</i>		8±8.33			8±8.33	16	3.02	28.57	0.86
<i>Chrysopetalum debile</i>	8±8.33				8±8.33	16	3.02	28.57	0.86
<i>Terebellidae</i>			8±8.33			8	3.15	14.29	0.45
<i>Syllis gerlachi</i>		8±8.33				8	3.15	14.29	0.45
<i>Syllis westheidei</i>		8±8.33				8	3.15	14.29	0.45
<i>Schistomeringos rudolphi</i>		8±8.33				8	3.15	14.29	0.45
<i>Sabellidae</i>						8	3.15	14.29	0.45
<i>Lumbrineropsis paradoxa</i>						8	3.15	14.29	0.45
<i>Sphaerosyllis austriaca</i>						8	3.15	14.29	0.45
<i>Lysidice ninetta</i>			8±8.33			8	3.15	14.29	0.45
<i>Nematoneis unicornis</i>				8±8.33		8	3.15	14.29	0.45
<i>Exogone (exogone) dispar</i>		8±8.33				8	3.02	14.29	0.43
<i>Exogone (exogone) rostrata</i>		8±8.33				8	3.02	14.29	0.43
<i>Cirratulidae</i>					8±8.33	8	3.02	14.29	0.43

Table 2: Seasonal changes in the *Posidonia oceanica* polychaeta expressed as individuals/m² sampled in Cala d'Or. Frequency = n° samples with presence/ total n° seasonal samples). Dominance = total number of specie individuals / total polychaeta number (expressed as percentage)

	POFEB04	POAPR04	POJUN04	POAUG04	POOCT04	PODEC04	POFEB05	Total Number	Standard Error	Frequency	Dominance
Capitellidae	50±14.44	33±22.05	33±22.05		17±16.67		8±8.33	141	17.76	71.43	9.68
<i>Nematonereis unicornis</i>	33±22.05		33±8.33			42±8.33	8±8.33	116	14.61	57.14	7.96
<i>Hyalinoecia bilineata</i>	17±8.33	8±8.33			33±8.33	17±8.33	25±14.45	100	12.60	71.43	6.86
Maldanidae	17±8.33	42±30.04				8±8.33	25±8.33	92	11.59	57.14	6.31
<i>Neanthes agulhana</i>	25±0.00	25±14.43	25±14.43	8±8.33	8±8.33			91	11.46	71.43	6.25
<i>Lysidice ninetta</i>	58±30.05		8±8.33		17±8.33			83	10.46	42.86	5.70
Paraonidae	8±8.33					50±50	25±14.43	83	10.46	42.86	5.70
<i>Eunice vittata</i>	42±8.33	8±8.33	17±8.33			8±8.33		75	9.45	57.14	5.15
Terebellidae	33±22.05		17±16.67		17±16.67			67	8.44	42.86	4.60
<i>Lumbrineris gracilis</i>	17±16.67	17±8.33	8±8.33	8±8.33		8±8.33	8±8.33	66	8.32	85.71	4.53
<i>Polyopthalmus pictus</i>	17±8.33	8±8.33	8±8.33				25±14.44	58	7.31	57.14	3.98
<i>Lumbrineris latreilli</i>					17±8.33	17±16.67	8±8.33	42	5.29	42.86	2.88
<i>Platynereis dumerilii</i>	25±14.44		8±8.33			8±8.33		41	5.17	42.86	2.81
<i>Hydroides nigra</i>			17±16.67			17±16.67		34	4.28	28.57	2.33
Sabellidae	8±8.33						25±14.44	33	4.16	28.57	2.26
<i>Pterocirrus macroceros</i>				25±14.44				25	3.15	14.29	1.72
<i>Syllis variegata</i>	17±8.33		8±8.33					25	3.15	28.57	1.72
<i>Arabella iricolor</i>	8±8.33	17±8.33						25	3.15	28.57	1.72
Cirratulidae	8±8.33		8±8.33		8±8.33			24	3.02	42.86	1.65
<i>Chrysopetalum debile</i>			8±8.33	8±8.33			8±8.33	24	3.02	42.86	1.65
<i>Spirobranchus polytrema</i>			17±16.67					17	2.14	14.29	1.17
<i>Phyllodoce (Anaitides) mucosa</i>		17±16.67						17	2.14	14.29	1.17
<i>Pelogenia arenosa</i>						17±16.67		17	2.14	14.29	1.17
<i>Neanthes caudata</i>			17±16.67					17	2.14	14.29	1.17
<i>Syllis gerlachi</i>	8±8.33		8±8.33					16	2.02	28.57	1.10
<i>Sthenelais boa</i>			8±8.33			8±8.33		16	2.02	28.57	1.10
<i>Pherusa eruca</i>	8±8.33	8±8.33						16	2.02	28.57	1.10
<i>Glycera sp.</i>		8±8.33			8±8.33			16	2.02	28.57	1.10

<i>Haplosyllis spongicola</i>		8±8.33	8±8.33		16	2.02	28.57	1.10
<i>Sphaerosyllis pirifera</i>				8±8.33	8	1.01	14.29	0.55
<i>Pectinaria (Lagis) koremi</i>	8±8.33				8	1.01	14.29	0.55
<i>Syllis garciai</i>				8±8.33	8	1.01	14.29	0.55
<i>Schistomeringos rudolphi</i>				8±8.33	8	1.01	14.29	0.55
<i>Pontogenia chrysocoma</i>			8±8.33		8	1.01	14.29	0.55
<i>Lumbrineropsis paradoxa</i>			8±8.33		8	1.01	14.29	0.55
<i>Lumbrineris impatiens</i>	8±8.33				8	1.01	14.29	0.55
<i>Harmothoe sp.</i>		8±8.33			8	1.01	14.29	0.55
<i>Eunice harassii</i>	8±8.33				8	1.01	14.29	0.00

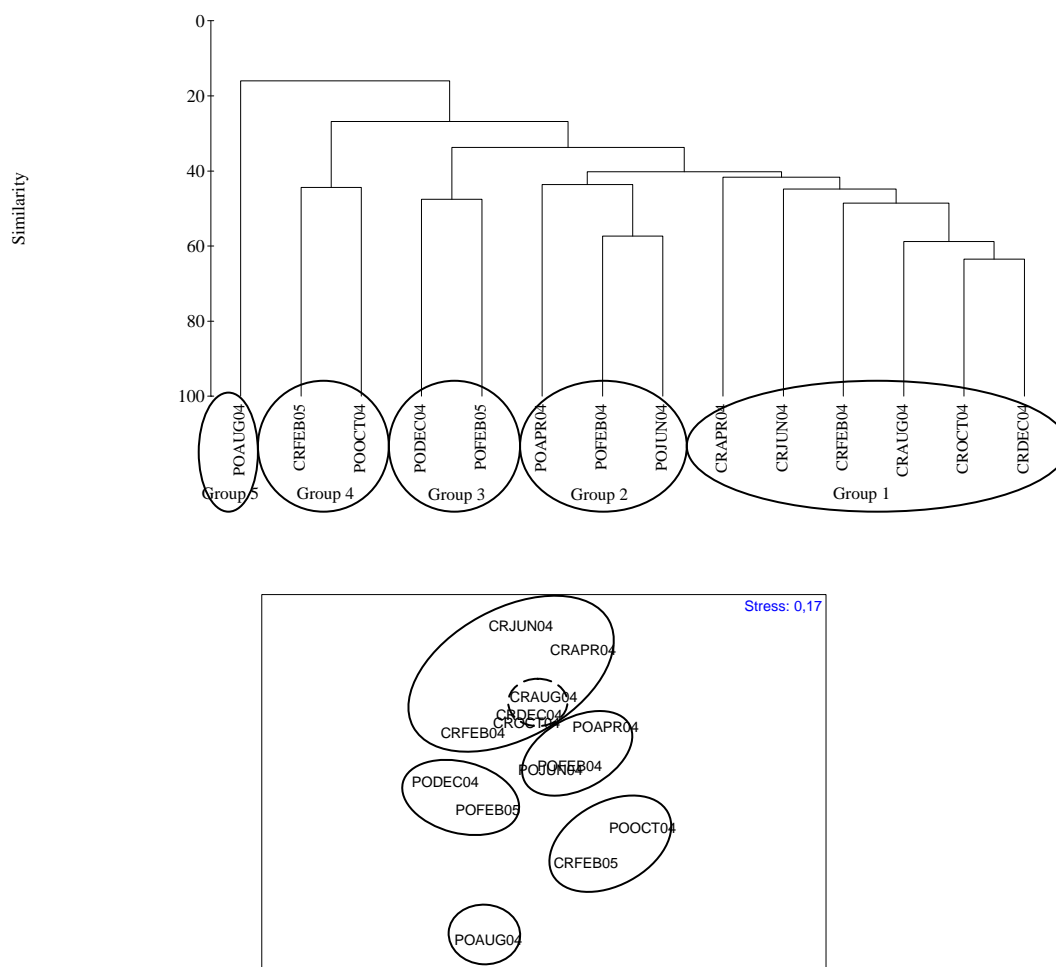

Fig 3: Cluster and MDS representation of polychaete assemblages of *Caulerpa racemosa* var *cylindracea* and *Posidonia oceanica*.

The ANOSIM revealed significant differences among the clustered groups (global $R = 0.769$, number of used permutations = 20.000, significance level = 0.1%) (Table 3). The SIMPER analysis results showed that that dissimilarity between the *Caulerpa* mat samples from group 1 and the *Posidonia* meadow samples (other groups) were mainly caused by *Polyapthalmus pictus*, *Neanthes agulhana*, *Lumbrineis latreilli* and Capitellidae (Table 3).

In *Caulerpa* mats, the maximum densities and highest number of species occurred in October, while the maximum diversities and evenness corresponded to August – December and august, respectively. Accordingly, the biomass of *Caulerpa racemosa* was positively correlated with density, number of species and diversity ($r = 0.839$, $r = 0.907$ and $r = 0.868$; $p = 0.05$). Conversely, in *Posidonia* meadows, the maximum densities, number of species and diversity occurred in February 2004, while maximum evenness was also in August (Fig. 4). No correlations were found between

polychaete descriptors and *Posidonia oceanica* fractions biomass in both *Caulerpa* mats and *Posidonia* meadow.

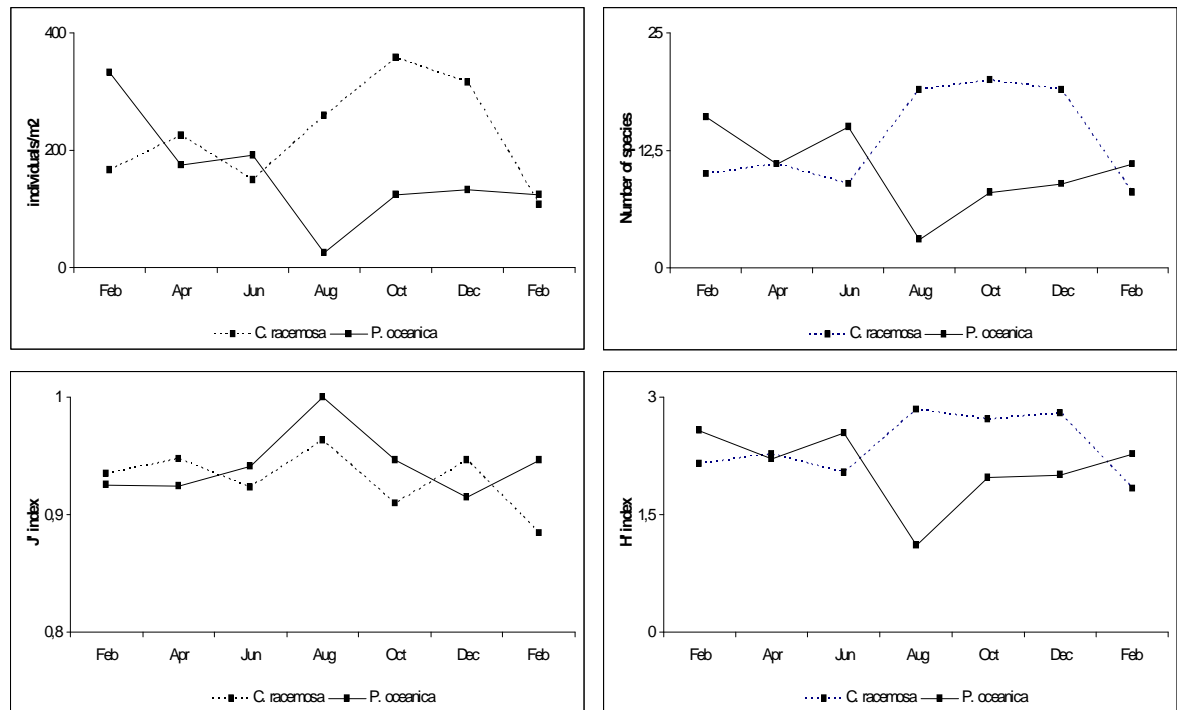

Figure 4: Total polychaeta abundances square meter and number of species (N), Jaccard index (J) and Shannon-Weaver index (H') in *Posidonia oceanica* and *Caulerpa racemosa* with seasonal changes.

The analysis of the main species in *Caulerpa* mats and *Posidonia* meadow show that there were significant differences in the abundances of several polychaete species such as *Harmothoe spinifera*, *Lumbrineris latreilli*, *Lysidice ninetta*, *Neanthes agulhana*, *Pelogenia arenosa* among others (Table 4)

Table 3: ANOSIM and SIMPER analysis between groups established after Cluster analysis.

GROUPS	ANOSIM		Average Dissimilarity	SIMPER
	R statistic	Sig level %		Most contributing species (to reach 60% dissimilarity)
Group 1-2	0.432	1.2	67.81	Capitellidae, <i>N. unicornis</i> , Maldanidae, <i>Lysidice ninetta</i> , <i>L. latreilli</i> , <i>E. vittata</i> , <i>L. gracilis</i> , <i>P. arenosa</i> , Terebellidae, <i>P. pictus</i> , <i>H. spinifera</i> , <i>S. garciai</i> , <i>P. dumerlii</i> , <i>S. boa</i> , <i>P. eruca</i>
Group 1-3	0.646	3.6	76.35	Paraonidae, <i>N. agulhana</i> , <i>N. unicornis</i> , <i>L. Latreilli</i> , <i>P. pictus</i> , Capitellidae, <i>H. bilineata</i> , <i>H. spinifera</i> , <i>A. iricolor</i> , Maldanidae, Sabellidae, <i>P. arenosa</i> , <i>L. gracilis</i> , <i>S. garciai</i> .
Group 1-4	1	3.6	81.21	<i>P. pictus</i> , <i>P. arenosa</i> , <i>L. latreilli</i> , <i>H. bilineata</i> , <i>N. agulhana</i> , Capitellidae, <i>A. iricolor</i> , <i>H. spinifera</i> , <i>S. garciai</i> , <i>S. boa</i> , <i>P. chrysocoma</i> , <i>P. eruca</i> , <i>P. inornata</i> , <i>L. gracilis</i> .
Group 1-5	1	14.3	92.50	<i>P. macroceros</i> , <i>P. Pictus</i> , <i>L. latreilli</i> , <i>N. agulhana</i> , Capitellidae, <i>N. agulhana</i> , Capitellidae, <i>P. arenosa</i> , <i>A. iricolor</i> , <i>H. spinifera</i> , <i>S. garciai</i> , <i>S. boa</i> , <i>L. gracilis</i> , <i>P. chrysocoma</i> .
Group 2-3	0.667	10	73.74	Paraonidae, Capitellidae, <i>N. agulhana</i> , <i>N. unicornis</i> , <i>L. ninetta</i> , Maldanidae, <i>E. vittata</i> , Terebellidae, <i>H. bilineata</i> , Sabellidae, <i>P. pictus</i> .
Group 2-4	0.917	10	75.54	Maldanidae, <i>P. arenosa</i> , Capitellidae, <i>N. unicornis</i> , <i>E. vittata</i> , <i>L. ninetta</i> , <i>N. agulhana</i> , <i>H. bilineata</i> , Terebellidae, <i>L. latreilli</i> , <i>P. pictus</i> .
Group 2-5	1	25	88.23	Capitellidae, <i>P. macroceros</i> , Maldanidae, <i>N. unicornis</i> , <i>E. vittata</i> , <i>N. agulhana</i> , <i>L. ninetta</i> , Terebellidae, <i>P. pictus</i>
Group 3-4	1	33.3	77.56	Paraonidae, <i>N. unicornis</i> , <i>P. arenosa</i> , Maldanidae, <i>H. bilineata</i> , <i>P. pictus</i> , Sabellidae, Capitellidae.
Group 3-5	1	33.3	89.63	Paraonidae, <i>P. macroceros</i> , <i>N. unicornis</i> , <i>H. bilineata</i> , Maldanidae, <i>P. pictus</i> .
Group 4-5	1	33.3	85.24	<i>P. macroceros</i> , <i>P. arenosa</i> , Capitellidae, <i>H. bilineata</i> , <i>L. latreilli</i>

Capítulo 4

Cambios en las comunidades de poliquetos

Table 4: Two-way ANOVA to test difference in abundances among meadows (*C. racemosa* and *P. oceanica*) and sampling dates. Species selected after the SIMPER percentages of similarity. *** very high significant differences (ANOVA, $p < 0.001$), ** high significant differences (ANOVA, $p < 0.01$), * significant differences (ANOVA, $p < 0.05$).

		<i>Arabella iricolor</i>	Paraonidae	Capitellidae	Cirratulidae	<i>Chrysopetalum debile</i>	<i>Eunice vittata</i>
Source of variation	Df	MS	MS	MS	MS	MS	MS
Meadow	1	2,526	0.256	0.436	2.411*	0.023	0.471
Date	9	0.895	0.774	0.995	0.441	0.222	1.208
Meadow*Date	9	0.589	0.723	4.776***	0.677	0.556	1.838
Residual	40	0.846	0.640	1.081	0.553	0.500	0.806
		<i>Harmothoe spinifera</i>	<i>Hyalinoecia bilineata</i>	<i>Lumbrineris gracilis</i>	<i>Lumbrineris latreilli</i>	<i>Lysidice ninetta</i>	Maldanidae
Meadow	1	2.824*	0.688	0.433	7.428**	3.775*	2.113
Date	9	0.566	1.507	0.792	2.653**	0.725	1.068
Meadow*Date	9	0.875	2.036	2.772**	1.231	1.012	1.882*
Residual	40	0.678	1.128	0.854	1.547	0.573	0.822
		<i>Neanthes agulhana</i>	<i>Nematoneis unicornis</i>	<i>Pectinaria (Lagis) koremi</i>	<i>Pelogenia arenosa</i>	<i>Pholoe inornata</i>	<i>Platynereis dumerilii</i>
Meadow	1	7.546*	5.179**	2.083*	12.198**	6.117**	0.055
Date	9	1.973	1.729**	0.380	0.767	0.361	0.926
Meadow*Date	9	1.566	2.198***	0.601	0.694	0.361	1.348
Residual	40	1.232	0.457	0.500	0.990	0.687	0.739
		<i>Polyophthalmus pictus</i>	<i>Pontogenia chrysocoma</i>	<i>Sthenelais boa</i>	<i>Syllis garciai</i>	Terebellidae	
Meadow	1	6.300*	0.333	3.390	5.851***	4.169*	
Date	9	1.738	1.496*	0.816*	2.375**	1.394	
Meadow*Date	9	1.419	1.892*	0.626	1.183**	0.742	
Residual	40	1.006	0.652	0.720	0.649	0.990	

Trophic guilds

No seasonal significant differences for the different trophic guilds were found in both *Caulerpa* mats and *Posidonia* meadow. The main polychaete trophic guilds did not change significantly between *Caulerpa* mats and *Posidonia* meadows, being (in order of importance according to its abundance) deposit feeders, carnivores and omnivores. In both types of samples, herbivores and filter feeders were less abundant (Fig. 5).

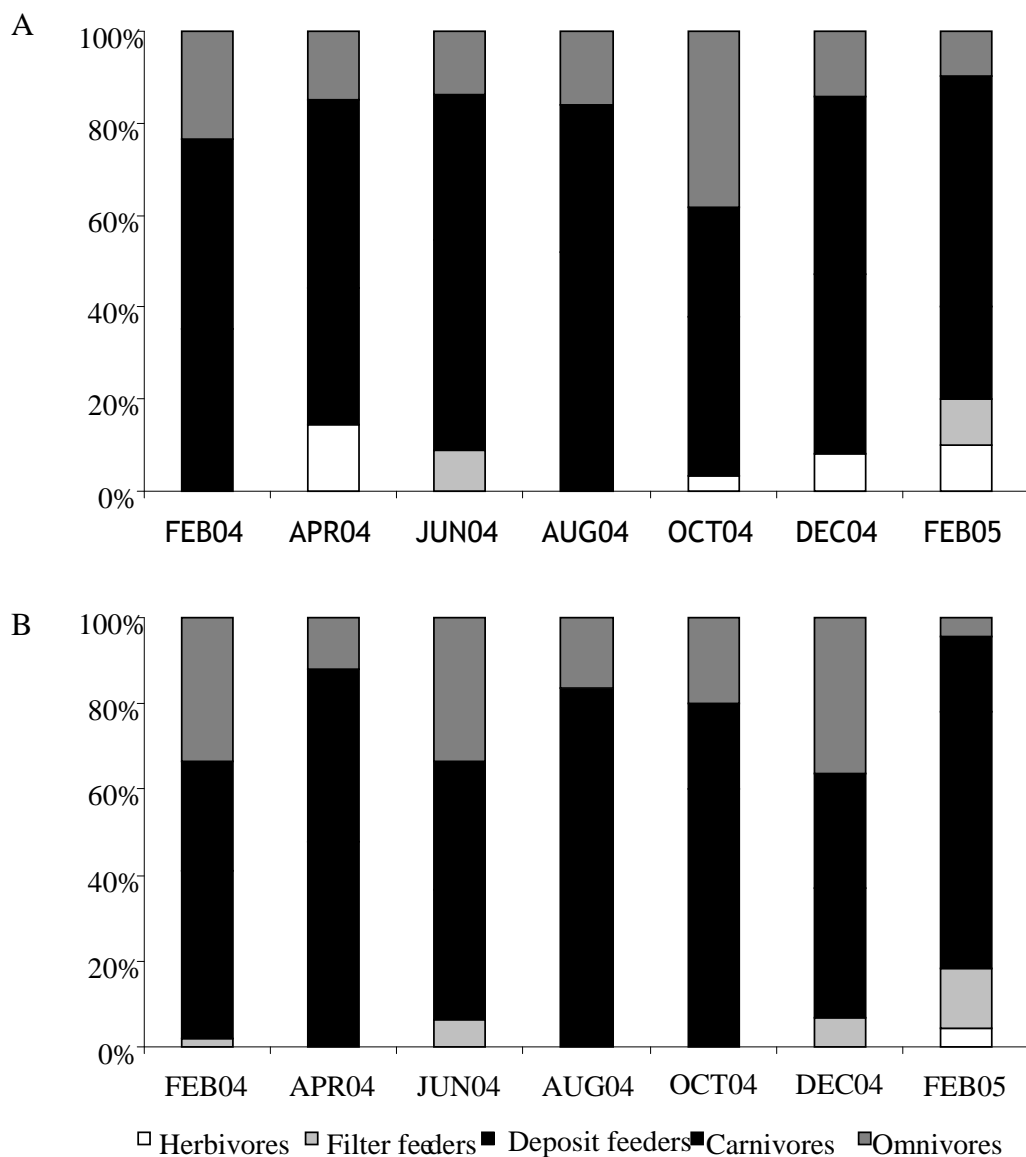

Figure 5: Seasonal contributions of the trophic guilds found in *Caulerpa* mats (A) and *Posidonia* meadows (B).

Discussion

The presence of the invasive *Caulerpa racemosa* spreading along the western Mediterranean appears to be associated to characteristic patterns of abundance and diversity of the polychaete assemblages, as well as to a specific seasonality. The loose of *Posidonia oceanica* aboveground structures (leaves and vertical sheaths) in mats invaded by *C. racemosa* changed the habitat structure (with the short fronds and complex stolon network of the algae) as well as the dynamics of the associated polychaete assemblage (particularly due to the marked seasonality of the algal biomass). When compared to living *P. oceanica* meadows, the effects of the invasion revealed to be non-negative. In fact, the abundance and number of species of the polychaete assemblages tended to increase, as previously reported for soft-bottoms colonised by *C. racemosa* (Argyrou, 1999).

The composition of the polychaete assemblages associated to *Caulerpa* mats did not show a clear between-sample differentiation in species composition. In other words, the assemblages were very uniform, most of them including also common soft bottom species, as reported for living *Posidonia* meadows (Gambi et al. 1995, Gambi et al. 1998, Brito et al. 2005). In the study area, several of the most abundant species in *Caulerpa* mats also occurred in *Posidonia* meadows and *viceversa* (i.e. *Pelogenia arenosa*, *Polyaphtalmus pictus*, *Lumbrineris latreilli* and *Arabella iricolor*, on one side, and *Nematonereis unicornis*, *Aponuphis bilineata*, *Lysidice ninetta* and *Eunice vittata* on the other). In fact, the increase or decrease in abundances of coincident polychaete species seems to be a characteristic trend when comparing living *P. oceanica* and dead mats invaded by *C. racemosa*. However, only *Neanthes agulhana* was dominant in both habitats, but it was significantly more abundant in *Caulerpa* mats.

Accordingly, the most abundant polychaete family in *Caulerpa* mats (and the second most one in *Posidonia* meadows) was the Nereididae, as previously reported for seagrass systems (Gambi et al. 1998). In addition to *Neanthes agulhana*, nereidids were represented by the omnivorous species, *Neanthes caudata* and *Platynereis dumerilii*. The second most abundant family in *Caulerpa* mats was the carnivorous Sigalionidae (also relatively less abundant in *Posidonia* mats). As a general trend, carnivorous species tended to increase their abundance in *Caulerpa* mats. We

postulated that a major availability of preys in *Caulerpa* mats, i.e. other polychaetes (this paper) and molluscs (Box, 2007), could be the responsible of this increasing presence of carnivores, both polychaetes (this paper) and crustaceans (A. Box, personal observations). Nevertheless, this tendency towards a relative increase of carnivores and an associated reduction of deposit feeders was non-significant, likely due to the actual stage of the invasion and deposit feeders were dominant both in *Caulerpa* mats and in *Posidonia* meadows too. Therefore, we may conclude that the invasion by *Caulerpa racemosa* did not affect the trophic composition of the associated polychaete assemblages.

In turn, a characteristic trend of the polychaete assemblages harboured by the *Caulerpa* mats was the particular seasonal dynamics, which showed the highest density, species richness and diversity during summer and autumn. This clearly differs from those associated to *Posidonia* meadows, which raised up during winter, as previously reported (Gambi et al. 1995). Our results demonstrate that these seasonal peaks were linked to maximums of *Caulerpa* biomass. Thus, we postulated that the increasing spatial complexity provided by a high biomass their stolons and fronds, growing over the dead seagrass mat layer, increased the complexity of the habitat and enhanced the structuring of the polychaete assemblage. During summer and autumn, the invasive algae grew quickly and formed extensive mats of stolons, which trapped sediments to the extreme that the lower vegetation layers may be affected (Balata et al. 2004). The stolon/frond network was less complex in winter and spring and, correspondingly, low polychaete densities and diversities were found. The co-generic invasive *Caulerpa taxifolia* also develops a network of stolons on the substratum surface and possesses a rhizoid system allowing this alga to colonize virtually all substrates (Levi & Francour 2004). As a result, specialized species such as the fish *Mullus surmuletus* suffered strong decreases in densities in the presence of *C. taxifolia* (Longepierre et al. 2005). *Caulerpa racemosa* also developed a similar network complex, thus having similar effects on *M. surmuletus* and other benthic-feeders fishes (A. Box, personal observations). However, the sharp decrease of its biomass species during winter may reduce the overall impact over the invaded communities.

The presence of *Caulerpa racemosa* seemed to cause a significant reduction in the density of several polychaetes that are characteristic of *Posidonia* meadows, such as some species of Eunicidae (e.g. *Nematonereis unicornis* and *Lysidice ninetta*), which were also among the major contributors to the dissimilarity among *Caulerpa*

mats and *Posidonia* meadows in the SIMPER analysis. However, the reasons of this negative effect are not clear, as it is not possible to assess whether it has a trophic basis – these species feed over *P. oceanica* scales according to Gambi et al. (2003, 2005) – or a chemical basis - linked to the secondary metabolites produced by the algae that may either affect grazing directly or indirectly through the inhibition of the growth or death of *P. oceanica* (Raniello et al. 2007).

Besides, the marked changes in the associated polychaete assemblages induced by the increasing *Caulerpa racemosa* biomass tended to be stable through time, as revealed by the high similarity of the samples collected in August, October and December (which strongly influence the observed seasonal patterns). In addition, minimum *C. racemosa* biomasses were observed during the coldest months (i.e. February 2004 and April 2005), in parallel with a reduction in the polychaete abundance and diversity at the *Caulerpa* mats. *Posidonia* meadows did not show such a seasonal pattern, and the values were more homogeneous and stable through the year and relatively higher in winter. Compared with a bare sandy bottom, its presence increases the amount of fine particles and organic matter (Brito et al. 2005), but this is also true when compared to the winter, less dense *Caulerpa* mats from the study area. Living *Posidonia* meadows also harbour less abundant and rich polychaete assemblages than dead mats in summer (Borg et al., 2006). This difference, however, seems more likely to be related to changes in the dynamics of the assemblages associated to the former, when they present the lowest annual polychaete diversity (Gambi et al. 1995). As non-invaded dead mats do not occur in the studied area, however, it has not been possible to isolate this particular effect in our analyses.

It seems evident that exotic species introduction, together with habitat degradation, fragmentation and overexploitation (among other processes), may cause a reduction of species richness at large spatial scales (Rosenzweig, 2001). The overall biodiversity of the recipient benthic communities can be modified by introducing species, but the effects can either be negative (Galil & Zenetos 2002; Zenetos et al 2003; Streftaris & Zenetos 2006) or positive (Viejo 1999; Crooks 2002; Buschbaum et al. 2006), with the enhanced diversity of the invaded communities being mainly due to the increased habitat complexity. Moreover, recent colonisations by exotic plants, animals and microbes have been reported to locally increase species richness (Rosenzweig 2001; Sax & Gaines 2003). Therefore, the introduction of exotic species may have diverse impacts at local and temporal scales. The effects cannot be

generalised and each invasions event must be studied independently (Buschbaum et al. 2006).

In summary, the invasive colonization of the *Posidonia oceanica* meadows by *Caulerpa racemosa* induces changes in the structure and functioning of the polychaete assemblages both at the spatial and temporal levels. Our results demonstrate that the species composition of the polychaete assemblages was similar in living and invaded *Posidonia* meadows, with only a few characteristic species being respectively replaced. In turn, they showed clear differences in abundance, mainly because the invasive *C. racemosa* generated a new habitat suitable for polychaetes. The increased complexity of the stolon and frond network built by the *Caulerpa* species not only enhanced the microhabitat availability, but constitutes an effective barrier against fish predators (Longepierre et al. 2005), favouring the presence of polychaetes. However, in the Balearic Islands, this is only valid for the warm period, as *C. racemosa* showed a nearly null biomass during cold periods that affected negatively the polychaete assemblages. In spite of the structural and seasonal changes, our results also points out that further interesting studies would address the functional aspects (e.g., bottom up and cascade effects, trophic web shifts) of the assemblages affected by an invasion by *C. racemosa*, as well as the relationships of the polychaetes with the whole benthic community.

Acknowledgements

This research was funded by the Science and Technology Ministry (Plan Nacional I+D (REN2002-00701/MAR)). The first author was funded by a postgraduate research grant I3P FSE. We are most grateful to J. Terrados and N. Marbà for their help during sample collection and *Caulerpa* mats characterization. We also thank A. Sureda and I. Moreno for their insightful comments on the manuscript.

References

- Amade P, Lemee R (1998) Chemical defence of the Mediterranean alga *Caulerpa taxifolia*: variations in caulerpenyne production. *Aquat Toxicol* 43:287-300.
- Antoniadou C, Chintiroglou C (2006) Trophic relationships of polychaetas associated with different algal growth forms. *Helgoland Mar Res* 60:39-49.
- Argyrou M, Demetropoulos A, Hadjichristophorou M (1999) Expansion of the macroalga *Caulerpa racemosa* and changes in softbottom macrofaunal assemblages in Moni Bay, Cyprus. *Oceanol Acta* 22:517-528.
- Balata D, Piazzzi L, Cinelli F (2004) A comparison among assemblages in areas invaded by *Caulerpa taxifolia* and *C. racemosa* on a subtidal Mediterranean rocky bottom. *PSZNI Mar Ecol* 25:1-13.
- Ballesteros M, Castelló J, Gallés M, Sarda R (1987) Invertebrados algúícolas marinos de las islas pitiusas. *Consell Insular d'Eivissa i Formentera*. Ibiza.
- Bax N, Williamson A, Agüero M, Gonzalez E, Geeves W (2003) Marine invasive alien species: a threat to global biodiversity. *Mar Policy* 27: 313-323.
- BellanSantini D, Arnaud PM, Bellan G, Verlaque M (1996) The influence of the introduced tropical alga *Caulerpa taxifolia*, on the biodiversity of the Mediterranean marine biota. *J Mar Biol Assoc UK* 76:235-237.
- Borg JA, Rowden AA, Attrill MJ, Schembri PJ, Jones MB (2006) Wanted dead or alive: high diversity of macroinvertebrates associated with living and 'dead' *Posidonia oceanica* matte. *Mar Biol* 149:667-677.
- Boudouresque CF, Lemee R, Mari X, Meinesz A (1996) The invasive alga *Caulerpa taxifolia* is not a suitable diet for the sea urchin *Paracentrotus lividus*. *Aquat Bot* 53:245-250.
- Boudouresque CF, Verlaque M (2002) Biological pollution in the Mediterranean Sea: invasive versus introduced macrophytes. *Mar Pollut Bull* 44:32-38.
- Box A, Deudero S, Pons G (2007) *Caulerpa racemosa* (Forsskal) induces shifts in the molluscan species composition at *Posidonia oceanica* (L.) Delile seagrass meadows. *Rapp Comm Mer Medit* 38:440.
- Brito MC, Martin D, Nunez J (2005) Polychaetas associated to a *Cymodocea nodosa* meadow in the Canary Islands: assemblage structure, temporal variability and

- vertical distribution compared to other Mediterranean seagrass meadows. *Mar Biol* 146:467-481.
- Buia MC, Gambi MC, Zupo V (2000) Structure and functioning of mediterranean seagrass ecosystems: an overview. *Biol Mar Medit* 7:167-190.
- Buia MC, Gambi MC, Terlizzi A, Mazzella L (2001) Colonization of *Caulerpa racemosa* along the southern italian coast: I. Distribution, phenological variability and ecological role. In: Gravez V, Ruitton S, Boudouresque CF, Le Direac'h L, Meinesz A, G. S (eds) Fourth International Workshop on *Caulerpa taxifolia*. GIS Posidonie, France, p 352-360.
- Buschbaum C, Chapman AS, Saier B (2006) How an introduced seaweed can affect epibiota diversity in different coastal systems. *Mar Biol* 148: 743-754.
- Ceccherelli G, Piazzzi L, Cinelli F (2000) Response of the non-indigenous *Caulerpa racemosa* (Forsskal) J-Agarth to the native seagrass *Posidonia oceanica* (L.) Delile: effect of density of shoots and orientation of edges of meadows. *J Exp Mar Biol Ecol* 243: 227-240.
- Ceccherelli G, Piazzzi L, Balata D (2002) Spread of introduced *Caulerpa* species in macroalgal habitats. *J Exp Mar Biol Ecol* 280: 1-11.
- Crooks JA (2002) Characterizing ecosystem-level consequences of biological invasions: the role of ecosystem engineers. *Oikos* 97: 153-166.
- Der Hartog C (1994) Suddocation of a littoral *Zoostera* bed by *Enteromorpha radiata*. *Aquat Bot* 47: 21-28.
- Fauchald K, Jumars P (1979) The diet of worms: a study of Polychaeta feeding guilds. *Oceanog Mar Biol Ann Rev* 17:193-284.
- Galil B S, Zenetos A (2002). A sea change -exotics in the Eastern Mediterranean Sea. In: Leppäkoski E, Gollasch S, Olenin S (eds) *Invasive Aquatic Species in Europe, Distribution, Impacts and Management*. Kluwer Academic Publishers, Dordrecht, Boston, London
- Gambi MC, Lorenti M, Russo GF, Scipione MB, Zupo V (1992) Depth and Seasonal Distribution of Some Groups of the Vagile Fauna of the *Posidonia oceanica* Leaf Stratum - Structural and Trophic Analyses. *Mar Ecol* 13:17-39.
- Gambi MC, Giangrande A, Martinelli M, Chessa LA (1995) Polychaetas of a *Posidonia oceanica* Bed Off Sardinia (Italy) - Spatiotemporal Distribution and Feeding Guild Analysis. *Sci Mar* 59:129-141.

- Gambi MC, Conti G, Bremec CS (1998) Polychaeta distribution, diversity and seasonality related to seagrass cover in shallow soft bottoms of the Tyrrhenian Sea (Italy). *Sci Mar* 62:1-17.
- Gambi MC, van Tussenbroek BI, Brearley A (2003) Mesofaunal borers in seagrasses: world-wide occurrence and a new record of boring polychaetas in the Mexican Caribbean. *Aquat Bot* 76:65-77.
- Gambi MC, Trani B, Buia MC (2005) Taxonomic diversity and distribution of polychaeta and isopod borers on the sheaths of the seagrass *Posidonia oceanica*: analysis at regional scale along the coast off Sardinia (Italy). *Ital J Zool* 72:141-151.
- Givernaud TJ, Cosson J, Givernaud-Mouradi A (1991) Etudes des populations de *Sargassum muticum* sur les cores de Basse, Normandies (France). In: Elliott M, Ducrotoy JP (eds) 19th Symposium Estuarines and Coasts: Spatial and Temporal Intercomparison. International Symposium Series, pp 129-132
- Gollasch S (2006) Overview on introduced aquatic species in European navigational and adjacent waters. *Helgoland Mar Res* 60:84-89.
- Jung V, Thibaut T, Meinesz A, Pohnert G (2002) Comparison of the wound-activated transformation of caulerpenyne by invasive and noninvasive *Caulerpa* species of the Mediterranean. *J Chem Ecol* 28:2091-2105.
- Levi F, Francour P (2004) Behavioural response of *Mullus surmuletus* to habitat modification by the invasive macroalga *Caulerpa taxifolia*. *J Fish Biol* 64:55-64.
- Longepierre S, Robert A, Levi F, Francour P (2005) How an invasive alga species (*Caulerpa taxifolia*) induces changes in foraging strategies of the benthivorous fish *Mullus surmuletus* in coastal Mediterranean ecosystems. *Biodivers Conserv* 14:365-376.
- Mack RN, Simberloff D, Lonsdale WM, Evans H, Clout M, Bazzaz FA (2000) Biotic invasions: Causes, epidemiology, global consequences, and control. *Ecol Appl* 10:689-710.
- Martin D, Pinedo S, Sarda R (2000) Distribution patterns and trophic structure of soft-bottom polychaeta assemblages in north-western Mediterranean shallow-water bay. *Ophelia* 53:1-17.
- Meinesz A (2004) *Caulerpa taxifolia* continues its invasion. *Biofutur* 244: 41-46.

- Meinesz A, Belsher T, Thibaut T, Antolic B, Mustapha K B, Boudouresque C F, Chiaverini D, Cinelli F, Cottalorda J M, Djellouli A S, El Abed A, Orestano C, Grau A M, Ivesa L, Vaugelas I, Zavodnik N., Zuljevic A (2001) The introduced green alga *Caulerpa taxifolia* continues to spread in Mediterranean. Biol Inv 3: 201-210.
- Montefalcone M, Morri C, Peirano A, Albertelli G, Bianchi C N (2007) Substitution and phase shift within the *Posidonia oceanica* seagrass meadows of NW Mediterranean Sea. Est Coast Shelf Sci 75: 63-71.
- Pandolfo A, Chemello R (1995) Prime nota sulla malacofauna associata a *Caulerpa racemosa* nella Baia di Santa Panagia (Sicilia orientale). Biol Mar Med 2:649-651.
- ParentMassin D, Fournier V, Amade P, Lemee R, DurandClement M, Delescluse C, Pesando D (1996) Evaluation of the toxicological risk to humans of caulerpenyne using human hematopoietic progenitors, melanocytes, and keratinocytes in culture. J Toxicol Env Health 47:47-59.
- Pesando D, Lemee R, Ferrua C, Amade P, Girard JP (1996) Effects of caulerpenyne, the major toxin from *Caulerpa taxifolia* on mechanisms related to sea urchin egg cleavage. Aquat Toxicol 35:139-155.
- Pesando D, Huitorel P, Dolcini V, Amade P, Girard JP (1998) Caulerpenyne interferes with microtubule-dependent events during the first mitotic cycle of sea urchin eggs. Eur J Cell Biol 77:19-26.
- Piazzzi L, Cinelli F (1999) Development and seasonal dynamics of a population of the tropical alga *Caulerpa racemosa* (Forsskal) J. Agardh in the Mediterranean. Cryptogamie Algol 20:295-300.
- Piazzzi L, Cinelli F (2000) Effects of the spread of the introduced Rhodophyceae *Acrothamnion preissii* and *Womersleyella setacea* on the macroalgal community of *Posidonia oceanica* rhizomes in the western Mediterranean sea. Cryptogam Algol 21: 291-300.
- Raniello R, Mollo E, Lorenti M, Gavagnin M, Buia MC (2007) Phytotoxic activity of caulerpenyne from the Mediterranean invasive variety of *Caulerpa racemosa*: a potential allelochemical. Biological Invasions 9: 361-368
- Rosenzweig ML (2001) The four questions: What does the introduction of exotic species do to diversity? Evol Ecol Res 3: 361-367.

- Sakai AK, Allendorf FW, Holt JS, Lodge DM, Molofsky J, With KA, Baughman S, Cabin RJ, Cohen JE, Ellstrand NC, McCauley DE, O'Neil P, Parker IM, Thompson JN, Weller SG (2001) The population biology of invasive species. *Annu Rev Ecol Syst* 32:305-332.
- Sax DF, Gaines SD (2003) Species diversity: from global decreases to local increases. *Trends Ecol Evol* 18: 561-566.
- Streftaris N, Zenetos A (2006) Alien Marine Species in the Mediterranean - th 100 'Worst Invasives' and their impact. *Mediterranean Mar Sci* 7/1: 87-118.
- Sureda A, Box A, Ensenat M, Alou E, Tauler P, Deudero S, Pons A (2006) Enzymatic antioxidant response of a labrid fish (*Coris julis*) liver to environmental caulerpenyne. *Comp Biochem Physiol C* 144:191-196.
- Verlaque M, Durand C, Huisman JM, Boudouresque CF, Le Parco Y (2003) On the identity and origin of the Mediterranean invasive *Caulerpa racemosa* (Caulerpales, Chlorophyta). *Eur J Phycol* 38:325-339.
- Viejo R M (1999). Mobile epifauna inhabiting the invasive *Sargassum muticum* and two local seaweeds in northern Spain. *Aquat Bot* 64: 131-149.
- Zenetos A, Gofas S, Russo GF, Templado J (2003) CIESM Atlas of Exotic Species in the Mediterranean, Volume 3: Mollusc. CIESM Publishers, Monaco.
- Zuljevic A, Antolic B, Onofri V (2003) First record of *Caulerpa racemosa* (Caulerpales : Chlorophyta) in the Adriatic Sea. *J Mar Biol Assoc UK* 83:711-712.

4.3 Community structure and trophic guilds: Differences in seagrass polychaete assemblage between invasive *Caulerpa taxifolia* and established *C. prolifera*

Abstract

We found notable similarities in polychaete assemblages of established *Caulerpa prolifera* and invasive *C. taxifolia*. Most of the identified species of *C. prolifera* and *C. taxifolia* were typical of soft bottom substrates. *Neanthes agulhana*, *Pista cretacea* and *Sphaerosyllis pirifera* were the dominant species of *C. prolifera*, while *Hyalionecia bilineata*, *N. agulhana* and *Lumbrineris latreilli* were dominant in *C. taxifolia*. There were significant differences in polychaete assemblages during the first sampling year, but these differences disappeared during the second sampling year. The higher abundance of *N. agulhana* in *C. prolifera* and of *Hyalionecia bilineata* in *C. taxifolia* (during the first sampling year) was the primary driver of differences in polychaete assemblage between *Caulerpa* species. The number and diversity of species present fluctuated from the first year to the second. *C. prolifera* exhibited a maximum abundance during October 2004, with 1141 ± 27 individual m^{-2} , while *C. taxifolia* experienced maximum abundance during March 2003, with 458.33 ± 148.72 ind. m^{-2} . The maximum number of polychaete species of *Caulerpa prolifera* was found during October 2004, with 16.00 ± 3.81 species, and *C. taxifolia* contained a maximum number of species during February 2005 14.5 ± 3.47 . Analysis of the trophic guild exposed differences between both *Caulerpa*. Significantly more carnivores, filter feeders, herbivores, and omnivores were found in *C. prolifera*, although there were no significant differences in deposit feeders. Most notably we found a high level of similarity between polychaete assemblages for both *Caulerpa* species. Changes between meadows were to differences in the abundances of coincident species. The polychaete community found in *C. taxifolia* was highly similar to and influenced by the nearby *P. oceanica* seagrass meadow.

Keywords: *Caulerpa*, polychaete, Western Mediterranean, invasive species, benthos, trophic guilds.

Introduction

Biological invasions are some of the most influential global anthropogenic impacts, with far-reaching influences in ecological, economic and social systems (Sakai et al. 2001; Occhipinti-Ambrogi and Savini 2003). International shipping, aquaculture, aquarium trade and artificial ingression between different marine regions all promote introduction of alien species into marine ecosystems (Occhipinti-Ambrogi and Savini 2003; Galil 2007). Invasive species alter biodiversity and change the structure of the native ecosystem (Mack et al. 2000; MacDougall and Turkington 2005). Replacement of native species by invading exotic species is becoming a common worldwide phenomenon (Montefalcone et al. 2007). The brown alga *Sargassum muticum*, for example, has replaced *Zostera marina* in damaged beds off the French Atlantic coast (Givernaud et al. 1991). Furthermore, the green algae *Enteromorpha radiata* has spread in deteriorated mixed beds of *Zostera noltii* and *Z. marina* in Great Britain coasts (Den Hartog 1994).

Currently, 662 alien species have been described in the Mediterranean Sea (Gollasch 2006), and 84 of these are introduced macrophytes (Boudouresque and Verlaque 2002). *Caulerpa taxifolia* and *C. racemosa* are two of the most invasive Mediterranean macrophytes (Ceccherelli et al. 2002). The presence of both of these invasive species has induced changes in composition and abundance of native fauna in local ecosystems (Pandolfo and Chemello 1995; BellanSantini et al. 1996; Argyrou et al. 1999; Buia et al. 2001). *Caulerpa* species produce anti-herbivorous secondary metabolites (Amade and Lemee 1998; Jung et al. 2002), including large amounts of caulerpenyne, which impacts negatively any grazing organisms (Boudouresque et al. 1996; Pedrotti et al. 1996; Pesando et al. 1996; Sureda et al. 2008) and induces chemical and environmental changes of the habitat (Amade and Lemee 1998; Sureda et al. 2006).

Caulerpa taxifolia (Vahl) C. Agardh was introduced to the Mediterranean in 1984 (Meinesz and Hesse 1991), and it rapidly spread across the western Mediterranean basin (Meinesz et al. 2001). In the Balearic Islands, *C. taxifolia* first appeared in 1992 at Cala d'Or Bay at a depth of six meters (Pou et al. 1993). Currently, this species is restricted to Cala d'Or Bay, and no expansion had been observed (personal observation). The primary effects of *C. taxifolia* in local ecosystems are the

disruption of vegetative development of *Posidonia oceanica* L. Delile (Devillele and Verlaque 1995; Dumay et al. 2002) and the reduction of the algal diversity in the invaded ecosystems (Balata et al. 2004; Verlaque et al. 2004). *C. taxifolia* is considered an invasive species, but, in the Mediterranean basin, another *Caulerpa* is considered the established native. This species, *Caulerpa prolifera*, is widespread throughout the Mediterranean basin, with the exceptions of Lion Gulf and the Adriatic Sea. Since it is an algae with subtropical affinity, *C. prolifera* growth and spatial distribution are highly influenced by water temperature (Sanchez-Moyano et al. 2004). *C. prolifera* can be found over soft bottoms from depths of 1 to 20 meters, mainly in regions of little water flow and low hydrodynamics (Sanchez-Moyano et al. 2001a; Sanchez-Moyano et al. 2004).

The presence of invasive species affects invertebrate assemblages, including those associated with seagrass beds. The effect of invasive species among invertebrate assemblages is not clear, and it may enhance (Argyrou 1999; Antoniadou and Chintiroglou 2007) or impair (Galil and Zenetos 2002; Zenetos et al 2003; Streftaris and Zenetos 2006) local diversity. Polychaetes are considered to be excellent indicators of faunal assemblages structure, including those associated with seagrasses (Gambi et al. 1998; Brito et al. 2005).

The aim of the current study was to compare polychaete assemblages between *Caulerpa taxifolia* and *C. prolifera* in terms of polychaete abundances, diversity and polychaete trophic guilds. This study represents the first description of the effects of *C. taxifolia* on polychaete community in the western Mediterranean, and it will contribute to a better understanding of the *C. prolifera* polychaete community.

Material and methods

Study area

The study was performed in Mallorca Island (Western Mediterranean). In Cala d'Or Bay, two sites with similar bathymetry (5-8 meters) and similar hydrodynamic processes were selected for study. Samples were collected at both sites from *Caulerpa* species growing over *Posidonia oceanica* rhizomes. Sampling site coordinates for *C. taxifolia* were N 39° 22.164' / E 3° 13.887' and were N 39° 22.028' / E 3° 13.739' for

C. prolifera. In both areas, *Caulerpa* mats do not form monoespecific mats but grow over *P. oceanica* rhizome patches rounded by sand bottoms and in *Posidonia oceanica* seagrass meadows.

Sampling methodology

For each meadow, four samples were collected twice per month during the period between March 2003 and February 2005. Each sample was collected using a 20 x 20 cm stainless steel frame inserted 5 cm into the sediment, collecting a total sample volume of 2000 cm³ with a surface area of 400 cm². The frames were sampled by SCUBA diving in the morning (11-12 GTM). Samples were placed in a 500 µm mesh plastic bag until laboratory sorting. These samples were used to describe polychaete faunal composition, to estimate *P. oceanica* biomass, and to calculate the biomass of *Caulerpa*.

Concurrently with faunal sample collection, three cores (diameter 3.5 cm) per meadow were collected. The coring device was inserted 5 cm into sediment, and analysis allowed characterization of grain size parameters of each substrate. Seawater temperature was recorded by StowAway[®] Tidbit[®] (Onset Computer Corporation, Pocasset, MA, USA) temperature loggers permanently installed at each bay.

Polychaete species were sorted under a stereomicroscope, identified at the lowest taxonomic level possible, and then grouped into one of the following trophic guilds: carnivores, herbivores, omnivores, deposit feeders or filter feeders (Fauchald and Jumars 1979; Gambi et al. 1995; Martin et al. 2000; Antoniadou and Chintiroglou 2006). For statistical analyses, the species of *Paraonidae*, *Capitellidae*, *Sabellidae* and *Maldanidae* were pooled at the level of family due the misidentification of several individuals.

Rhizomes, roots, sheaths and leaves of *Posidonia oceanica* were sorted and dried for 24 h at 60 °C, and biomass was quantified as dry weight (DW) and expressed as percentages. *Caulerpa* biomass was also sorted from the samples, and, after drying for 24 h at 60 °C, dry weight was quantified

Statistical analysis

In order to characterize the assemblages of polychaetes associated with *Posidonia* meadows and *Caulerpa* mats, the different *Posidonia oceanica* structures (rhizomes, sheaths, live leaves, dead leaves and roots) were separated and quantified. Differences between *Posidonia* meadows and *Caulerpa* mats were tested for each *Posidonia* structure by two-way analysis of variance (ANOVA) with meadow and date as factors.

Indexes of dominance and frequency of the polychaete assemblages were calculated, and species were classified either as dominant ($D \geq 1\%$) or not dominant ($D \leq 1\%$) and as constant (frequency $\geq 50\%$), accessory ($25\% \leq \text{frequency} \leq 50\%$) or accidental (frequency $\leq 25\%$).

The polychaete assemblages between March 2003 and February 2005 were analysed using PRIMER 5.0 software (Clarke and Warwick, 1994). CLUSTER analysis was performed with a similarity matrix (Bray-Curtis similarity) estimated using a fourth-root transformed abundance per sample matrix, with replicate samples pooled by meadow and sampling date. Occasional species (with dominance value below 1%) were not considered in the polychaete abundances analysis. Due to interannual variability in the samples, analyses were performed by grouping samples by *Caulerpa* species and sampling year (first sampling year, March 2003 to February 2004 and, second sampling years, April 2004 to February 05). The ANOSIM routine (Clarke and Warwick 1994) was applied to assess differences between the sampling groups. The polychaete species responsible for the observed differences were identified through the SIMPER routine.

The DIVERSE routine was used to obtain four descriptors of the polychaete assemblages: density, number of species per sample, diversity index and evenness (Clarke and Warwick 1994). Three-way nested analysis (with factors meadow, year and month nested within year and meadow) was performed to test changes in the community descriptors between *C. prolifera* and *C. taxifolia*. Pairwise correlations (Pearson test) were performed to assess relationships between the *Caulerpa* species in terms of both biomass and polychaete assemblages (grouped by meadow and sampling year). Three-way nested analysis (with factors meadow, year and month nested within year and meadow) was performed to test changes in the main trophic guilds between *C. prolifera* and *C. taxifolia*.

Results

Mats characterization

Statistical analyses did not reveal differences in the percentage contribution of *Posidonia oceanica* root-rhizomes and leaves between *Caulerpa prolifera* and *Caulerpa taxifolia* (Fig 1 a, b). We detected differences in grain size fractions between *Caulerpa* species (ANOVA $p < 0.05$). *C. prolifera* was primarily associated with very fine grain sizes, while *C. taxifolia* mats were characterised by a predominance of fine sand fractions (Fig 2 a, b).

Caulerpa biomass followed different seasonal trends for *C. prolifera* and for *C. taxifolia*. Higher biomass values in *C. prolifera* were recorded during February (2003) and March (2004), while, for *C. taxifolia*, higher biomass values were recorded in July (2003) and December (2004). There were significant differences in biomass between *C. prolifera* and *C. taxifolia*, (with greater biomass observed in *C. prolifera*), seasonality and the interaction of biomass and seasonality (ANOVA, $p < 0.05$) (Fig 3).

Faunistic composition

A total of 4575 polychaete specimens belonging to 40 taxa were counted in *Caulerpa prolifera* mats (Table 1). The assemblage showed a high diversity with 18 dominant species. Among these, the most abundant species were *Neanthes agulhana*, *Sphaerosyllis austriaca*, *Hyalinoecia bilineata*, *Lumbrineris latreilli* and *Lumbrineris gracilis*. The polychaete assemblage results indicated that 12 species were present in both *Caulerpa* species; these common species included *N. agulhana*, *Polyophtalmus pictus*, *Sphaerosyllis austriaca* and *Hyalinoecia bilineata*

In the invasive *Caulerpa taxifolia*, a total of 3033 polychaete specimens belonging to 36 taxa were identified over the two-year study period. Similar to *C. prolifera*, the *C. taxifolia* assemblage showed high diversity with 20 dominant species. The most abundant species were *Hyalinoecia bilineata*, *Neanthes agulhana*, *Lumbrineris latreilli*, *Nematonereis unicornis* and *Polyophtalmus pictus*. The *C. taxifolia* polychaete assemblage contained 11 constant species. The most common

species in this assemblage were *H. bilineata*, *N. agulhana*, *L. latreilli*, *N. unicornis* and *P. pictus*.

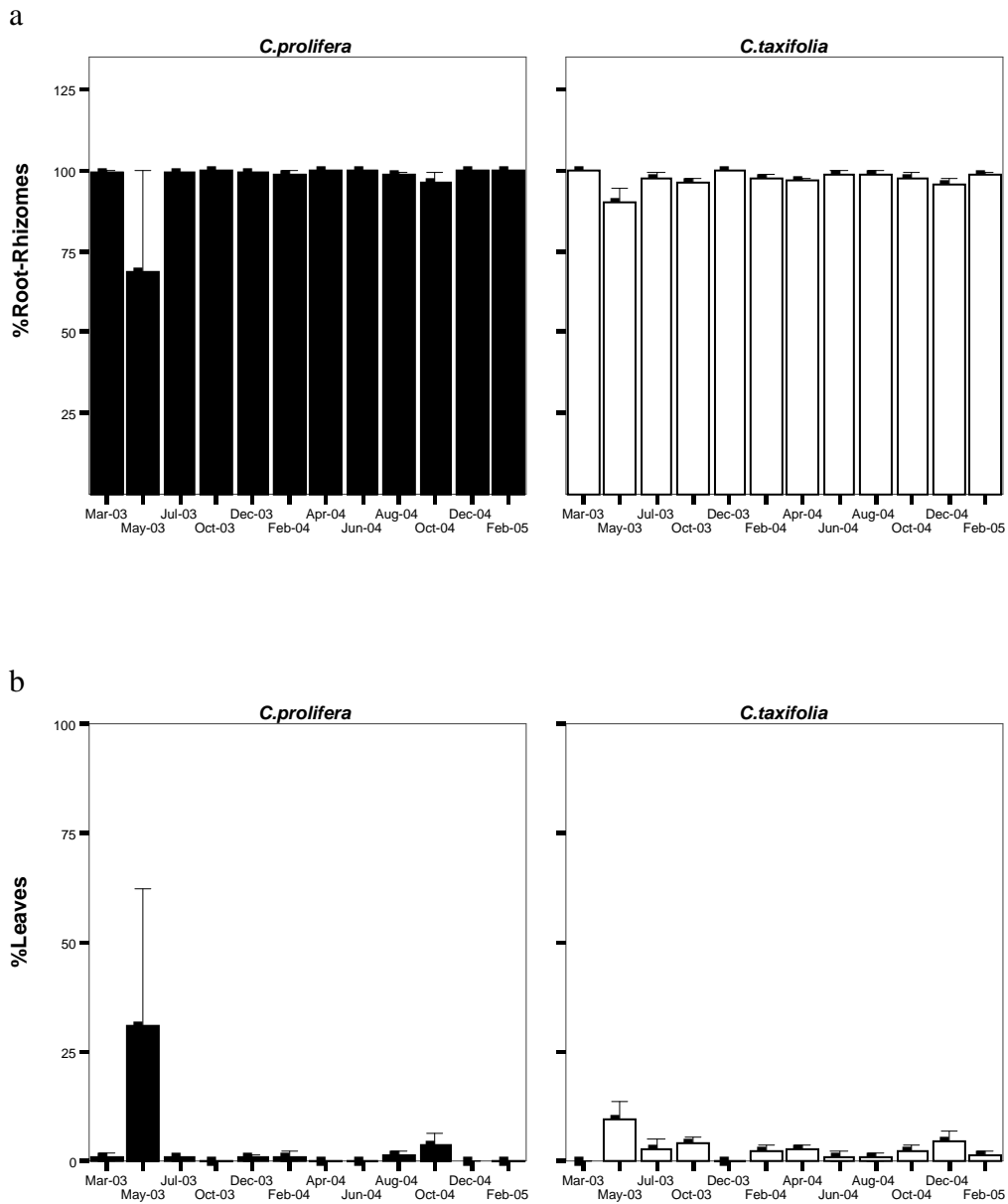

Figure 1: *Posidonia oceanica* fractions contribution percentage to samples in both *Caulerpa* mats along the study period. (a) Contribution percentage of roots and rhizomes (b) contribution of *Posidonia* leaves.

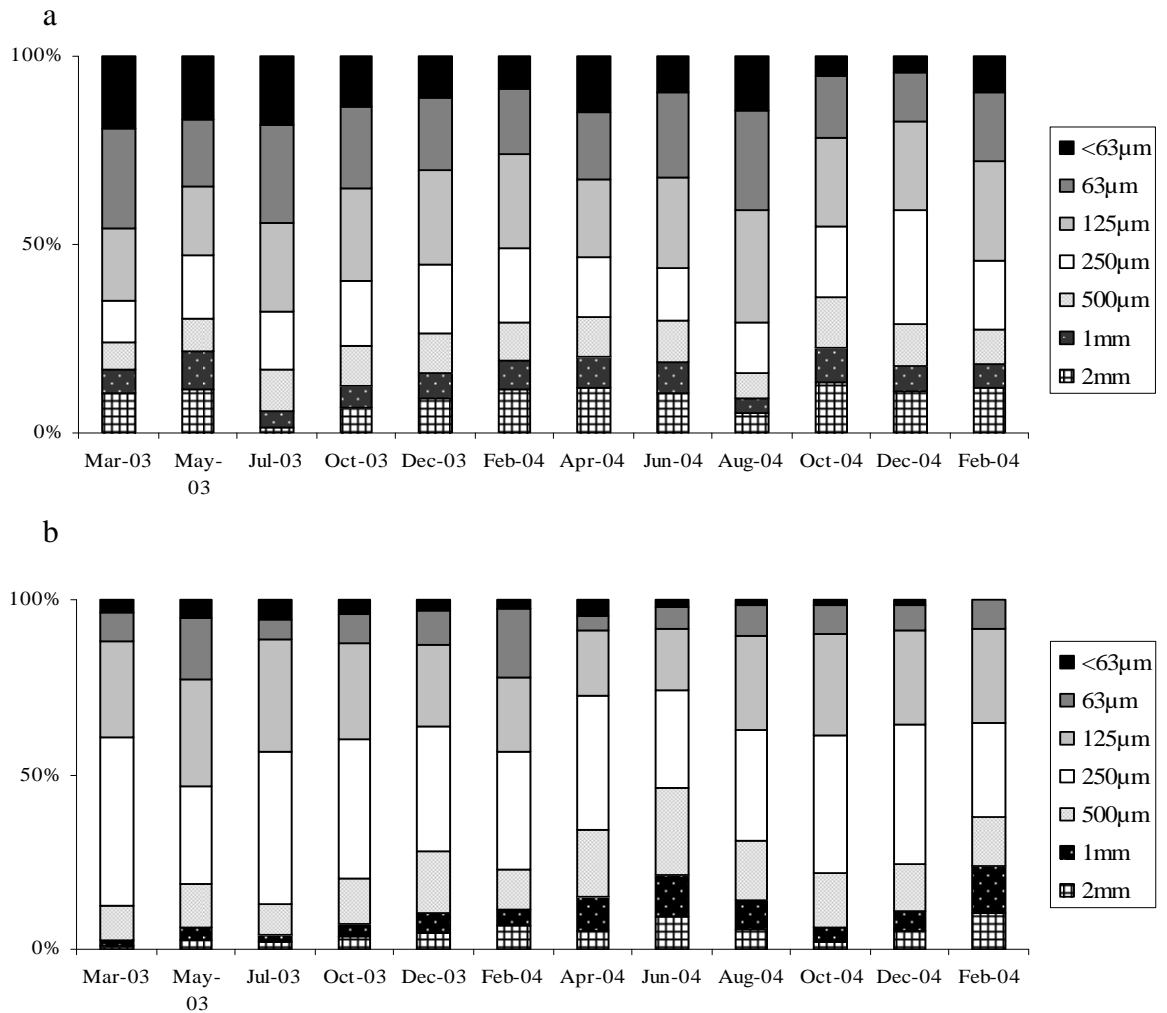

Figure 2: Seasonal variation in grain sizes distribution at sediments from (a) *Caulerpa prolifera* (b) *C. taxifolia*.

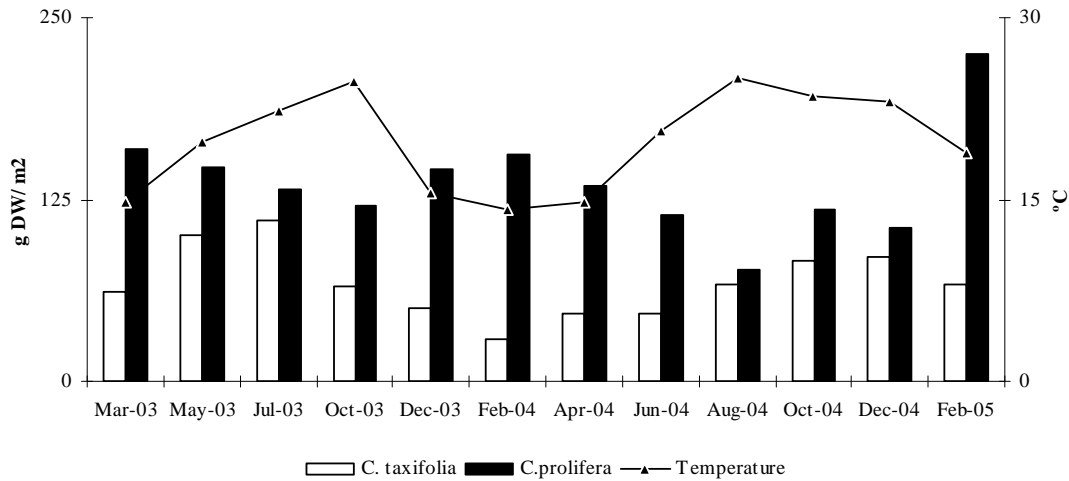

Figure 3: *Caulerpa proliferata* (black bar) and *C. taxifolia* (white bar) biomass seasonality and water temperature (continuous line) along the two-years sampling period.

Multivariate analysis

The multivariate analysis showed significant differences between years in *Caulerpa proliferata* polychaete assemblages (ANOSIM global R of 0.341, significance level 0.004). No differences were detected between the two years in the *C. taxifolia* polychaete assemblage (ANOSIM global R of -0.072, significance level 0.738). Our results indicate that the polychaete assemblages of each the *Caulerpa* mats were comparable on an annual basis (Table 3).

The most substantial differences between the *Caulerpa proliferata* polychaete assemblages during both sampling years were due to differences in relative abundances of the species *Neanthes agulhana*, *Hyalinoecia bilineata* and *Lumbrineris latreilli*. In *C. taxifolia*, differences in the polychaete assemblages were mainly due to the species *Hyalinoecia bilineata*, which experienced a notable reduction in abundance in 2004 (Table 3).

There were significant differences between *Caulerpa* mat assemblages during the first sampling year, but these differences were less prevalent during the second sampling year (Table 3). The species *Neanthes agulhana* contributed most significantly to the dissimilarity between polychaete assemblages in *Caulerpa* mats. This nereid worm was present in *C. proliferata* at a higher abundance during both years. *Hyalinoecia bilineata* also contributed to the dissimilarities, but it fluctuated in abundance between

years. During the first sampling year, the greatest abundance of polychaetes was found in *C. taxifolia*. However, during the second sampling year, the greatest polychaete abundance had shifted to *C. prolifera* mats (Table 3).

A cluster analysis of the average first sampling year (2003) polychaete abundance in *C. prolifera* and *C. taxifolia* produced a dendrogram with four main groups. Groups 1 and 3 contain *C. prolifera* polychaete assemblages, and Groups 2 and 4 contain *C. taxifolia* polychaete assemblages. Two sampling dates of *C. taxifolia* did not group with the others (Fig 4 A). Samples from 2004 were more similar between *Caulerpa* species, and only two main groups could be considered, as two samples did not group with the others. Group 1 contains samples from both mat types, supporting the SIMPER analysis that found few differences between polychaete assemblages from second sampling year (Fig 4 B).

Community descriptors

Polychaete communities in the two *Caulerpa* mat types differ in number of individuals. Except for the diversity index, all the main descriptors of polychaete communities showed differences between the two years. Differences between meadows, including number of individuals and evenness, were enhanced by interaction with the time of year (year by meadow). Seasonal changes in abundances did not follow a clear seasonal trend, which made it difficult to assess the biological cause of the observed trends (Table 4).

In *Caulerpa prolifera* mats, the maximum density of polychaetes was observed in October 2004, with 1141 ± 27 individuals per m^2 , due to a peak in *Neanthes agulhana* abundance. Elevated densities of polychaetes were also found during March and October 2003 (408 ± 32.80 and 400 ± 83.00 ind m^2 respectively; Fig 5A). Minimum abundances values occurred in August 2004, with 33.33 ± 5.89 individuals per m^2 . Polychaete abundances in *C. taxifolia* followed similar seasonal trends, with maximum densities in March 2003 and October 2004 (458.33 ± 148.72 and 450.00 ± 79.71 individuals per m^2 respectively). Polychaete abundances were minimum during May in 2003 and in August 2004 (91.67 ± 11.78 and 125.00 ± 27.00 individuals per m^2 respectively) (Fig 5B).

The number of species per sample revealed interannual variability in both meadows. The maximum number of polychaete species in *Caulerpa prolifera* was

observed during March and October 2003 and in October 2004 (10.00 ± 2.12 , 10.00 ± 2.51 and 16.00 ± 3.81 species respectively). The lowest abundance of polychaetes in *C. prolifera* (1.50 ± 0.50 species per sample) was observed in August 2004, when only *Arabella iricolor*, *Pelogenia arenosa* and *Nematonereis unicornis* were described (Fig 3 C). *C. taxifolia* and *C. prolifera* polychaete assemblages experienced similar seasonal fluctuations, with a maximum number of species during the first sampling year in December 2004 (9.00 ± 1.91), October 2004 (14.5 ± 3.30) and February 2005 (14.5 ± 3.47 ; Fig 3 D).

The Shannon-Weaver diversity index remained relatively constant throughout the year in *Caulerpa prolifera*, with maximum values observed in May 2003 and April 2004 (2.14 ± 0.19 and 2.22 ± 0.19 respectively). In August 2004, we observed a rapid reduction in diversity ($H' = 0.25 \pm 0.25$; Fig 3 E). Diversity values in *C. taxifolia* were higher at the end of both sampling years (February 2004 $H' = 2.05 \pm 0.14$ and October 2004 $H' = 2.45 \pm 0.22$). During the second sampling year, we observed an increase in diversity values in *C. taxifolia* mats (Fig 3 F).

Due to interannual variability in *Caulerpa* mat communities, we did not find any correlation between polychaete communities and temperature or *Caulerpa* biomass. However, when community descriptors were considered from each sampling year, significant correlations were found for both *Caulerpa* mats. In *C. prolifera*, the first sampling year yielded no significant Pearson correlations. During the second sampling year, the Shannon diversity was found to be positively correlated with *C. prolifera* biomass ($Rho = 0.464$ sig. level 0.05). During the first sampling year in the alien *C. taxifolia* mats, *Caulerpa* biomass was found to impact polychaete species number ($Rho = -0.406$ sig level 0.05) and Shannon-Wiener diversity ($Rho = -0.431$ sig level 0.05) negatively. This correlation was not observed during the second sampling year.

Table 1: Seasonal changes in the *Caulerpa prolifera* polychaeta expressed as individuals/m² sampled in Cala d'Or. Frequency = n° samples with presence/ total n° seasonal samples). Dominance = total number of specie individuals / total polychaeta number (expressed as percentage)

	Mar 03	May 03	Jul 03	Oct 03	Des 03	Feb04	Apr 04	Jun 04	Aug 04	Oct 04	Des 04	Feb 05	Total	Fequency	Dominance
<i>Neanthes agulhana</i>	191,7±15.6	25,0±0	25,0±10.2	41,7±11.8	8,3±5.9	75,0±36.8	66,7±25.7			366,7±124.7	25,0±10.2	83,3±35.8	908,3	83,3	19,9
Terebellidae	33,3±5.9	16,7±5.9	41,7±15.6	16,7±11.8	25,0±0	41,7±5.9	58,3±32.8	8,3±5.9		50,0±10.2	8,3±5.9	25,0±0	325,0	91,7	7,1
<i>Sphaerosyllis austriaca</i>	25,0±10.2			33,3±15.6	50,0±17.7	8,3±5.9				158,3±52.4	8,3±5.9	8,3±5.9	291,7	58,3	6,4
<i>Hyalinoecia bilineata</i>		25,0±17.7	8,3±5.9	16,7±11.8	16,7±11.8	41,7±29.4	16,7±11.7	158,3±21.2					283,3	58,3	6,2
<i>Lumbrineris latreilli</i>	8,3±5.9		8,3±5.9	158,3±79.3		16,7±11.8	8,3±5.9	16,7±5.9			41,7±21.2	8,3±5.9	266,7	66,7	5,8
Sabellidae						16,7±5.9				116,7±65.7	8,3±5.9	66,7±15.6	208,3	33,3	4,6
<i>Lumbrineris gracilis</i>		25,0±17.7	8,3±5.9	8,3±5.9	33,3±23.7		16,7±11.7	91,7±21.2			8,3±5.9		191,7	58,3	4,2
<i>Arabella bicolor</i>	16,7±11.8		16,7±11.8	16,7±5.9		16,7±11.8	16,7±5.9	8,3±5.9	16,7±11.8	41,7±15.6	8,3±5.9	8,3±5.9	166,7	83,3	3,6
<i>Polyopthalmus pictus</i>		16,7±5.9	8,3±5.9	8,3±5.9	8,3±5.9		16,7±11.7	8,3±5.9		33,3±23.57		66,7±21.25	166,7	66,7	3,6
Maldanidae		25,0±17.6	8,3±5.9		25,0±17.7		8,3±5.9	8,3±5.9		33,3±5.9	8,3±5.9	41,7±21.25	158,3	66,7	3,5
<i>Sphaerosyllis pirifera</i>				8,3±5.9						66,7±25.7	50,0±35.3	8,3±5.9	133,3	33,3	2,9
<i>Pelogenia arenosa</i>		25,0±10.2	8,3±5.9				8,3±5.9	8,3±5.9	8,3±5.9	33,3±23.6	25,0±17.7	8,3±5.9	125,0	66,7	2,7
<i>Pectinaria (Lagis) koremi</i>	33,3±15.6	16,7±5.9	25,0±10.2	16,7±5.7	8,3±5.9	8,3±5.9		8,3±5.9					116,7	58,3	2,6
<i>Eunice vittata</i>	16,7±5.9		8,3±5.9	8,3±5.9	16,7±11.8		25,0±0.0	8,3±5.9		16,7±11.8		8,3±5.9	108,3	66,7	2,4
Capitellidae		8,3±5.9		16,7±11.8	8,3±5.9	8,3±5.9	25,0±0.0	8,3±5.9		8,3±5.9	25,0±10.2		108,3	66,7	2,4
<i>Nematonereis unicornis</i>				16,7±11.8		8,3±5.9		8,3±5.9	8,3±5.9	25,0±0.0		16,7±5.9	83,3	50,0	1,8
<i>Pholoe inornata</i>	8,3±5.9	16,7±5.9	8,3±5.9			33,3±15.6				8,3±5.9			75,0	41,7	1,6
Syllis sp	8,3±5.9	16,7±5.9	25,0±10.2	8,3±5.9						8,3±5.9	8,3±5.9		75,0	50,0	1,6
Cirratulidae	8,3±5.9		8,3±5.9			8,3±5.9	16,7±5.9			25,0±10.2			66,7	41,7	1,5
Paraonidae								16,7±11.8		16,7±11.8	8,3±5.9	25,0±10.3	66,7	33,3	1,5
<i>Exogone (exogone) rostrata</i>								8,3±5.9		33,3±11.8		16,7±11.8	58,3	25,0	1,3
<i>Glycera</i> sp.							16,7±5.9			16,7±11.8	16,7±11.8	8,3±5.9	58,3	33,3	1,3
<i>Lysidice ninetta</i>	8,3±5.9		8,3±5.9	8,3±5.9	16,7±5.9		16,7±5.9						58,3	41,7	1,3
<i>Platynereis dumerilii</i>	16,7±5.9	8,3±5.9					16,7±11.8	8,3±5.9					50,0	33,3	1,1
<i>Pherusa eruca</i>	8,3±5.9				8,3±5.9		8,3±5.9					8,3±5.9	33,3	33,3	0,7
<i>Neanthes caudata</i>				8,3±5.9				16,7±5.9			8,3±5.9		33,3	25,0	0,7
<i>Harmothoe spinifera</i>	8,3±5.9						8,3±5.9	8,3±5.9				8,3±5.9	33,3	33,3	0,7
<i>Sthenelais boa</i>	8,3±5.9	8,3±5.9			8,3±5.9			8,3±5.9					33,3	33,3	0,7

<i>Syllis corallicola</i>				33,3±11.8		33,3	8,3	0,7
<i>Nereis falsa</i>					25,0±17.8	25,0	8,3	0,5
<i>Pontogenia chrysocoma</i>		8,3±5.9		8,3±5.9	8,3±5.9	25,0	25,0	0,5
<i>Armandia polyophthalma</i>				8,3±5.9	16,7±11.8	25,0	16,7	0,5
<i>Syllis garciai</i>	8,3±5.9		8,3±5.9		8,3±5.9	25,0	25,0	0,5
<i>Schistomeringos neglecta</i>		8,3±5.9		8,3±5.9		16,7	16,7	0,4
<i>Lumbrineris impatiens</i>	8,3±5.9				8,3±5.9	16,7	16,7	0,4
<i>Lumbrineropsis paradoxa</i>					8,3±5.9	8,3±5.9	16,7	16,7
<i>Malmgreniella lunulata</i>				16,7±11.8		16,7	8,3	0,4
<i>Syllis variegata</i>				8,3±5.9	8,3±5.9	16,7	16,7	0,4
<i>Syllis westheidei</i>			16,7±11.8			16,7	8,3	0,4
<i>Chrysopetalum debile</i>		8,3±5.9				8,3	8,3	0,2
<i>Schistomeringos rudolphi</i>					8,3±5.9	8,3	8,3	0,2
<i>Palolo siciliensis</i>			8,3±5.9			8,3	8,3	0,2
<i>Exogone (exogone) verugera</i>					8,3±5.9	8,3	8,3	0,2
<i>Acanthicolepis asperrima</i>		8,3±5.9				8,3	8,3	0,2
<i>Vermiliopsis striaticeps</i>						8,3±5.9	8,3	8,3
<i>Syllis gertlachi</i>						8,3±5.9	8,3	8,3

Table 2: Seasonal changes in the *Caulerpa taxifolia* polychaeta expressed as individuals/m² sampled in Cala d'Or. Frequency = n° samples with presence/ total n° seasonal samples). Dominance = total number of specie individuals / total polychaeta number (expressed as percentage)

	Mar 03	May 03	Jul 03	Oct 03	Des 03	Feb04	Apr 04	Jun 04	Aug 04	Oct 04	Des 04	Feb 05	Total	Frequency	Dominance
<i>Hyalinoecia bilineata</i>	291,7±129.2	16,7±11.8	50,0±20.4	66,7±15.9	41,7±11.8		66,7±38.6	16,7±5.9		33,3±15.9	8,3±5.9		591,7	75,0	19,5
Capitellidae	66,7±24.5	8,3±5.9		8,3±5.9	25,0±0.0	16,7±5.9	16,7±5.9	50,0±17.7	8,3±5.9	16,7±5.9	16,7±5.9	50,0±10.2	283,3	91,7	9,3
Terebellidae		8,3±5.9		8,3±5.9	8,3±5.9	16,7±11.8	33,3±23.6	25,0±10.2	8,3±5.9	33,3±5.9	16,7±5.9	25,0±10.2	183,3	83,3	6,0
<i>Neanthes agulhana</i>	8,3±5.9	8,3±5.9		8,3±5.9		16,7±5.9	16,7±5.9	16,7±5.9	8,3±5.9	41,7±29.5	8,3±5.9	50,0±10.2	183,3	83,3	6,0
<i>Lumbrineris latreilli</i>	16,7±5.9		8,3±5.9	8,3±5.9	8,3±5.9	41,7±15.9	8,3±5.9	25,0±17.7		33,3±15.6	8,3±5.9	8,3±5.9	166,7	83,3	5,5
<i>Nematonereis unicornis</i>		8,3±5.9		16,7±5.9	16,7±5.9	33,3±5.9		33,3±15.6	16,7±11.8	16,7±11.8	8,3±5.9	8,3±5.9	158,3	75,0	5,2
<i>Polyophthalmus pictus</i>	16,7±5.9	8,3±5.9		16,7±5.9	16,7±5.9	25,0±10.2		16,7±11.8		16,7±11.8	25,0±10.2	16,7±5.9	141,7	66,7	4,7
<i>Pelogenia arenosa</i>		8,3±5.9	8,3±5.9	8,3±5.9				8,3±5.9	8,3±5.9	25,0±17.8		41,7±21.2	108,3	58,3	3,6
<i>Harmothoe spinifera</i>			8,3±5.9				25,0±10.2		25,0±10.2	25,0±0.0	8,3±5.9	16,7±5.9	108,3	50,0	3,6
<i>Lysidice ninetta</i>			16,7±5.9		8,3±5.9	8,3±5.9		33,3±15.6		16,7±5.9	25,0±10.2		108,3	50,0	3,6
<i>Eunice vittata</i>		16,7±11.8		16,7±5.9	16,7±5.9			16,7±15.9		16,7±5.9			83,3	41,7	2,7
<i>Sphaerosyllis pirifera</i>			8,3±5.9	8,3±5.9	8,3±5.9	16,7±11.8					8,3±5.9	33,3±23.6	75,0	41,7	2,5
Paraonidae	8,3±5.9		8,3±5.9	8,3±5.9	8,3±5.9				8,3±5.9	33,3±15.6		8,3±5.9	75,0	50,0	2,5
Maldanidae		8,3±5.9	8,3±5.9			8,3±5.9				8,3±5.9	16,7±11.8	16,7±5.9	66,7	50,0	2,2
Sabellidae	8,3±5.9					16,7±11.8		8,3±5.9		8,3±5.9		16,7±5.9	58,3	41,7	1,9
<i>Sthenelais boa</i>				8,3±5.9	8,3±5.9		16,7±11.8			8,3±5.9	8,3±5.9	8,3±5.9	58,3	50,0	1,9
<i>Platynereis dumerilii</i>								8,3±5.9		25,0±17.7		16,7±11.9	50,0	25,0	1,6
<i>Pontogenia chrysocoma</i>						16,7±5.8		8,3±5.9	8,3±5.9		8,3±5.9	8,3±5.9	50,0	41,7	1,6
<i>Lumbrineris gracilis</i>			8,3±5.9	16,7±11.8			8,3±5.9					16,7±5.9	50,0	33,3	1,6
<i>Sphaerosyllis austriaca</i>	8,3±5.9		8,3±5.9							33,3±15.6			50,0	25,0	1,6
<i>Syllis garciai</i>					8,3±5.9	16,7±5.8			8,3±5.9			8,3±5.9	41,7	33,3	1,4
<i>Pholoe inornata</i>			8,3±5.9							16,7±5.9		16,7±5.9	41,7	25,0	1,4
<i>Lumbrineris impatiens</i>						8,3±5.9	8,3±5.9	8,3±5.9		8,3±5.9			33,3	33,3	1,1
<i>Lumbrineropsis paradoxa</i>	8,3±5.9							8,3±5.9		8,3±5.9		8,3±5.9	33,3	33,3	1,1
<i>Pherusa eruca</i>				16,7±11.8						16,7±11.8			33,3	16,7	1,1
<i>Syllis</i> sp						16,7±5.9				8,3±5.9			25,0	16,7	0,8
<i>Armandia cirrhosa</i>	8,3±5.9									8,3±5.9			16,7	16,7	0,5
<i>Fimbriosthenelais minor</i>				16,7±11.8									16,7	8,3	0,5

<i>Exogone (exogone)</i>									
<i>rostrata</i>		16,7±11.8					16,7	8,3	0,5
Cirratulidae	8,3±5.9					8,3±5.9	16,7	16,7	0,5
<i>Pectinaria (Lagis)</i>									
<i>koremi</i>				8,3±5.9		8,3±5.9	16,7	16,7	0,5
<i>Eunice harassii</i>				8,3±5.9			8,3	8,3	0,3
Goniada sp.						8,3±5.9	8,3	8,3	0,3
<i>Phyllodoce (Anaitides)</i>									
<i>mucosa</i>	8,3±5.9						8,3	8,3	0,3
<i>Pterocirrus</i>									
<i>macroceros</i>				8,3±5.9			8,3	8,3	0,3
<i>Chrysopetalum debile</i>		8,3±5.9					8,3	8,3	0,3
<i>Acanthicolepis</i>									
<i>asperrima</i>						8,3±5.9	8,3	8,3	0,3
<i>Syllis gerlachi</i>						8,3±5.9	8,3	8,3	0,3
<i>Syllis variegata</i>						8,3±5.9	8,3	8,3	0,3
<i>Arandia</i>									
<i>polyophthalma</i>						8,3±5.9	8,3	8,3	0,3
<i>Syllis corallicola</i>						8,3±5.9	8,3	8,3	0,3
<i>Arabella iricolor</i>				8,3±5.9			8,3	8,3	0,3

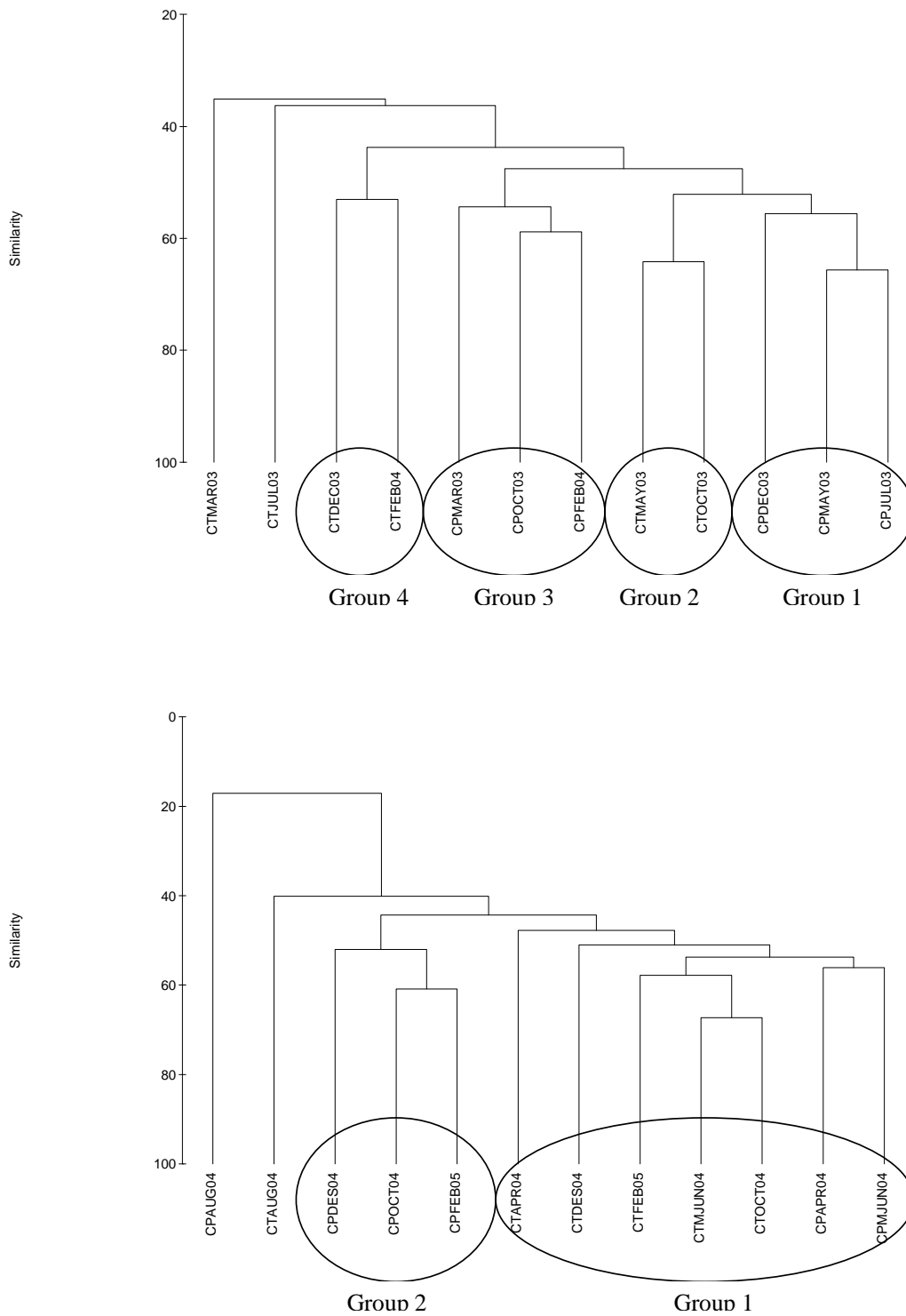

Figure 4: Clusters representation of the polychaete assemblage in first sampling year (A) and second sampling year (B).

Table 3: ANOSIM differences and SIMPER dissimilarity values between polychaete assemblages between *Caulerpa prolifera* and *C. taxifolia*

ANOSIM					CP03-CP04	CT03-CT04	CP03-CT0-3	CP04-CT04
Global R					0.341	-0.072	0.278	0.106
P					0.004	0.738	0.015	0.117
SIMPER	AA. CP03	AA CP04	AA CT 3	AA CT04	Contr. DS	Contr. DS	Contr. DS	Contr. DS
<i>Neanthes agulhana</i>	61.11	90.28	6.94	23.61	15.43	4.92	13.70	12.18
Terebellidae	29.17	25.00	6.94	23.61	5.24	5.24	6.30	4.80
<i>Pectinaria (Lagis) koremi</i>	18.06	1.39			3.67		4.95	
<i>Hyalinoecia bilineata</i>	18.06	29.17	77.78	20.83	7.78	18.79	14.74	8.82
<i>Sphaerosyllis austriaca</i>	19.44	2.78	2.78	5.56	5.87	1.94	4.94	3.82
<i>Arabella bicolor</i>	11.11	16.67		1.39	1.99		2.97	3.22
<i>Lumbrineris gracilis</i>	12.50	19.44	4.17	4.17	4.96	1.97	3.53	4.19
<i>Pholoe inornata</i>	11.11	1.39	1.39	5.56	2.51	1.64	3.06	1.04
<i>Syllis</i> sp.	9.72	2.78	2.78		2.15		2.86	
<i>Eunice vittata</i>	8.33	9.72	8.33	5.56	1.94	3.02	2.35	1.98
<i>Polyophthalmus pictus</i>	6.94	20.83	11.11	12.50	3.56	3.57	2.45	4.12
<i>Lumbrineris latreilli</i>	31.94	12.50	13.89	13.89	6.64	4.02	8.06	3.12
Capitellidae	6.94	11.11	20.83	26.39	2.17	6.42	3.88	4.66
Maldanidae	9.72	16.67	4.17	6.94	3.17	2.36	2.84	2.87
<i>Pelogenia arenosa</i>	5.56	15.28	4.17	13.89	2.52	3.41	2.06	2.74
Sabellidae	2.78	31.94	4.17	5.56	4.53	1.87	1.42	4.82
<i>Glycera</i> sp.		9.72			1.70			1.78
<i>Nematonereis unicornis</i>	4.17	9.72	12.50	13.89	1.74	3.90	3.19	2.48
Paraonidae		11.11	4.17	8.33	1.89	2.38		2.44
<i>Sphaerosyllis pirifera</i>	1.39	20.83		6.94	3.17	2.77	1.53	3.79
<i>Harmothoe spinifera</i>		4.17	1.39	16.17		5.41		3.55
<i>Lysidice ninetta</i>	6.94	2.78	5.56	12.50	1.63	4.16	1.87	2.88
Cirratulidae	4.17	6.94	1.39	1.39	1.49		1.17	1.14
<i>Exogone (exogone) rostrata</i>		9.72			1.33			1.38
<i>Platynereis dumerilii</i>	4.17	4.17		8.33	1.25	2.09		1.76
<i>Neanthes caudata</i>	1.39	4.17			0.93			
<i>Sthenelais boa</i>	4.17	1.39	2.78	6.94	0.93	2.04		1.54
<i>Pherusa eruca</i>	2.78		2.78	1.28		1.84	1.27	1.28
<i>Syllis garciai</i>	4.17	2.78	1.39	2.78		1.69	1.17	0.92
<i>Pontogenia chrysocoma</i>		2.78	2.78	5.56		2.24		1.25
<i>Nereis falsa</i>		4.17						0.94
<i>Lumbrineris impatiens</i>		1.39	1.39	4.17		1.31		0.93
<i>Lumbrineropsis paradoxa</i>			1.39	4.17		1.14		
Average Dissimilarity between meadows pairs					71.96	65.32	72.34	72.13

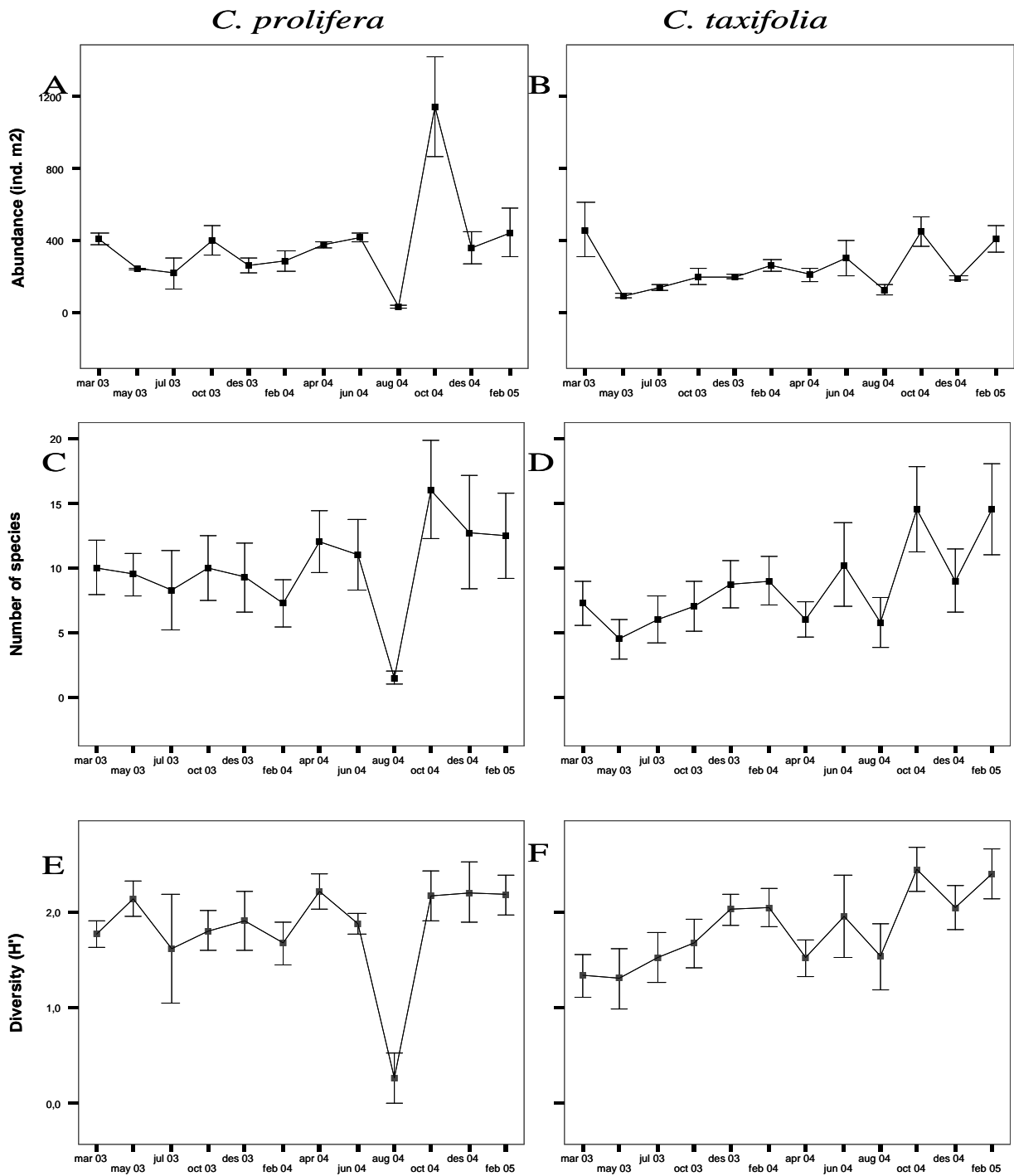

Figure 5: Seasonal changes in the polychaete descriptors in both sampling years for *Caulerpa prolifera* and *C. taxifolia*.

Table 4: Three way nested ANOVA of the polychaete descriptors between *Caulerpa prolifera* and *C. taxifolia*. * means $p < 0.05$, ** means $p < 0.01$ and *** means $p < 0.001$

Source of variation	Degr of freedom	Abundance	Species number	Diversity
		MS	MS	MS
Meadow	1	396123***	51.042	0.000
Year	1	278067**	140.167**	0.674
Month(Meadow*year)	21	167829***	41.702	0.898***
Residual	72	28866	25.694	0.248

Table 5: Three way nested ANOVA of the polychaete main trophic guilds between *Caulerpa prolifera* and *C. taxifolia*. * means $p < 0.05$, ** means $p < 0.01$ and *** means $p < 0.001$

Source of variation	Degr of freedom	Carnivores	Deposit feeders	Filter feeders	Herbivores	Omnivores
		MS	MS	MS	MS	MS
Meadow	1	33750.0**	1157.0	4178.2*	20416.7**	74074***
Year	1	20416.7*	741.0	6122.7**	10416.7**	31296**
Month (Meadow*year)	21	9131.4**	25489.0***	2736.4***	10745.1***	24920***
Residual	72	4265.0	6875	856.5	1770.8	4079.9

Trophic guilds

There were significant differences between *Caulerpa prolifera* and invasive *C. taxifolia* for all trophic guilds, excluding deposit feeders (Fig 4). For carnivores, filter feeders, omnivores and herbivores abundances were higher in *C. prolifera* than *Posidonia oceanica*. Additionally, there were significant differences in polychaete trophic guilds between sampling years and seasonality (Table 5).

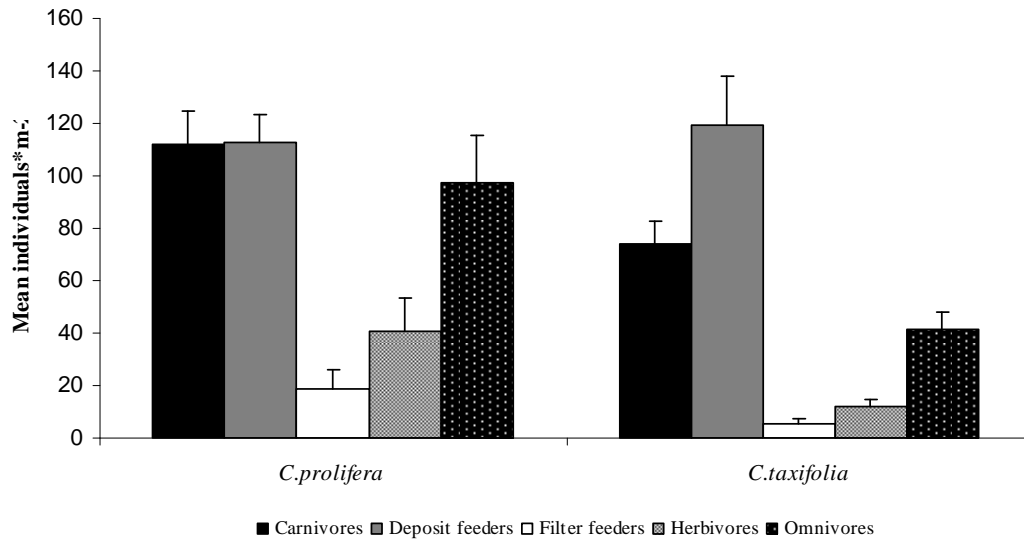

Figure 6: Polychaete abundances expressed as ind/m² per trophic guilds for *Caulerpa prolifera* and *C. taxifolia*

Discussion

Habitat structure, or the fraction of dead mat composed of *Posidonia oceanica*, was quite similar in both *Caulerpa* species. However, the higher yearly biomass of *C. prolifera* induced a higher sedimentation rate and resulted in a smaller average grain size than in *C. taxifolia*. During the winter months, *C. taxifolia* exhibited low biomass, and the sediment retention by fronds and stolons was consequently lower. The vegetation coverage of the *Caulerpa* substrate resulted in organic matter enrichment and reduction of mean grain size (Sanchez-Moyano et al. 2001a; Sanchez-Moyano et al. 2001b). These differences were constant for both sampling years and do not explain the differences in polychaete assemblages between years.

The structures of the polychaete communities inhabiting *Caulerpa* mats were quite similar between *C. prolifera* and the invasive *C. taxifolia*. Dominant, common species were often found in both habitats. The most abundant species in *Caulerpa* mats were *Neanthes agulhana* in *C. prolifera* and *Hyalinoecia bilineata* in *C. taxifolia*. Both species were abundant and frequent in both *Caulerpa* mats. The nereid *N. agulhana* is typical to shallow infralittoral locations and prefers calm waters (Viétez et al. 2004). *H. bilineata* is a common species in *P. oceanica* seagrass rhizomes (Campoy 1982). In *C.*

prolifera mats, the family Terebellidae (predominantly *Pista cretacea*) and the species *Sphaerosyllis austriaca* were also dominant. Both species are considered typical to *P. oceanica* seagrass meadows (Gambi et al. 1995; Gambi et al. 1998). The polychaete species composition described in this study is highly similar to that of *P. oceanica* seagrass meadows. Consequently, we must consider the effects of substrate and proximity of the sampling area of the seagrass meadow.

Polychaeta abundances and diversity did not show a clear seasonal trend, as observed in the results. In *Caulerpa prolifera*, dramatic fluctuations in polychaete abundance were due to a late summer peak in abundance of *Lumbrineris latreilli* (during the first sampling year) and *Neanthes agulhana* (during the second sampling year). This abundance peak was preceded by low abundance and diversity (July 2003, August 2004). To explain these results, we considered the effects of vegetative substrate cover and structural habitat complexity on benthic faunal community composition (Edgar et al. 1994; Gambi et al. 1998; Sanchez-Jerez et al. 1999b). However, in *C. prolifera*, the period of greatest vegetative growth affected the diversity of the infauna community negatively (Sanchez-Moyano et al. 2001a). In this study, we considered only polychaete communities, and biomass was not found to affect polychaete abundance. However, during the second sampling year, polychaete diversity was positively correlated with *C. prolifera* biomass, indicating that greater *C. prolifera* biomass positively impacts polychaetes. Increased biomass of *Caulerpa* favours stabilisation and organic enrichment of the substrate, and it may induce anoxic conditions that affect certain taxa negatively, including bivalves (Sanchez-Moyano et al. 2001b). However, some polychaete species could increase in abundance with high algal biomass, particularly those species associated with organically enriched sediments (Cardoso et al. 2004).

Polychaete abundance was lower in *C. taxifolia*, than in *C. prolifera*. Complex seasonal abundance changes were observed in mats of both species. During the first sampling year, *Caulerpa* biomass was found to impact polychaete species number and diversity negatively. This correlation was not found during the second sampling year. This negative correlation indicates that the vegetative substrate cover does not necessarily favour particular polychaetes. During the first sampling year, greater *C. taxifolia* biomass was recorded, and this may correspond to the negative effect of high *Caulerpa* biomass previously described by Sanchez-Moyano (2001b). Despite the similar polychaete species compositions of the two *Caulerpa* species, *C. taxifolia*

species composition was typical from *P. oceanica* seagrass meadows. *C. prolifera* has long been endemic to the Western Mediterranean, and several polychaete species, including *Neanthes agulhana*, *Pista cretacea* and *Pectinaria (Lagis) koremi*, have developed mechanisms to thrive in a *C. prolifera* mats. *C. taxifolia* is a recent introduction to the Balearic coastal waters, and the invertebrate community composition is likely related to factors such as nearby habitat and substrate type more than to the species of *Caulerpa*.

The *Caulerpa* species are characterised by the production of toxic metabolites such as caulerpenyne (Jung et al. 2002) that prevent from herbivorism and epiphytism of fronds and stolons. Environmental caulerpenyne could also affect indirectly fauna living inside *Caulerpa* mats (Sureda et al. 2006). Despite the fact that *C. prolifera* produces higher levels of caulerpenyne than *C. taxifolia* (Sureda et al. 2006), the long period of coexistence has allowed several species to develop mechanisms of avoiding the damage associated with this toxic compound. This fact may also be due to the amount of time since substrate colonisation of the two *Caulerpa* mats polychaete species composition, abundances and diversity.

The analysis of the trophic guild differences of *C. prolifera* and *C. taxifolia* showed that only the presence of deposit-feeder polychaetes was similar between *C. prolifera* and *C. taxifolia*. Other trophic guilds showed greater abundance in *C. prolifera*. The abundance of the deposit feeders *Terebellidae*, *Capitellidae* and *Onuphidae (Hyalionecia bilineata)* was high in both *Caulerpa* mats. Caulerpales show enhanced vegetative growth and capacity to trap sediment (Piazzi et al. 2005). This enhanced ability to trap sediment induces an increased organic load (Sanchez-Moyano et al. 2001a) that favours the presence of deposit feeders in both *Caulerpa* mats.

Conclusions

Our primary finding is that the differences in polychaete communities between an established *C. prolifera* mat and invasive *C. taxifolia* mat are driven by differences in abundance of species found in both mats. *C. prolifera* mats showed higher polychaete abundance and diversity than that found in *C. taxifolia* mats. The long-term colonisation of *C. prolifera* will change the abiotic parameters of substratum and will induce changes in the polychaete community. The recent introduction of and low *C. taxifolia* biomass

during the first year indicates that the habitat is unstable since *C. taxifolia* communities decline during the winter. In *C. taxifolia* mats, the polychaete community was highly influenced by the nearby polychaete *P. oceanica* community, with *P. oceanica* polychaete species extraordinarily abundant. The expansion and evolution of polychaete assemblages in *C. taxifolia* must be monitored since the actual stage of colonisation is unclear, and the invasive effects *Caulerpa* must be further studied.

Acknowledgements

This research was funded by the Science and Technology Ministry (Plan Nacional I+D (REN2002-00701/MAR). The first author was funded by postgraduate research grant I3P FSE. We are most grateful to J. Terrados and N. Marbà for their help during sample collection and *Caulerpa* mat characterization.

References

- Amade P, Lemee R (1998) Chemical defence of the Mediterranean alga *Caulerpa taxifolia*: variations in caulerpenyne production. *Aquatic Toxicology* 43: 287-300
- Antoniadou C, Chintiroglou C (2006) Trophic relationships of polychaetes associated with different algal growth forms. *Helgoland Marine Research* 60: 39-49
- Argyrou M, Demetropoulos A, Hadjichristophorou M (1999) Expansion of the macroalga *Caulerpa racemosa* and changes in softbottom macrofaunal assemblages in Moni Bay, Cyprus. *Oceanologica Acta* 22: 517-528
- Balata D, Piazzì L, Cinelli F (2004) A comparison among assemblages in areas invaded by *Caulerpa taxifolia* and *C. racemosa* on a subtidal Mediterranean rocky bottom. *Marine Ecology-Pubblicazioni Della Stazione Zoologica Di Napoli I* 25: 1-13
- BellanSantini D, Arnaud PM, Bellan G, Verlaque M (1996) The influence of the introduced tropical alga *Caulerpa taxifolia*, on the biodiversity of the Mediterranean marine biota. *Journal of the Marine Biological Association of the United Kingdom* 76: 235-237

- Boudouresque CF, Lemee R, Mari X, Meinesz A (1996) The invasive alga *Caulerpa taxifolia* is not a suitable diet for the sea urchin *Paracentrotus lividus*. *Aquatic Botany* 53: 245-250
- Boudouresque CF, Verlaque M (2002) Biological pollution in the Mediterranean Sea: invasive versus introduced macrophytes. *Marine Pollution Bulletin* 44: 32-38
- Brito MC, Martin D, Nunez J (2005) Polychaetes associated to a *Cymodocea nodosa* meadow in the Canary Islands: assemblage structure, temporal variability and vertical distribution compared to other Mediterranean seagrass meadows. *Marine Biology* 146: 467-481
- Buia MC, Gambi MC, Terlizzi A, Mazzella L (2001) Colonization of *Caulerpa racemosa* along the southern Italian coast: I. Distribution, phenological variability and ecological role. In: Gravez V, Ruitton S, Boudouresque CF, Le Direac'h L, Meinesz A, G. S (eds) Fourth International Workshop on *Caulerpa taxifolia*. GIS Posidonie, France, pp 352-360
- Campoy A (1982) Fauna de Anélidos Poliquetos de la Península Ibérica. Universidad de Navarra, Navarra
- Cardoso PG, Pardal MA, Raffaelli D, Baeta A, Marques JC (2004) Macroinvertebrate response to different species of macroalgal mats and the role of disturbance history. *Journal of Experimental Marine Biology and Ecology* 308: 207-220
- Ceccherelli G, Piazzini L, Balata D (2002) Spread of introduced *Caulerpa* species in macroalgal habitats. *J Exp Mar Biol Ecol* 280: 1-11.
- Devillele X, Verlaque M (1995) Changes and Degradation in a *Posidonia oceanica* Bed Invaded by the Introduced Tropical Alga *Caulerpa taxifolia* in the North-Western Mediterranean. *Botanica Marina* 38: 79-87
- Der Hartog, C (1994) Suddocation of a littoral *Zoostera* bed by *Enteromorpha radiata*. *Aquatic Botany* 47: 21-28
- Dumay O, Pergent G, Pergent-Martini C, Amade P (2002) Variations in caulerpenyne contents in *Caulerpa taxifolia* and *Caulerpa racemosa*. *Journal of Chemical Ecology* 28: 343-352
- Edgar GJ, Shaw C, Watson GF, Hammond LS (1994) Comparisons of Species Richness, Size-Structure and Production of Benthos in Vegetated and Unvegetated Habitats in Western-Port, Victoria. *Journal of Experimental Marine Biology and Ecology* 176: 201-226

- Fauchald K, Jumars P (1979) The diet of worms: a study of Polychaeta feeding guilds. *Oceanography and Marine Biological. An Annual Review* 17: 193-284
- Galil BS (2007) Loss or gain? Invasive aliens and biodiversity in the Mediterranean Sea. *Marine Pollution Bulletin* 55: 314-322
- Gambi MC, Conti G, Bremec CS (1998) Polychaete distribution, diversity and seasonality related to seagrass cover in shallow soft bottoms of the Tyrrhenian Sea (Italy) 62: 1-17
- Gambi MC, Giangrande A, Martinelli M, Chessa LA (1995) Polychaetes of a *Posidonia oceanica* Bed Off Sardinia (Italy) - Spatiotemporal Distribution and Feeding Guild Analysis. *Scientia Marina* 59: 129-141
- Givernaud TJ, Cosson J, Givernaud-Mouradi A (1991) Etudes des populations de *Sargassum muticum* sur les cores de Basse, Normandies (France). In: Elliot M, Ducrotoy JP (eds) 19th Symposium Estuarines and Coast: Spatial and temporal Intercomparison. *International Symposium Series*, pp 129-132.
- Gollasch S (2006) Overview on introduced aquatic species in European navigational and adjacent waters. *Helgoland Marine Research* 60: 84-89
- Jung V, Thibaut T, Meinesz A, Pohnert G (2002) Comparison of the wound-activated transformation of caulerpenyne by invasive and non-invasive *Caulerpa* species of the Mediterranean. *Journal of Chemical Ecology* 28: 2091-2105
- MacDougall AS, Turkington R (2005) Are invasive species the drivers or passengers of change in degraded ecosystems? *Ecology* 86: 42-55
- Mack RN, Simberloff D, Lonsdale WM, Evans H, Clout M, Bazzaz FA (2000) Biotic invasions: Causes, epidemiology, global consequences, and control. *Ecological Applications* 10: 689-710
- Martin D, Pinedo S, Sarda R (2000) Distribution patterns and trophic structure of soft-bottom polychaeta assemblages in north-western Mediterranean shallow-water bay. *Ophelia* 53: 1-17
- Meinesz A, Belsher T, Thibaut T, Antolic B, Mustapha KB, Boudouresque CF, Chiaverini D, Cinelli F, Cottalorda JM, Djellouli AS, El Abed A, Orestano C, Grau AM, Ivesa L, Vaugelas I, Zavodnik N, Zuljevic A (2001) The introduced green alga *Caulerpa taxifolia* continues to spread in Mediterranean. *Biological Invasions* 3: 201-210
- Meinesz A, Hesse B (1991) Introduction of the Tropical Alga *Caulerpa taxifolia* and Its Invasion of the Northwestern Mediterranean. *Oceanologica Acta* 14: 415-426

- Montefalcone M, Morri C, Peirano A, Albertelli G, Bianchi C N (2007) Substitution and phase shift within the *Posidonia oceanica* seagrass meadows of NW Mediterranean Sea. *Estuarine and Coastal Shelf Science* 75: 63-71.
- Occhipinti-Ambrogi A, Savini D (2003) Biological invasions as a component of global change in stressed marine ecosystems. *Marine Pollution Bulletin* 46: 542-551
- Pandolfo A, Chemello R (1995) Prime nota sulla malacofauna associata a *Caulerpa racemosa* nella Baia di Santa Panagia (Sicilia orientale). *Biologia Marina Mediterranea* 2: 649-651
- Pedrotti ML, Marchi B, Lemee R (1996) Effects of *Caulerpa taxifolia* secondary metabolites on the embryogenesis, larval development and metamorphosis of the sea urchin *Paracentrotus lividus*. *Oceanologica Acta* 19: 255-262
- Pesando D, Lemee R, Ferrua C, Amade P, Girard JP (1996) Effects of caulerpenyne, the major toxin from *Caulerpa taxifolia* on mechanisms related to sea urchin egg cleavage. *Aquatic Toxicology* 35: 139-155
- Piazzì L, Balata D, Ceccherelli G, Cinelli F (2005) Interactive effect of sedimentation and *Caulerpa racemosa* var. *cylindracea* invasion on macroalgal assemblages in the Mediterranean Sea. *Estuarine Coastal and Shelf Science* 64: 467-474
- Pou S, Ballesteros E, Delgado O, Grau AM, Riera F, Weitzmann B (1993) Sobre la presencia del alga *Caulerpa taxifolia* (Vahl) C. Agardh (Caulerpales, Chlorophyta) en aguas costeras de Mallorca. *Bolletí Societat d'Història Natural de les Illes Balears* 36: 83-90
- Sakai AK, Allendorf FW, Holt JS, Lodge DM, Molofsky J, With KA, Baughman S, Cabin RJ, Cohen JE, Ellstrand NC, McCauley DE, O'Neil P, Parker IM, Thompson JN, Weller SG (2001) The population biology of invasive species. *Annual Review of Ecology and Systematics* 32: 305-332
- Sanchez-Jerez P, Cebrian CB, Espla AAR (1999) Comparison of the epifauna spatial distribution in *Posidonia oceanica*, *Cymodocea nodosa* and unvegetated bottoms: Importance of meadow edges 20: 391-405
- Sanchez-Moyano JE, Estacio FJ, Garcia-Adiego EM, Garcia-Gomez JC (2001a) Effect of the vegetative cycle of *Caulerpa prolifera* on the spatio-temporal variation of invertebrate macrofauna. *Aquatic Botany* 70: 163-174
- Sanchez-Moyano JE, Garcia-Adiego EM, Estacio FJ, Garcia-Gomez JC (2001b) Influence of the density of *Caulerpa prolifera* (Chlorophyta) on the composition

- of the macrofauna in a meadow in Algeciras Bay (southern Spain). *Ciencias Marinas* 27: 47-71
- Sanchez-Moyano JE, Moreno D, Rueda JL, Garcia-Raso JE, Salas C, Gofas S (2004) Las praderas de *Caulerpa prolifera*. In: Ambiente CdM (ed) Praderas y bosques marinos de Andalucía. Junta de Andalucía, Sevilla, pp 239-249
- Streftaris N, Zenetos A (2006) Alien Marine Species in the Mediterranean - th 100 'Worst Invasives' and their impact. *Mediterranean Mar Sci* 7/1: 87-118.
- Sureda A, Box A, Deudero S, Pons A (2008) Reciprocal effects of caulerpenyne and intense herbivorism on the antioxidant response of *Bittium reticulatum* and *Caulerpa taxifolia*. *Ecotoxicology and Environmental Safety* in press: doi:10.1016/j.ecoenv.2007.1012.1007
- Sureda A, Box A, Ensenat M, Alou E, Tauler P, Deudero S, Pons A (2006) Enzymatic antioxidant response of a labrid fish (*Coris julis*) liver to environmental caulerpenyne. *Comparative Biochemistry and Physiology C-Toxicology & Pharmacology* 144: 191-196
- Verlaque M, Afonso-Carrillo J, Gil-Rodriguez MC, Durand C, Boudouresque CF, Le Parco Y (2004) Blitzkrieg in a marine invasion: *Caulerpa racemosa* var. *cylindracea* (Bryopsidales, Chlorophyta) reaches the Canary Islands (north-east Atlantic). *Biological Invasions* 6: 269-281
- Viétez JM, Alós C, Parapar J, Besteiro C, Moreira J, Núñez J, Laborda AJ, San Martín G (2004) Annelida Polychaeta I. Consejo Superior de Investigaciones Científicas, Madrid
- Zenetos A, Gofas S, Russo GF, Templado J (2003) CIESM Atlas of Exotic Species in the Mediterranean, Volume 3: Mollusc. CIESM Publishers, Monaco.

4.4 Resumen de las comunidades de poliquetos

Resumen del estudio “Seagrass polychaete assemblages changes after invasion by *Caulerpa racemosa* var. *cylindracea*: community structure and trophic guilds “

- En *Caulerpa racemosa* var. *cylindracea* se ha encontrado mayor abundancia acumulada de poliquetos (durante 1 año de muestreo bimensual) con 1863 ejemplares respecto a *Posidonia oceanica* con 1475 individuos contabilizados. El número de especies de poliquetos es similar entre ambos sustratos (43 en *Caulerpa*, 44 en *Posidonia*). La abundancia de poliquetos muestra un aumento como previamente había descrito Argyrou *et al* (1999).
- La composición de especies de poliquetos entre *Posidonia oceanica* y *Caulerpa racemosa* var. *cylindracea* es muy similar. Las especies más abundantes en *C. racemosa* var. *cylindracea* son *Neanthes agulhana*, *Polyopthalmus pictus*, *Lumbrineris latreilli* y *Arabella bicolor* que están también presentes en *P. oceanica*. Las especies *Nematoneis unicornis*, *Hyalionecia bilineata*, *Lysidice ninetta* y *Eunice vittata*, son las más abundantes en *P. oceanica*, también presentes en *C. racemosa* var. *cylindracea*. Por lo tanto las diferencias entre praderas están fundamentalmente asociadas a las abundancias de poliquetos presentes en ambas.
- Las especies encontradas en *C. racemosa* var. *cylindracea* y *Posidonia oceanica* se caracterizan por ser especies propias típicas de fondos blandos (Gambi *et al.* 1995; Gambi *et al.* 1998; Brito *et al.* 2005).
- La biomasa de *Caulerpa racemosa* var. *cylindracea* está positivamente correlacionada con las abundancias, número de especies y diversidad de poliquetos. Estos resultados destacan la importancia de la cobertura del sustrato por parte de la caulerpal. Los resultados obtenidos muestran mayor abundancia y diversidad de poliquetos en verano-otoño (mayor biomasa de *Caulerpa*, respecto a las muestras de invierno (sustrato sin cobertura por *C. racemosa* var. *cylindracea*). Este resultado se ve reforzado por las menores abundancias y diversidad de especies que

en *Posidonia* respecto *Caulerpa* encontrado durante el periodo sin biomasa aparente de *Caulerpa racemosa* (solo mata de *Posidonia*).

- La invasión de *Caulerpa racemosa* var. *cylindracea* en zonas donde previamente había praderas de *Posidonia oceanica* no supone cambios en las principales estrategias tróficas de poliquetos, aunque se observa una tendencia al incremento de especies carnívoras y reducción de detritívoras.
- En la situación actual de invasión, *Caulerpa racemosa* var. *cylindracea* no forma praderas monoespecíficas, por lo tanto, además de compartir sustrato con *Posidonia oceanica*, las especies de poliquetos móviles pueden desplazarse de la pradera de *P. oceanica* hacia la *Caulerpa* y viceversa.

Resumen del estudio “Seagrass polychaete assemblages differences between invasive *Caulerpa taxifolia* and established *C. prolifera*: community structure and trophic guilds”

- El número de especies de poliquetos encontradas es similar en ambas caulerpales, (40 en *Caulerpa prolifera* y 36 en *C. taxifolia*) aunque con diferentes patrones estacionales. Las abundancias de poliquetos son significativamente superiores en la zona de *C. prolifera*, con una abundancia acumulada de 4575 ejemplares, que en *C. taxifolia* con una abundancia acumulada de 3033 ejemplares.
- Las especies más abundantes en *Caulerpa prolifera* son en orden de importancia *Neanthes agulhana*, *Sphaerosyllis austriaca*, *Hyalinoecia bilineata*, *Lumbrineris latreilli* y *Lumbrineris gracilis*.
- En la invasora *Caulerpa taxifolia* los poliquetos más abundantes son, en orden de importancia, *Hyalinoecia bilineata*, *Neanthes agulhana*, *Lumbrineris latreilli*, *Nematonereis unicornis* y *Polyophthalmus pictus*.
- Las especies dominantes y más frecuentes coinciden en ambas caulerpales, como es el caso de *Neanthes agulhana*, *Hyalinoecia bilineata*, *Lumbrineris gracilis* y

Lumbrineris latreilli entre otras. En general la mayoría de especies identificadas en el presente trabajo son especies típicas de fondos blandos colonizadas por *C. prolifera* (Sánchez-Moyano et al. 2001a; Sánchez-Moyano et al. 2001b) y de praderas de *Posidonia oceanica* (Gambi et al. 1995; Gambi et al. 1998; Brito et al. 2005).

- Las especies de poliquetos *Neanthes agulhana* (mayor abundancia en *Caulerpa prolifera*) y *Hyalionecia bilineata* (mayor abundancia en *C. taxifolia*), son las principales responsables de las diferencias entre las comunidades de poliquetos de ambas caulerpales.
- La comunidad muestreada de poliquetos presenta variaciones anuales. Los resultados del primer año muestran una clara diferenciación en la comunidad de poliquetos de *Caulerpa taxifolia* y *C. prolifera*, pero en el segundo año desaparecen. Esta variación es debida, en gran parte, al incremento de *Neanthes agulhana* en *C. taxifolia* y al descenso de *Hyalionecia bilineata* en *C. taxifolia* durante el segundo año (2004).
- El análisis de las estrategias tróficas muestra que el número de detritívoros es similar entre ambas caulerpales. Las otras estrategias tróficas muestran mayor abundancia para los carnívoros, herbívoros, filtradores y omnívoros en *Caulerpa prolifera*. Estas mayores densidades se asocian en general a la mayor abundancia de poliquetos en *C. prolifera*.
- El mayor tiempo de colonización del sustrato por parte de *Caulerpa prolifera* conlleva cambios en el hábitat, como es una textura del sedimento caracterizada por una menor granulometría. La comunidad de poliquetos en *C. prolifera* lleva más tiempo asociada al hábitat de esta caulerpal, desarrollando las adaptaciones necesarias. Por otro lado *C. taxifolia* es más reciente en los fondos de Baleares y además no coloniza grandes superficies ni presenta grandes biomásas. Por lo tanto la comunidad de poliquetos asociada muestra una gran influencia por parte de la comunidad de poliquetos de los rizomas de *Posidonia oceanica* y la pradera viva que rodea las zonas muestreadas.

Capítulo 5

CAMBIOS EN LAS COMUNIDADES DE INVERTEBRADOS. NUEVAS ESPECIES Y CITAS CHANGES IN INVERTEBRATES COMMUNITIES. NEW SPECIES AND RECORDS

Capítulo adaptado de :

Changes in the faunistic communities associated with the presence of green algae *Caulerpa* (2008). Box, A., Deudero, S. In prep.

A new species of *Nuuanu* (Amphipoda: Gammaridea: Melitidae) from shallow sandy bottoms of the Balearic Islands (W Mediterranean) (2006). Jaume, D and Box A. Scientia Marina, **70** 735-747.

Ocurrence of *Automate branchialis* (Holthuis &Gottlieb, 1959) (Decapoda, Alpheidae) in the Balearic Islands (Western Mediterranean Sea) (2007). Box, A., Guerao, G., Abellò, P. Deudero, S. Crustaceana, **80** 495-501.

5.1 Introducción al capítulo.

En el presente capítulo se realiza una síntesis de los resultados de la abundancia y diversidad de especies obtenidos para los grupos faunísticos estudiados en detalle (crustáceos, moluscos y poliquetos) además de incluir sipuncúlidos y equinodermos, en los hábitats generados por *Caulerpa prolifera*, *C. taxifolia*, *C. racemosa* var. *cylindracea* y *Posidonia oceanica*. Moluscos, decápodos y poliquetos presentan en mayor o menor medida un cambio en sus abundancias y composición de especies con la presencia de algas del género *Caulerpa*. Las diferencias en abundancias de los principales filums nos permiten comprender cuales son más lábiles para adaptarse al hábitat generado por especies invasoras. Los trabajos publicados hasta el momento no muestran un patrón común sobre los efectos de las caulerpales sobre la fauna. Se han observado importantes reducciones en diversidad y abundancias de especies de invertebrados en *C. taxifolia* (Bellan-Santini et al. 1996). En *C. racemosa* se ha obtenido que los moluscos reducen sus abundancias y los poliquetos las incrementan (Argyrou et al. 1999). Aunque Buia et al. (2001) destaca el incremento de la diversidad y abundancias de moluscos en zonas invadidas por *C. racemosa*.

Las muestras analizadas de macrofauna y sedimento en el presente capítulo han sido recogidas mediante un cuadrante 20 x 20 insertado 5 cm en el sedimento. Las diferencias en abundancias se han analizado para los cuatro hábitats. La importancia de los diferentes filums en cada uno de los hábitats también ha sido estudiada.

Las especies identificadas en *Caulerpa* spp. y *Posidonia* han sido listadas para evaluar las diferencias en composición específica por filum y así comprender si la presencia de especies invasoras implica una reducción de la diversidad y que especies son comunes en caulerpeles y entre caulerpales y *Posidonia oceanica*. Estos listados faunísticos son además de gran importancia para incrementar el conocimiento de la fauna de invertebrados en las Islas Baleares en fondos poco profundos.

Durante el desarrollo del presente trabajo han sido encontradas tres especies previamente no descritas como son el anfípodo *Nuanuu beatricensis*, *Leptocheila dubia* agg. sp. nov (en proceso de descripción) y una nueva especies de isópodo (en proceso de descripción). Se ha incluido en la presente tesis la descripción de la especies *Nuanuu beatricensis*.

Además se ha realizado una descripción de la especie *Automate branchialis*, previamente considerada como posible migrante lessepsiana, pero descrita en el presente capítulo como propia del Mediterráneo.

5.2 Changes in the faunistic communities associated with the presence of green algae *Caulerpa*

Introducción

En el presente apartado se analizan los resultados obtenidos sobre las comunidades bentónicas muestreadas en *Caulerpa* y *Posidonia oceanica* comparándose la abundancia de los diferentes grupos taxonómicos.

El análisis de la comunidad se basa en grandes grupos, basados en las categorías taxonómicas de Filum, Clase y Orden como se especifica a continuación:

- Filum Mollusca
- Clase Polychaeta
- Orden Decapoda
- Orden Tanaidacea
- Orden Amphipoda
- Orden Isopoda
- Phylum Sipunculida
- Filum Echinodermata

Material y métodos

Las muestras, localidades y metodología de estudio de este capítulo son coincidentes con los capítulos anteriores. Debido al procesado, las correspondientes al año 2003 no se consideran ya que los anisópodos no fueron correctamente separados por error en el procesado de las muestras. Por ello dentro de esta sección solo se considerarán las muestras comprendidas entre febrero 2004 y febrero 2005.

Resultados

Los poliquetos son el grupo que presenta mayor porcentaje de contribución en los cuatro hábitats estudiados. En *Posidonia oceanica* suponen el 50 % del total de ejemplares recogidos. En *Caulerpa prolifera*, junto a los poliquetos, los moluscos son los más importantes a la hora de caracterizar el hábitat (porcentaje contribución 38%) (Fig. 1).

En las invasoras *Caulerpa racemosa* var. *cylindracea* y *C. taxifolia* disminuye el porcentaje de poliquetos respecto a *Posidonia oceanica* y aumentan decápodos, anfípodos y moluscos (Fig. 1).

Las abundancias de los diferentes órdenes de crustáceos sólo muestran diferencias significativas entre *Caulerpa racemosa* var. *cylindracea* y *Posidonia oceanica* para anisópodos y decápodos. Ambos con abundancias significativamente superiores en *C. racemosa* var. *cylindracea* (ANOVA $p < 0.05$) (Fig. 2).

Los moluscos presentan abundancia significativamente superiores en *Caulerpa prolifera* respecto a las otras caulerpales y *Posidonia oceanica* (ANOVA, $p < 0.05$) (Fig. 3).

Los poliquetos no presentan diferencias significativas entre las caulerpales y *Posidonia oceanica* (Fig. 4). Las menores abundancias de equinodermos las encontramos en *C. prolifera*, siendo sus abundancias significativamente superiores en *C. taxifolia* respecto a *C. prolifera* (ANOVA $p < 0.05$) (Fig. 5).

Los resultados del SIMPER muestran que la mayor abundancia de moluscos y poliquetos en *Caulerpa prolifera* son las responsables de sus diferencias respecto a las otras caulerpales y *Posidonia oceanica*. La comunidad de *C. prolifera* y *P. oceanica* son las comunidades estudiadas con mayores diferencias (Tabla 1). En *C. racemosa* var. *cylindracea* la mayor abundancia de los crustáceos de los órdenes anfípodos y decápodos son los principales causantes de sus diferencias con *P. oceanica*. La comunidad de invertebrados en *C. taxifolia* tiene abundancias intermedias entre *C. racemosa* var. *cylindracea* y *P. oceanica* no diferenciándose significativamente de ninguna de ellas (Tabla 1).

Tabla 1: Análisis SIMPER y ANOSIM de las comunidades de Caulerpales y *Posidonia* para establecer las principales diferencias entre los grupos estudiados. CP significa *Caulerpa prolifera*, CT *Caulerpa taxifolia*, CR *Caulerpa racemosa* y PO *Posidonia oceanica*.

	CP-PO	CT-PO	CR-PO	CP-CT	CP-CR	CT-CR
SIMPER						
Amphipoda	7.78	18.53	19.65	11.37	15.39	23.10
Anisopoda		6.69	7.99		4.89	6.70
Decapoda	7.08	17.86	23.67	10.30	17.13	22.14
Isopoda		6.29		3.73		5.33
Mollusca	40.60	14.70	20.62	34.44	28.71	16.44
Polychaeta	36.19	30.86	19.82	32.35	28.08	20.83
Equinoderma						
Sipunculida						
Average dissimilarity	53.98%	39.49%	49.17%	42.47%	44.84%	36.22%
ANOSIM						
Global R	0.477	0.229	0.469	0.337	0.311	0.184
Sig. Level	0.004	0.039	0.007	0.005	0.010	0.012

Posidonia oceanica

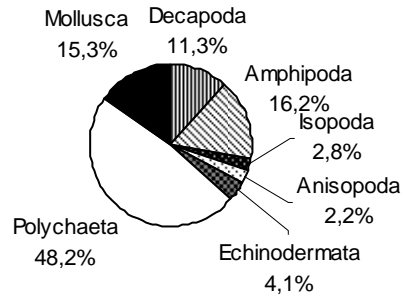

Caulerpa prolifera

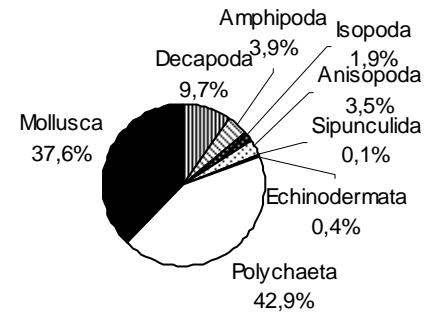

Caulerpa taxifolia

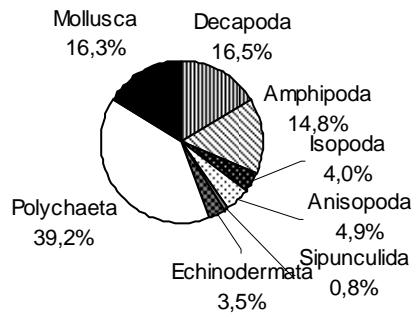

Caulerpa racemosa var. cylindracea

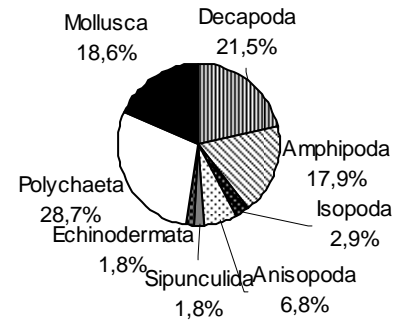

Fig 1: Porcentaje de contribución de la abundancia de los diferentes grupos faunísticos identificados para *Caulerpa* spp y *Posidonia oceanica*.

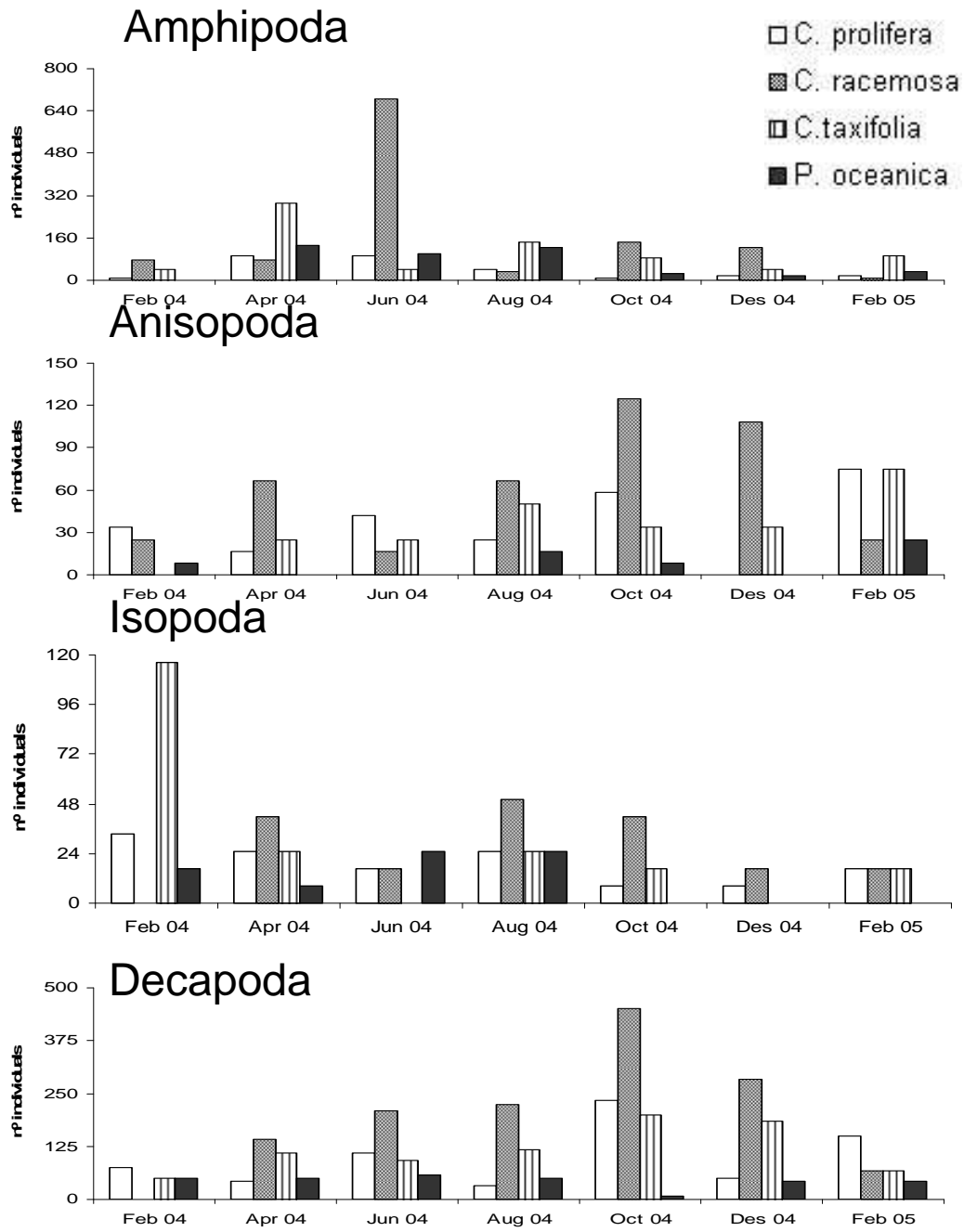

Fig 2: Cambios temporales en la abundancia de crustáceos en *Caulerpa* spp. y *Posidonia oceanica*.

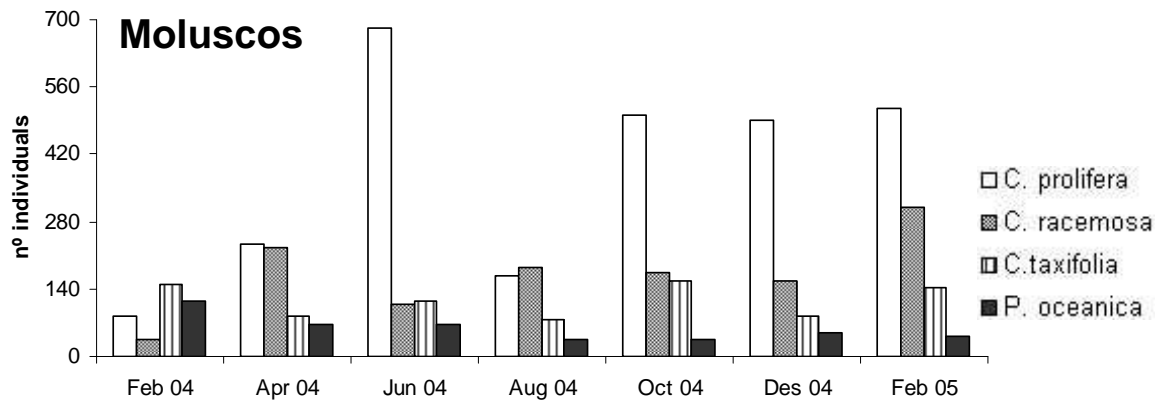

Fig 3: Cambios temporales en la abundancia de moluscos en *Caulerpa* spp. y *Posidonia oceanica*.

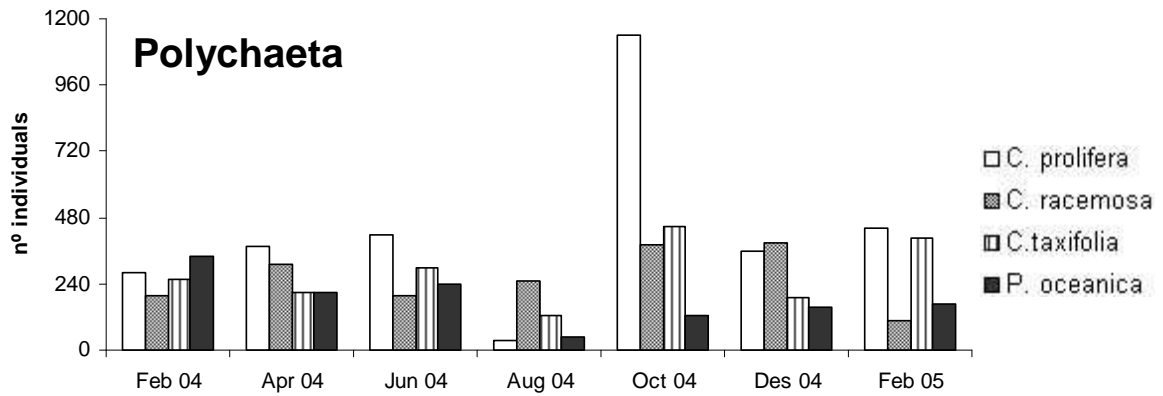

Fig 4: Cambios temporales en la abundancia de poliquetos en *Caulerpa* spp. y *Posidonia oceanica*.

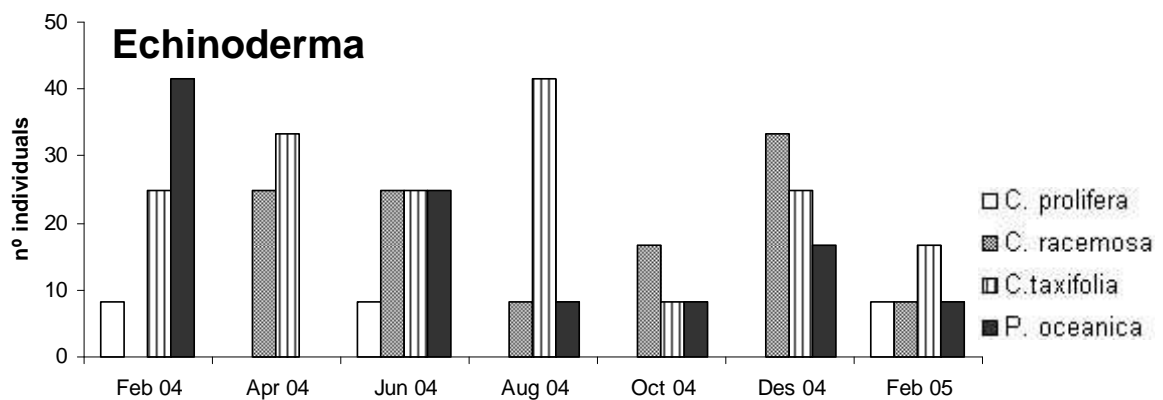

Fig 5: Cambios temporales en la abundancia de equinodermos en *Caulerpa* spp. y *Posidonia oceanica*.

A lo largo del estudio se han identificado un total de 72 especies de poliquetos, 53 de moluscos, 68 crustáceos (33 decápodos, 33 anfípodos, 2 Anisópodos), 2 sipuncúlidos y 10 equinodermos, lo que supone un total de 205 especies identificadas repartidas entre *Caulerpa prolifera*, *C. taxifolia*, *C. racemosa* var. *cylindracea* y *Posidonia oceanica*.

El mayor número de especies de poliquetos encontradas corresponde a la pradera de *C. taxifolia*, con 53 especies. Han sido identificadas 30 especies de moluscos en *C. taxifolia* y *C. racemosa* var. *cylindracea* (praderas con más especies). La diversidad de especies de crustáceos es mayor en *C. racemosa* var. *cylindracea* respecto a los otros hábitats estudiados, con 41 especies identificadas. El número de especies de sipuncúlidos y equinodermos son bajos, encontrándose como máximo 2 especies de sipuncúlidos en *C. taxifolia* y *C. racemosa* var. *cylindracea* y 8 especies de equinodermos en *C. racemosa* var. *cylindracea* y *Posidonia oceanica* (Fig. 8, tabla 2).

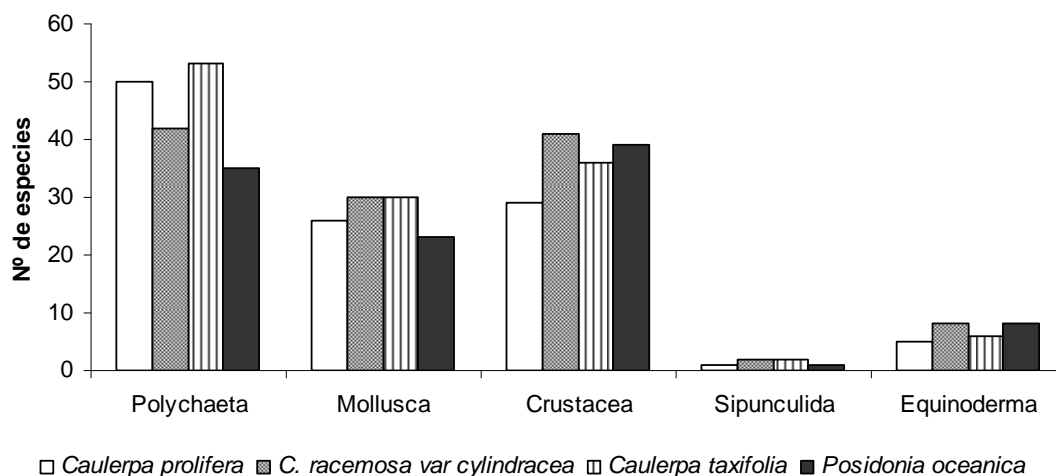

Fig 8: Número de especies, de los principales filums y órdenes, identificadas en los cuatro hábitats estudiados.

Tabla 2: Especies encontradas en los cuatro hábitats estudiados. * significa la presencia de las especies en la pradera que marca la columna

	<i>Caulerpa prolifera</i>	<i>Caulerpa taxifolia</i>	<i>C. racemosa var. cylindracea</i>	<i>Posidonia oceanica</i>
Polychaeta				
<i>Acanthicolepis asperrima</i> (M. Sars, 1861)	*	*		
<i>Amphiglena mediterranea</i> (Leydig, 1851)		*		
<i>Arabella iricolor</i> (Montagu, 1804)	*	*	*	*
<i>Aricidea similis</i> (Fauchald, 1972)		*	*	*
<i>Armandia cirrhosa</i> Filippi, 1861		*		
<i>Armandia polyophthalma</i> Kukenthal, 1887	*	*		
<i>Cirriformia tentaculata</i> (Montagu, 1808)	*	*		
<i>Chone infundibuliformis</i> Kroeyer, 1856	*			
<i>Chone sp</i> Kroeyer, 1856	*	*	*	*
<i>Chrysopetalum debile</i> (Grube, 1855)	*	*		
<i>Eteone longa</i> (Fabricius, 1780)		*		
<i>Eunice harassii</i> Audouinin & Milne Edwards, 1834		*		*
<i>Eunice vittata</i> (Delle Chiaje, 1828)	*	*	*	*
<i>Exogone (exogone) dispar</i> (Webster, 1879)			*	
<i>Exogone (exogone) rostrata</i> Naville, 1933	*	*	*	
<i>Exogone (exogone) verugera</i> (Claparède, 1868)	*			
<i>Fabricia sabella</i> (Ehrenberg, 1836)	*			
<i>Fimbriosthenelais minor</i> (Pruvot & Racovitza, 1895)		*	*	
<i>Glycera sp.</i> (Savigny, 1818)	*		*	
<i>Goniada sp.</i> (Audouin & Mildne Edwards, 1933)		*		
<i>Haplosyllis spongicola</i> (Grube, 1855)			*	*
<i>Harmothoe spinifera</i> (Ehlers, 1864)	*	*		
<i>Heteromastus filiformis</i> (Calparède, 1844)	*	*		
<i>Aponuphis bilineata</i> (Baird, 1870)	*	*	*	*
<i>Hydroides nigra</i> (Zibrowius, 1971)				*
<i>Laetmonice hystrix</i> (Savigny in Lamarck, 1818)		*		
<i>Lumbrineris coccinea</i> (Renier, 1804)		*		
<i>Lumbrineris gracilis</i> Ehlers, 1868	*	*	*	*
<i>Lumbrineris impatiens</i> (Claparède, 1868)	*	*		*
<i>Lumbrineris latreilli</i> Audouin & Milne Edwards, 1834	*	*		
<i>Lumbrineropsis paradoxa</i> (Saint-Joseph, 1888)	*	*	*	*
<i>Lysidice collaris</i> Grube, 1870		*		
<i>Lysidice ninetta</i> Audouin & Milne Edwards, 1833	*	*	*	*
<i>Malmgreniella lunulata</i> (Delle Chiaje, 1830)	*		*	
<i>Marphysa fallax</i> Marion & Bobrezky, 1875		*		
<i>Neanthes agulhana</i> (Day, 1963)	*	*	*	*
<i>Neanthes caudata</i> (Delle Chiaje, 1833)	*		*	*
<i>Nematonereis unicornis</i> Schmarda, 1861	*	*	*	*
<i>Nereis falsa</i> Quatrefages, 1866	*			
<i>Notomastus aberans</i> Day, 1957		*		*
<i>Notomastus latericeus</i> Sars, 1851	*		*	

	<i>Caulerpa prolifera</i>	<i>Caulerpa taxifolia</i>	<i>C. racemosa</i> var. <i>cylindracea</i>	<i>Posidonia oceanica</i>
<i>Notomastus (Clistomastus) lineatus</i> (Claparède, 1869)	*	*	*	*
<i>Oriopsis armandi</i> (Claparède, 1864)	*	*	*	*
<i>Palolo siciliensis</i> (Grube, 1840)				
<i>Paradoneis armata</i> Glemarec, 1966	*			*
<i>Paraonis lyra</i> Southern, 1914	*	*	*	
<i>Parapionosyllis brevicirra</i> Day, 1954			*	
<i>Pectinaria (Amphictene) auricoma</i> (O. F. Mulle, 1776)		*	*	
<i>Pectinaria (Lagis) koremi</i> (Malmgren, 1866)	*	*	*	*
<i>Pelogenia arenosa</i> (Delle Chiaje, 1830)	*	*	*	*
<i>Pherusa eruca</i> (Claparède, 1870)	*	*	*	*
<i>Pholoe inornata</i> Johnston, 1839	*	*	*	
<i>Phyllodoce (Anaitides) mucosa</i> Oersted, 1843		*	*	
<i>Pista cretacea</i> (Grube, 1960)	*	*		*
<i>Platynereis dumerilii</i> (Audouin & Milne Edwards, 1833)	*	*	*	*
<i>Polyophthalmus pictus</i> (Dujardin, 1839)	*	*	*	*
<i>Pontogenia chrysocoma</i> (Baird, 1865)	*	*	*	*
<i>Praxillella praetermissa</i> (Malmgren, 1865)	*			*
<i>Pterocirrus macroceros</i> (Grube, 1860)		*		*
<i>Schistomeringos neglecta</i> (Fauverl, 1923)	*			
<i>Schistomeringos rudolphi</i> (Delle Chiaje, 1828)	*		*	*
<i>Sphaerosyllis austriaca</i> Banse, 1959	*	*	*	
<i>Sphaerosyllis pirifera</i> Claparède, 1868	*	*	*	*
<i>Spirobranchus polytrema</i> (Philippi, 1844)			*	*
<i>Sthenelais boa</i> (Johnston, 1833)	*	*	*	*
<i>Syllis corallicola</i> Verrill, 1900	*	*		
<i>Syllis garciai</i> (Campoy, 1982)	*	*	*	*
<i>Syllis gerlachi</i> (Hartmann-Schröder, 1960)	*	*	*	*
<i>Syllis variegata</i> Grube, 1860	*	*	*	*
<i>Syllis westheidei</i> San Martín, 1981	*		*	
<i>Thelepus setosus</i> (Quatrefages, 1866)		*		
<i>Tharix marioni</i> (Saint Joseph, 1894)		*		
<i>Vermiliopsis striaticeps</i> (Grube, 1862)	*		*	
Mollusca				
<i>Alvania cancellata</i> (da Costa, 1778)			*	
<i>Alvania cimex</i> (Linné, 1758)	*	*	*	*
<i>Alvania montagui</i> (Payraudeau, 1826)		*		
<i>Arca noae</i> Linnaeus, 1758		*	*	*
<i>Arcopagia balaustina</i> (Linnaeus, 1758)	*	*		
<i>Ascobulla fragilis</i> (Jeffreys, 1856)	*	*	*	
<i>Barbatia barbata</i> (Linné, 1758)			*	
<i>Bittium latreillii</i> (Payraudeau, 1826)		*		
<i>Bittium reticulatum</i> (da Costa, 1778)	*	*	*	*

	<i>Caulerpa prolifera</i>	<i>Caulerpa taxifolia</i>	<i>C. racemosa var. cylindracea</i>	<i>Posidonia oceanica</i>
<i>Bulla striata</i> Bruguière, 1792	*			*
<i>Cerithium vulgatum</i> Bruguière, 1792	*	*	*	*
<i>Columbella rustica</i> (Linnaeus, 1758)	*			
<i>Coralliophila squamosa</i> (Bivona Ant. in Bivona And., 1838)		*		
<i>Crepidula unguiformis</i> Lamarck, 1822		*		
<i>Ctena decussata</i> (Costa O.G., 1829)	*	*	*	*
<i>Chama gryphoides</i> Linnaeus, 1758		*	*	*
<i>Dacrydium hyalinum</i> Monterosato, 1875		*		
<i>Gastrana fragilis</i> (Linnaeus, 1758)		*		
<i>Gibbula ardens</i> (Von Salis, 1793)	*		*	
<i>Glans trapezia</i> (Linnaeus, 1767)	*	*	*	*
<i>Irus irus</i> (Linnaeus, 1758)	*	*		
<i>Jujubinus exasperatus</i> (Pennant, 1777)	*			
<i>Limaria hians</i> (Gmelin, 1791)			*	*
<i>Loripes lacteus</i> (Linnaeus, 1758)	*	*	*	*
<i>Lobiger serradifalci</i> (Calcar 1840)	*	*		
<i>Lucinella divaricata</i> (Linnaeus, 1758)	*	*	*	
<i>Metaxia abrupta</i> (Watson, 1880)			*	
<i>Modiolarca subpicta</i> (Cantraine, 1835)			*	
<i>Modiolus barbatus</i> (Linnaeus, 1758)	*	*	*	*
<i>Musculus costulatus</i> (Risso, 1826)			*	
<i>Mysella bidentata</i> (Montagu, 1803)		*		
<i>Nassarius incrassatus</i> (Ström, 1768)	*		*	
<i>Oxynoe olivacea</i> Rafinesque, 1814	*	*		
<i>Paphia rhomboides</i> (Pennant, 1777)	*			
<i>Parvicardium exiguum</i> (Gmelin, 1791)	*	*	*	*
<i>Parvicardium scriptum</i> (Bucquoy, Dautzenberg & Dollfus 1892)			*	
<i>Payraudeautia intricata</i> (Donovan, 1804)	*		*	*
<i>Petalifera petalifera</i> (Rang 1928)			*	
<i>Pinna nobilis</i> Linnaeus, 1758				*
<i>Pusillina philippi</i> (Aradas & Maggiore, 1844)		*		
<i>Rissoina bruguieri</i> (Payraudeau, 1826)		*	*	*
<i>Ruditapes decussatus</i> (Linnaeus, 1758)	*			
<i>Smaragdia viridis</i> (Linnaeus, 1758)			*	*
<i>Striarca lactea</i> (Linnaeus, 1758)	*		*	*
<i>Tellina (Moerella) donacina</i> Linnaeus, 1758		*		*
<i>Tricolia pullus</i> (Linnaeus, 1758)	*	*	*	*
<i>Tricolia speciosa</i> (Von Mühlfeldt, 1824)	*			*
<i>Venericardia antiquata</i> (Linné, 1758)		*	*	
<i>Venerupis aurea</i> (Gmelin, 1791)	*	*	*	*
<i>Venus casina</i> Linnaeus, 1758		*		
<i>Venus verrucosa</i> Linnaeus, 1758		*	*	*

	<i>Caulerpa prolifera</i>	<i>Caulerpa taxifolia</i>	<i>C. racemosa</i> var. <i>cylindracea</i>	<i>Posidonia oceanica</i>
Crustacea				
Decapoda				
<i>Achaeus cranchii</i> Leach, 1817	*	*	*	*
<i>Alpheus dentipes</i> Guérin-Méneville, 1832	*	*	*	*
<i>Alpheus macrocheles</i> (Hailstone, 1835)		*		*
<i>Athanas nitescens</i> (Leach, 1814)	*	*	*	*
<i>Automate branchialis</i> Holthuis & Gottlieb, 1958	*	*	*	*
<i>Calcinus tubularis</i> (Linnaeus, 1767)	*	*	*	*
<i>Cestopagurus timidus</i> (Roux, 1830)	*	*	*	*
<i>Dromia personata</i> (Linnaeus, 1758)				*
<i>Ebalia edwardsii</i> Costa, 1838		*		*
<i>Galathea bolivari</i> Zariquiey-Alvarez, 1950	*	*	*	*
<i>Galathea cenanroi</i> Zariquiey-Alvarez, 1968				*
<i>Galathea squamifera</i> Leach, 1814	*		*	
<i>Hippolyte inermis</i> Leach, 1815	*	*	*	*
<i>Hippolyte niezabitoskii</i> D'Udekem d'Acoz, 1996		*		*
<i>Hippolyte garciarasoii</i> D'Udekem d'Acoz, 1996	*	*	*	*
<i>Eualus cranchii</i> (Leach, 1817)		*	*	*
<i>Palaemon xiphias</i> Risso, 1816		*		
<i>Illia nucleus</i> (Linnaeus, 1758)	*	*	*	*
<i>Liocarcinus navigator</i> (Herbst, 1794)	*		*	
<i>Liocarcinus corrugatus</i> (Pennant, 1777)	*		*	
<i>Macropodia linaresi</i> Forest & Zariquiey-Alvarez, 1964			*	
<i>Macropodia longirostris</i> (Fabricius, 1775)		*		*
<i>Pagurus anachoretus</i> Risso, 1827		*	*	*
<i>Pilumnus hirtellus</i> (Linnaeus, 1761)	*		*	*
<i>Pisa muscosa</i> (Linnaeus, 1758)		*	*	*
<i>Pisa tetraodon</i> (Pennant, 1777)		*		*
<i>Pisidia longimana</i> (Risso, 1816)				*
<i>Processa edulis</i> (Risso, 1816)	*	*	*	*
<i>Sirpus zariquieyi</i> Gordon, 1953	*	*	*	*
<i>Upogebia mediterranea</i> Noël, 1992	*		*	
<i>Upogebia pusilla</i> (Petagna, 1792)	*	*	*	*
<i>Xantho granulicarpus</i> Forest, 1953				*
<i>Xantho pilipes</i> A. Milne-Edwards, 1867	*	*	*	*
Amphipoda				
<i>Pariambus typicus</i> (Kroyer, 1844)	*			
<i>Caprella acanthifera</i> Leach, 1814	*	*	*	*
<i>Phtisica marina</i> Slabber, 1769	*	*	*	*
<i>Pseudoprotella phasma</i> (Montagu, 1804)				*
<i>Caprella cavediniae</i> Krapp-Schickel & Vader, 1998		*		
<i>Deutella shieckei</i> Cavedini, 1982		*		

	<i>Caulerpa prolifera</i>	<i>Caulerpa taxifolia</i>	<i>C. racemosa var. cylindracea</i>	<i>Posidonia oceanica</i>
<i>Harpinia truncata</i> Sars, 1891		*		
<i>Leptocheirus guttatus</i> (Grube, 1864)			*	
<i>Maera grossimana</i> (Montagu, 1808)			*	
<i>Erichthonius argenteus</i> Krapp-Schickel, 1993	*	*		*
<i>Maera hirondellei</i> Chevreux, 1900			*	
<i>Harpinia zavodniki</i> Karaman, 1987	*			*
<i>Maera inaequipes</i> (Costa, 1857)		*	*	
<i>Melita valesi</i> Karaman, 1955	*			
<i>Colomastix pusilla</i> Grube, 1861			*	
<i>Ampelisca</i> sp Krøyer, 1842				*
<i>Gammarella fucicola</i> (Leach, 1814)	*			
<i>Iphimedia minuta</i> G.O. Sars, 1882				*
<i>Monoculodes</i> Stimpson, 1853			*	
<i>Dexamine spinosa</i> (Montagu, 1813)		*	*	*
<i>Biancolina algicola</i> Della Valle, 1893			*	
<i>Amphilochus neapolitanus</i> Della Valle, 1893			*	
<i>Harpinia crenulata</i> (Boeck, 1871)		*		
<i>Perioculodes longimanus</i> (Bate & Westwood, 1868)			*	
<i>Leucothoe spinicarpa</i> (Abildgaard, 1789)			*	
<i>Liljeborgia dellavallei</i> Stebbing, 1906				*
<i>Maera pachytelson</i> Karaman & Ruffo, 1971	*	*		
<i>Leptocheirus bispinosus</i> Norman, 1908			*	*
<i>Atylus guttatus</i> (Costa, 1851)			*	
<i>Nuanuu beatricensis</i> (Jaume & Box, 2006)		*	*	
Anisopoda				
<i>Leptocheila dubia</i> agg. sp. nov.	*	*	*	*
<i>Apseudes latreillii</i> (Milne-Edwards, 1828)	*	*	*	*
Sipunculida				
<i>Sipunculus nudus</i> Linnaeus, 1766		*		*
<i>Aspidosiphon muelleri</i> Diesing, 1851	*	*	*	
<i>Phascolosoma granulatum</i> Leuckart, 1828			*	
Equinoderma				
<i>Echinocyamus pusillus</i> (O.F. Müller, 1776)	*	*		*
<i>Genocidaris maculata</i> A. Agassiz, 1869		*	*	*
<i>Holothuria</i> spp Linnaeus, 1767	*	*	*	*
<i>Ophioderma longicaudum</i> (Retzius, 1789)	*	*	*	*
<i>Amphipholis squamata</i> (Delle Chiaje, 1828)	*	*	*	*
<i>Ophiothrix fragilis</i> (Abildgaard, 1789)			*	*
<i>Amphiura chiajei</i> Forbes, 1843	*	*	*	
<i>Ophiura pentagona</i> Lamarck, 1816				*
<i>Asterina pancerii</i> (Gasco, 1870)			*	*
<i>Paracentrotus lividus</i> (de Lamarck, 1816)			*	

Discusión

Las caulerpales generan un hábitat diferenciado de la pradera de *Posidonia oceanica* al colonizar las áreas donde la parte folial de la pradera ha desaparecido. La magnitud de este cambio se refleja en mayores abundancias de invertebrados y mayor número de especies de moluscos y poliquetos en las caulerpales estudiadas.

Nuestros resultados muestran una zona invadida por *Caulerpa taxifolia*, con unas abundancias superiores a *Posidonia oceanica* de crustáceos, moluscos y poliquetos. Los trabajos previos, muestran que la invasión de *C. taxifolia*, en zonas de sustrato rocoso, conlleva una reducción de las abundancias de invertebrados especialmente para anfípodos y moluscos (BellanSantini et al. 1996). Esta reducción de anfípodos ya ha sido también observada en California, Hedionda Lagoon, en un estudio sobre sustrato blando (Tippets 2002).

Caulerpa taxifolia no siempre tiene un efecto deletéreo sobre la fauna y puede generar un hábitat adecuado para algunos invertebrados. En un estudio sobre meiofauna realizado en Croacia, el principal resultado obtenido es que *C. taxifolia* al colonizar áreas de fanerógamas marinas puede proporcionar un hábitat adecuado para los invertebrados bentónicos (Travizi and Zavodnik 2004).

Otro trabajo referido al bivalvo *Anadara trapezia*, realizado en Australia, concluye que la invasión proporciona un hábitat que no afecta negativamente al reclutamiento y a adultos de esta especie (Gribben and Wright 2006). En las Islas Baleares el patrón de invasión no implica la formación de praderas monoespecíficas, pero sí que significa la coexistencia de *C. taxifolia* con las comunidades de macroalgas y fanerógamas marinas locales. La no formación de praderas monoespecíficas genera un incremento en la heterogeneidad de hábitat que permite compartir hábitat a especies que en otras condiciones no lo harían.

Puede que lo anterior se explique porque no se observen efectos negativos sobre las comunidades de invertebrados y sí que se observe la presencia de especies de *Posidonia oceanica* cohabitando en *C. taxifolia* con otras especies oportunistas o específicas de *Caulerpa*.

La comunidad de invertebrados de *Caulerpa racemosa* var. *cylindracea* nos muestra un incremento para la abundancia de crustáceos, moluscos, decápodos y equinodermos respecto a *Posidonia oceanica*. Al igual que *C. taxifolia*, en *C. racemosa*

var. *cylindracea* son escasos los trabajos referentes a los efectos del macroalga sobre la comunidad de invertebrados. Argyrou et al (1999) encontró que gasterópodos y crustáceos experimentaron una reducción en sus abundancias, mientras que bivalvos, equinodermos y especialmente poliquetos aumentaron tras el reemplazo de *P. oceanica* por *Caulerpa racemosa*. Un estudio más reciente, destaca el efecto positivo de *C. racemosa* sobre los moluscos, donde sus formas juveniles encuentran un hábitat adecuado para su asentamiento (Buia et al. 2001).

Como se ha demostrado en capítulos anteriores y en el presente capítulo, la fauna encontrada en *Caulerpa racemosa* var. *cylindracea* está influenciada por las otras comunidades que rodean a *C. racemosa* como *P. oceanica*, comunidades de algas fotófilas y fondos arenosos. Esta confluencia de especies es la responsable del incremento en abundancias que experimentan los anisópodos y decápodos.

La comunidad de *Caulerpa prolifera* presenta mayor abundancia de moluscos y poliquetos que las *Caulerpa* invasoras y *Posidonia oceanica*. En la literatura podemos encontrar gran cantidad de trabajos sobre la comunidades de invertebrados en *C. prolifera* (Sanchez-Moyano et al. 2001a; Sanchez-Moyano et al. 2001b; Guerra-Garcia et al. 2002; Rueda and Salas 2003; Sanchez-Moyano et al. 2004; de la Rosa et al. 2006), destacándose entre ellos algunos desarrollados en las Islas Baleares (Ballesteros et al. 1987; Dantart et al. 1990). Las praderas de *C. prolifera* se caracterizan por las elevadas abundancias y diversidad de especies de moluscos y poliquetos Este resultado es similar al obtenido por Sanchez-Moyano et al. (2001b) en *C. prolifera*.

Caulerpa prolifera, en la localidad estudiada, crece sobre rizomas de *Posidonia* al igual que las *Caulerpa* invasoras. Pero el tiempo de colonización del sustrato de esta clorofícea es más largo y por tanto cambia ampliamente los parámetros físico-químicos del sustrato (Jorge Terrado com. pers) por lo que la disimilitud en el hábitat es mayor con *Posidonia oceanica* que en el caso de las caulerpales invasoras. Este hábitat más diferenciado y su larga permanencia en el Mediterráneo es responsable que *C. prolifera* presente una comunidad de invertebrados en algunos casos altamente especializada.

Caulerpa taxifolia y *C. racemosa* son especies recién llegadas a Baleares y carecen especies especializadas en Baleares. Son las especies de invertebrados locales las que se han de adaptar a las zonas invadidas. En ambas *Caulerpa* invasoras confluyen especies de los hábitats próximos, la riqueza de organismos detritívoros de la mata muerta de *Posidonia oceanica* (Borg et al. 2006) y la riqueza típica de los bordes de praderas de fanerógamas marinas (Sanchez-Jerez et al. 1999b).

En un principio era de esperar un efecto negativo sobre la abundancia de fauna bentónica, pero como los resultados muestran, el efecto de la presencia de macroalgas invasoras del género *Caulerpa* no puede ser considerado como negativo. En los casos más drásticos de invasión sí que se han encontrado efectos importantes sobre la fauna (BellanSantini et al. 1996). Es por tanto necesario continuar con un seguimiento de la expansión y evolución de las comunidades faunísticas en áreas invadidas por macroalgas. En la literatura actual hay multitud de ejemplos de efectos de especies invasoras sobre las comunidades bentónicas (Bax et al. 2003; Levi and Francour 2004; Padilla and Williams 2004; Verlaque et al. 2004; Longepierre et al. 2005; Gribben and Wright 2006; Streftaris and Zenetos 2006; Antoniadou and Chintiroglou 2007; Galil 2007) por citar algunos trabajos. Los resultados obtenidos y su comparación con la literatura disponible muestran que cada especie tiene unos patrones de alteración del medio y la comunidades de invertebrados diferentes.

5.3 A new species of *Nuuanu* (Amphipoda: Gammaridea: Melitidae) from shallow sandy bottoms of the Balearic Islands (W Mediterranean)

Introduction

Nuuanu is a genus of melitid amphipods comprising 10 mostly shallow-water species known from tropical and warm-temperate seas, with species distributions usually restricted to a single locality. Records of this genus appear scattered through the Hawaiian Islands, Micronesia, E Australia, Andaman Islands, Madagascar, SE Africa, W Mediterranean, and the Caribbean, either in anchialine caves, marine macroporous interstitial environments, or exceptionally in the deep-sea. The genus is considered to be of tropical affinity and Tethyan origin, although *N. castellana* (Griffiths, 1977) was reported from deep muddy bottoms (at 550 m depth) off the east coast of South Africa (Martí and Villora-Moreno, 1995). Here we describe a new species associated with coarse sandy sediments in shallow waters of the Balearic Islands. In the Mediterranean, there was a previous report of the genus, *Nuuanu garciai* (Martí and Villora-Moreno, 1995), from coarse sandy bottoms at Chafarinas Islands (northern Moroccan coast). The only other gammarellid (sensu Lowry and Watson, 2002) known from the area is *Gammarella fucicola* (Leach, 1814), widely distributed along the Mediterranean and NE Atlantic coasts, and present also at the Balearic stations that rendered the new species described herein.

The new taxon was gathered in the framework of a research project aiming to evaluate the effects of the colonization of the rhizomes of the seagrass *Posidonia oceanica* Delile by the macroalgae *Caulerpa prolifera* (Forsskal) J. V. Lamouroux (native), and the alien tropical *Caulerpa racemosa* (Forsskal) J. Agardh and *C. taxifolia* (M. Vahl) C. Agardh. It is possible that the new amphipod could be an alien species introduced from a distant tropical location with the alien algae, but we prefer to regard it as an ancient Mediterranean element because its peracarid condition, regressed visual apparatus, and crevicular-interstitial existence all suggest a significantly reduced potential for dispersal.

Material and methods

Nuuanu beatricis sp. nov. was collected at Portals Vells cove (Calvià, Mallorca, Balearic Islands) at 3 m depth among *Posidonia oceanica* rhizomes colonized by *Caulerpa racemosa*. It was also gathered at Cala d'Or cove (Santanyí; Mallorca) between 4-8 m depth among *Posidonia oceanica* rhizomes colonized by *Caulerpa taxifolia* and *Caulerpa prolifera*. Collection of specimens proceeded using a 20x20 cm frame set by scuba-diving in the rhizome bed until 5 centimetres depth; both sediment and rhizomes inside the frame were removed and placed in a net-bag of 200 µm mesh size, which was transferred to a plastic flask with seawater for transport to the laboratory, prior to fixation with formalin. Sediment at Portals Vells consisted of biogenic medium sand (mean grain size: 250 µm), whereas at Cala d'Or mean grain size of the sand was smaller (125-250 µm). Once in the laboratory, amphipods were sorted under the stereomicroscope and their internal tissues partially digested with lactic acid to facilitate observation. Drawings were prepared using a camera lucida on an Olympus BH-2 microscope equipped with Nomarski differential interference contrast. Body measurements were derived from the sum of the maximum dorsal distances of somites and exclude telson length. Appendages preserved in permanent slides were mounted in lactophenol and the coverslips sealed with nail varnish. Materials are deposited in the Crustacea collection of The Natural History Museum, London [BMNH].

Taxonomy

Suborder GAMMARIDEA

Family MELITIDAE Bousfield, 1977

Genus *Nuuanu* J. L. Barnard, 1970 emend. Lowry and Watson, 2002

Nuuanu beatricis sp. nov.

(Figs. 1-10)

Material examined: Portals Vells, Calvià, Mallorca (Balearic Islands); UTM coordinates (Datum Europe 50): 4369557 / 31 459026. HOLOTYPE: brooding female (oostegites developed, setose) 3.59 mm [BMNH reg. no. 2006.359]; PARATYPES: male 2.48 mm with left second gnathopod dissected and mounted on single slide; 2

females without oostegites, 3.25 mm (completely dissected and mounted on single slide) and 2.81 mm; other 2 female specimens partially damaged, not measured [BMNH reg. nos. 2006.360-364].

Diagnosis

Antennule non-geniculate, much longer than antenna. Distal segment of mandibular palp shorter than second, armed with both D and E setae. Second segment of mandibular palp with 2 setae. Posteroventral lobe (sensu Lowry and Watson, 2002) on posterior margin of coxa 4 wanting. Reduced spine present on medial surface of coxa 5. Posterior margin of basis of pereopod 5 convex. Anterodistal lobe of coxa 7 wanting. Posterior margin of basis of pereopod 7 sparsely serrated along proximal half only. Pleonites 1-2 lacking dorsodistal spines. Anterodistal corner of epimeral plate 1 rounded. Exopod of uropod 3 longer than protopod. Telson with terminal spine on each lobe.

Description of female

Body (Fig. 1) compact, with integument of somites and most limbs densely caespitose (e. g. Figs. 2E; 5; 7; 8A, D, F; 9A; 10A, F; integumental ornamentation omitted from rest of figures); tiny surface spinules with truncate tip observable at high magnification (not figured). Head (Fig. 2A) with obtuse triangular lateral cephalic lobes and with deep anteroventral notch. Eyes hardly developed, with separated ommatidia (Fig. 1). Pleonites lacking dorsodistal spines (Fig. 1A). Epimeral plates 1-3 (Fig. 9A) with evenly-rounded anteroventral corner and pointed posteroventral corner; ventral margin of epimeral plate 1 straight, margins of plates 2-3 convex; posterior margin of plate 1 strongly convex, those of plates 2-3 slightly convex; short and stout seta present submarginally close to anteroventral corner of plate 2; posterodistal corner of plate 3 variably produced, from falcate in smaller specimens (including male; Fig. 9B) to less produced in bigger specimens (Fig. 9A). Urosomite 1 without dorsal keel; urosomites 2-3 with posterodorsal spine at each side (Fig. 10A).

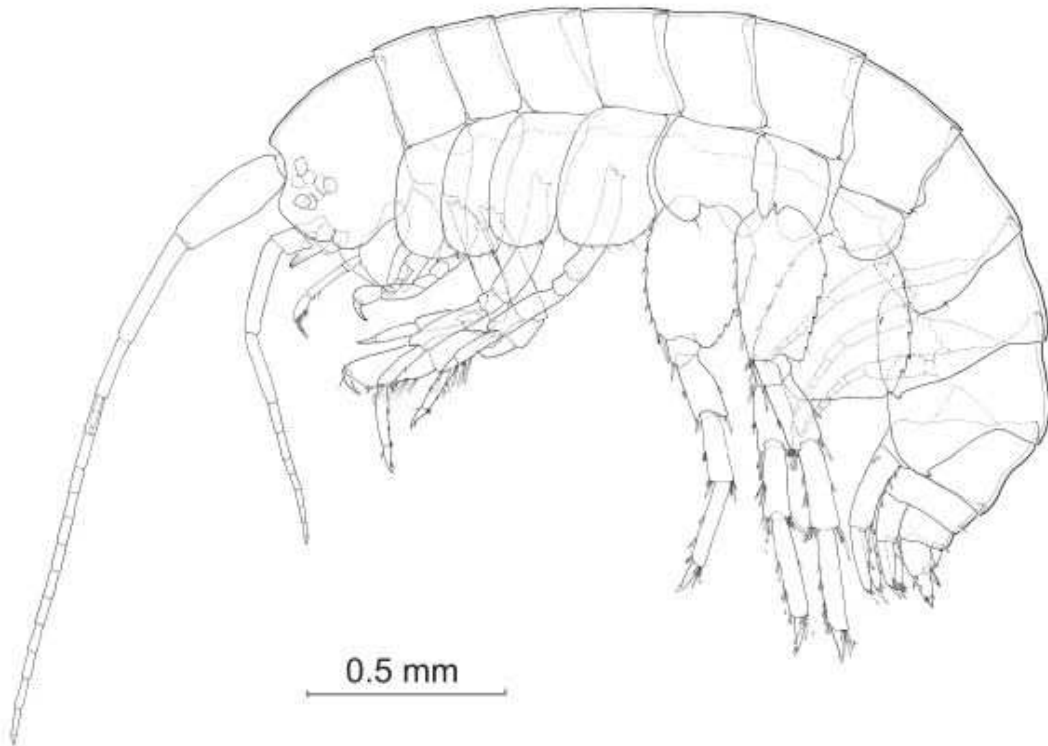

FIG. 1. – *Nuuanu beatricis* n. sp., habitus of brooding female holotype (coxal gills and oostegites omitted).

Antennule (Fig. 2A) non-geniculate, longer than antenna, with 3-segmented peduncle, 10 to 13-articulate main flagellum and 3-articulate accessory flagellum. First peduncle segment longer than segment 2, with 2 stout spines on posterior margin. Single aesthetasc on third peduncle segment and on 2nd to 8th articles of main flagellum.

Antenna (Fig. 2A) with 5-segmented peduncle and 8-articulate flagellum; second peduncle segment not produced dorsodistally, with short spine (Fig. 2E); gland cone acute. Flagellum about as long as 4 proximal peduncle segments taken together.

Labrum (Fig. 2B) globose with short epistome; 2 slits present on anterior surface. Paragnaths (Fig. 2C) with 2 sub-parallel rows of flattened hyaline spines with serrate tips on outer lobes; spines comprising posterior row smaller (Fig. 2D). Inner lobes wanting.

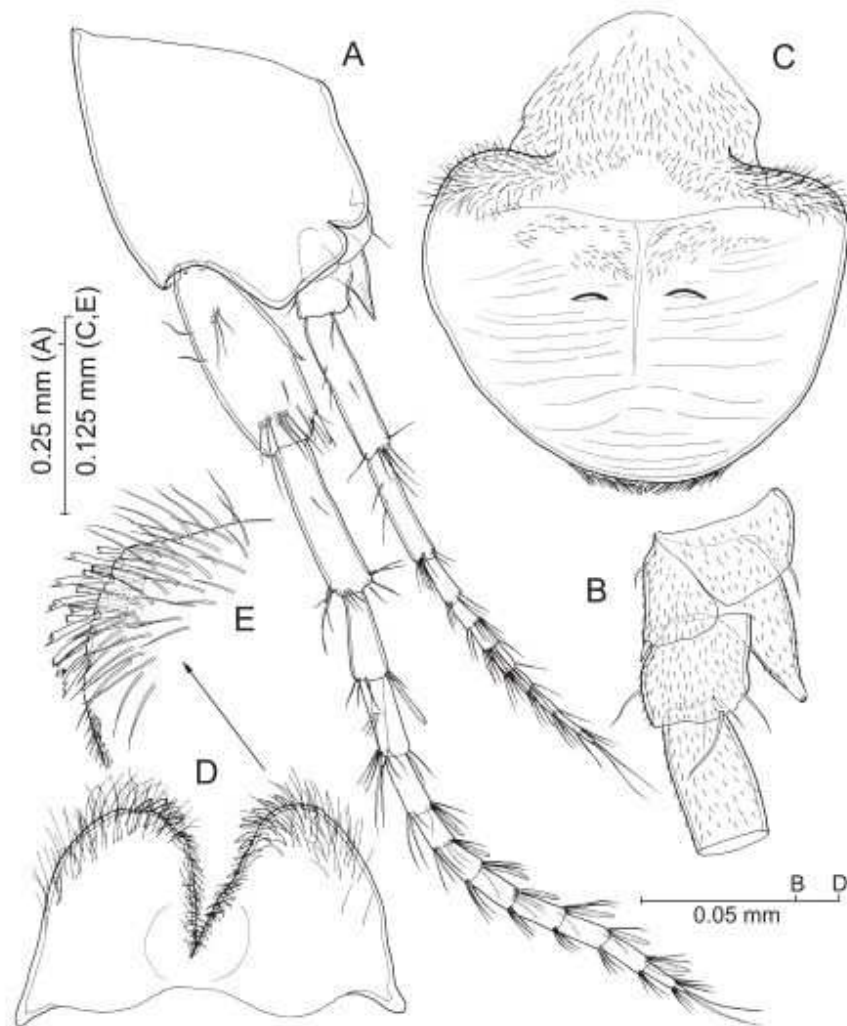

FIG. 2. – *Nymania beatrix* n. sp., female holotype. A, head with left antennule and antenna attached, lateral; B, detail of proximal portion of left antennal peduncle, lateral; C, labrum, anterior; D, paragnaths, anterior; E, detail of distomedial portion of right paragnath, anterior.

Left Mandible (Fig. 3A) with 6-cuspidate incisor and 4-cuspidate lacinia mobilis, latter similar in appearance and orientation to incisor process; basis of lacinia developed as articular condyle associated to incisor, which acts as articular socket. Spine row comprising 8 denticulate elements; row of 6 pappose slender setae running parallel to spine row on lateral side; molar process truncate, columnar, with patch of short, pappose slender setae basally on anterior margin, and long denticulate molar seta on posterior margin; grinding surface comprising series of parallel, sclerotized serrate ridges. Palp 3-segmented, second segment longest, with 2 unipinnate setae on distal half of anterior margin; distal segment about 75% length of preceding segment, with 9 stout, bipinnate D-setae with rounded tip and 3 E-setae, one of which smooth and reduced. Right Mandible (Fig. 3B) with 5-cuspidate incisor and articulated lacinia, latter bifurcate, distal branch 8-cuspidate, proximal branch 7-cuspidate; spine row comprising 6 spinulose elements, distalmost with row of rounded denticles similar to those of

lacinia on one margin; 2 short pappose slender setae disposed on lateral margin of spine row as figured.

Maxillule (Fig. 3C) coxal endite subtriangular with row of 9 stout bipinnate setae along medial margin and 3 shorter spines with multicuspid tip submarginally; 3 short spines subdistally close to unarmed tip of endite. Basal endite with 6+5 distal arrangement of stout denticulate spines. Endopod (= palp) bisegmented, distal segment with 5 short and stout distal spines, plus 2 setae with expanded rounded tip subdistally as in Fig. 3D. Outer margin of coxa and basis each with short seta close to distal corner.

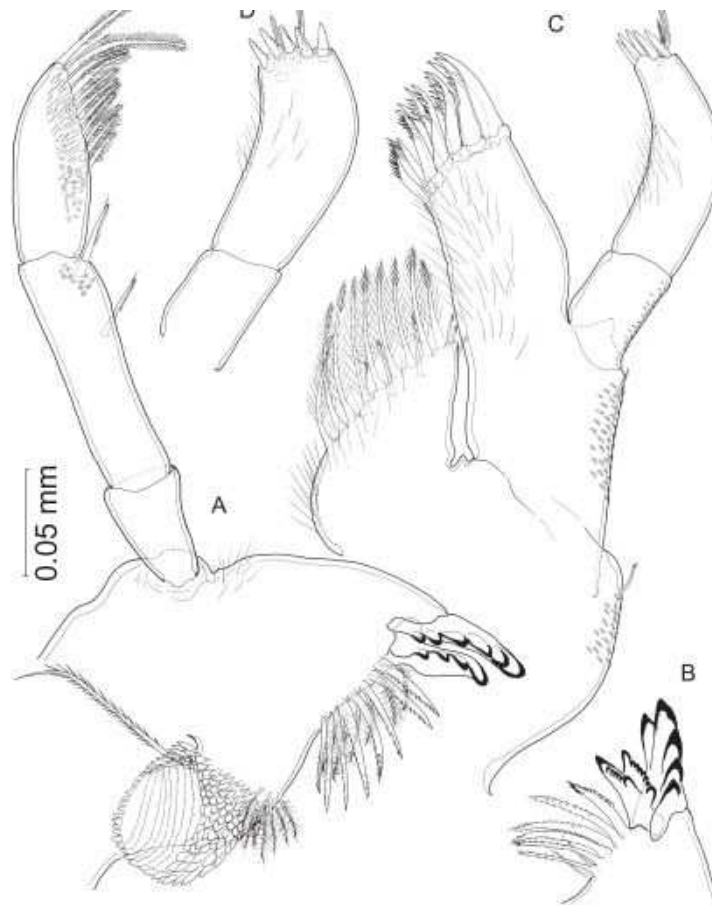

FIG. 3. - *Niuania beatrix* n. sp., female holotype. A, left mandible, medial; B, detail of incisor, lacinia mobilis and spine row of right mandible, medial; C, left maxillule, medial; D, detail of endopod of latter, anterior.

Maxilla (Fig. 4A) coxal endite (= inner lobe) with oblique row of 10 stout setae on anterior surface and 6 short spines along medial margin. Basal endite (= outer lobe) with 1 stout curved spine distally and transverse row of 5 additional stout curved spines subdistally on posterior surface of segment. Rest of armature on both endites as figured.

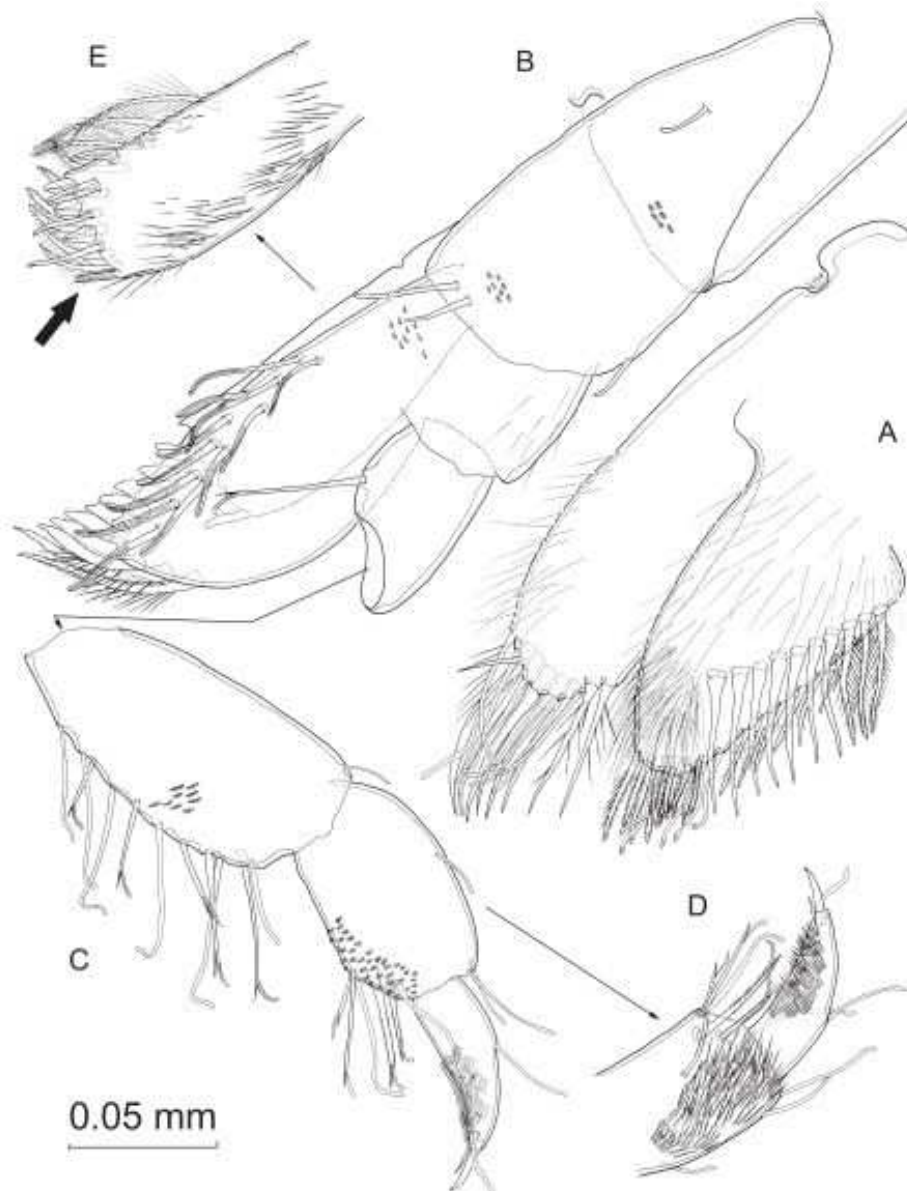

FIG. 4. - *Numana beatrix* n. sp., female holotype. A, right maxilla, anterior (ornamentation of several setae of oblique row on coxal endite omitted); B, right maxilliped with endopod partially disarticulated, posterior; C, carpus to dactylus of latter, posterior; D, detail of ornamentation of propodus and dactylus, anterior; E, detail of maxillipedal basal endite (arrow points to outlet of gland).

Maxillipeds (Fig. 4B) with fused coxae unarmed. Basis with 1 short seta close to distolateral corner and 3 setae on posterior surface of segment. Basal endite (= inner plate; Fig. 4E) subrectangular, with 2 smooth spines and 3 smooth setae on posterior surface; curved row of 9 spinulose setae on anterior surface, setae progressively shorter and stouter towards distolateral corner of endite, latter occupied by tubular outlet of unidentified gland (arrowed in Fig. 4E); distal margin of endite with 3 smooth stout spines on medial half. Ischium unarmed; ischial endite (= outer plate) reaching halfway along carpus (= second palp segment), with 7 denticulate stout spines along distomedial margin; 3 longer and more slender spines, spinulose proximally and denticulate distally,

on distolateral margin; cluster of about 12 smooth setae with rounded tip and presumably with pore terminally disposed submarginally close to medial margin on posterior surface of endite. Merus, carpus, propodus and dactylus (together comprising so-called palp) with relative proportions of segments as in Fig. 4B-C; patch of densely-set spinules on anterior surface of both carpus and propodus as in Fig. 4D.

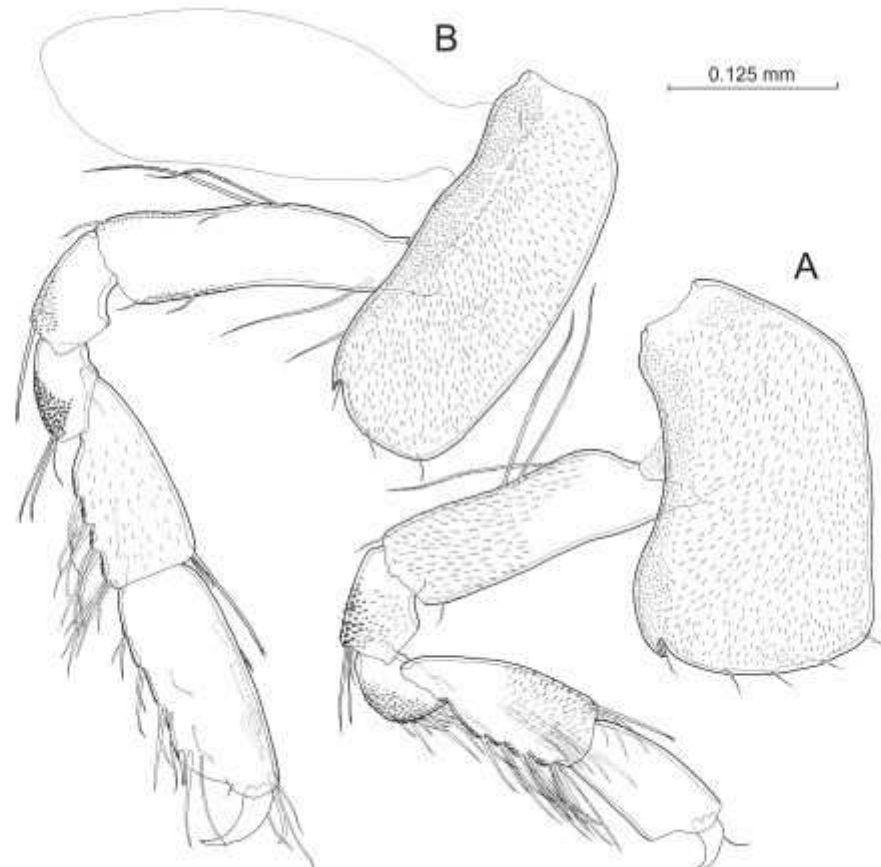

FIG. 5. – *Mikania bearricks* n. sp., female holotype. A, right first gnathopod, lateral; B, right second gnathopod, lateral. Armature of distal segments of both limbs partially outlined only (see Fig. 6 for details of ornamentation and armature of these segments).

Coxal gills on gnathopod 2 (Fig. 5B) and pereopods 3 to 6 (Figs. 7A, D; 8A, B, D), smooth, ovoid, hardly stalked. Oostegites (Fig. 7C) on second gnathopod and pereopods 3 to 5, narrow, with about 4 long setae and single short seta distally.

Gnathopods reduced compared to rest of pereopods (Fig. 1). Coxal plate of gnathopod 1 (Fig. 5 A) about twice longer than wide, roughly romboid due to strongly convex anterior margin; posterior margin deeply concave; posterodistal corner notched. Carpus longer than propodus, latter subchelate, with palm angle at about 75% maximum (= anterior margin) length of segment, bearing 2 flagellate bifid spines on medial side (Fig. 6B) and 4 flagellate bifid spines on lateral side (Fig. 6C); rest of armature on segments as in Figs. 5A and 6A. Gnathopod 2 (Fig. 5B) larger than gnathopod 1, with narrow subrectangular coxal plate, about 2.4 times longer than wide,

posterodistal corner notched; merus subquadrate posterodistally (Fig. 6D); carpus and propodus equal in length, propodal palm angle placed at about 71% maximum length of segment, with short flagellate bifid spine on medial margin and strong flagellate unicuspid spine on lateral margin; integument of palm margin microtuberculate (Fig. 6E). Rest of armature on segments as in Figs. 5B and 6D.

Pereopods 3-4 slender, pereopod 3 longer than 4 due to longer basis and merus. Pereopod 3 (Fig. 7A) coxa 2.1 times longer than wide, with convex anterior margin and shallowly excavate posterior margin, posterodistal corner notched; merus longer than carpus, and this shorter than propodus; claw (= dactylus + unguis) slender, dactylus with 2 smooth setae distally and one penicillate seta proximally on anterior margin (Fig. 7B). Pereopod 4 (Fig. 7D, E) similar to preceding limb except for coxa and for presence of more long marginal setae on basis; coxa expanded distally and with deeply concave posterior margin lacking so-called posteroventral lobe (Lowry and Watson, 2002).

Pereopods 5-7 with claws progressively shorter and more robust from 5th to 7th (compare Fig. 8C, E and F), each with 3 distal smooth setae and proximal penicillate seta on dactylus. Pereopod 5 (Fig. 8A) coxa about as long as wide, with evenly rounded anterior margin and slightly convex, almost straight posterior margin; equilobate: anterodistal lobe evenly rounded, not outreaching posterodistal lobe of segment; tiny spine (arrowed in Fig. 8B) present in homologous position to structure interpreted as putative sternal gill in other congeneric taxa (e.g. Vonk, 1988). Basis about 1.3 times longer than broad, posterior margin sparsely serrated, with triangular posterodistal lobe.

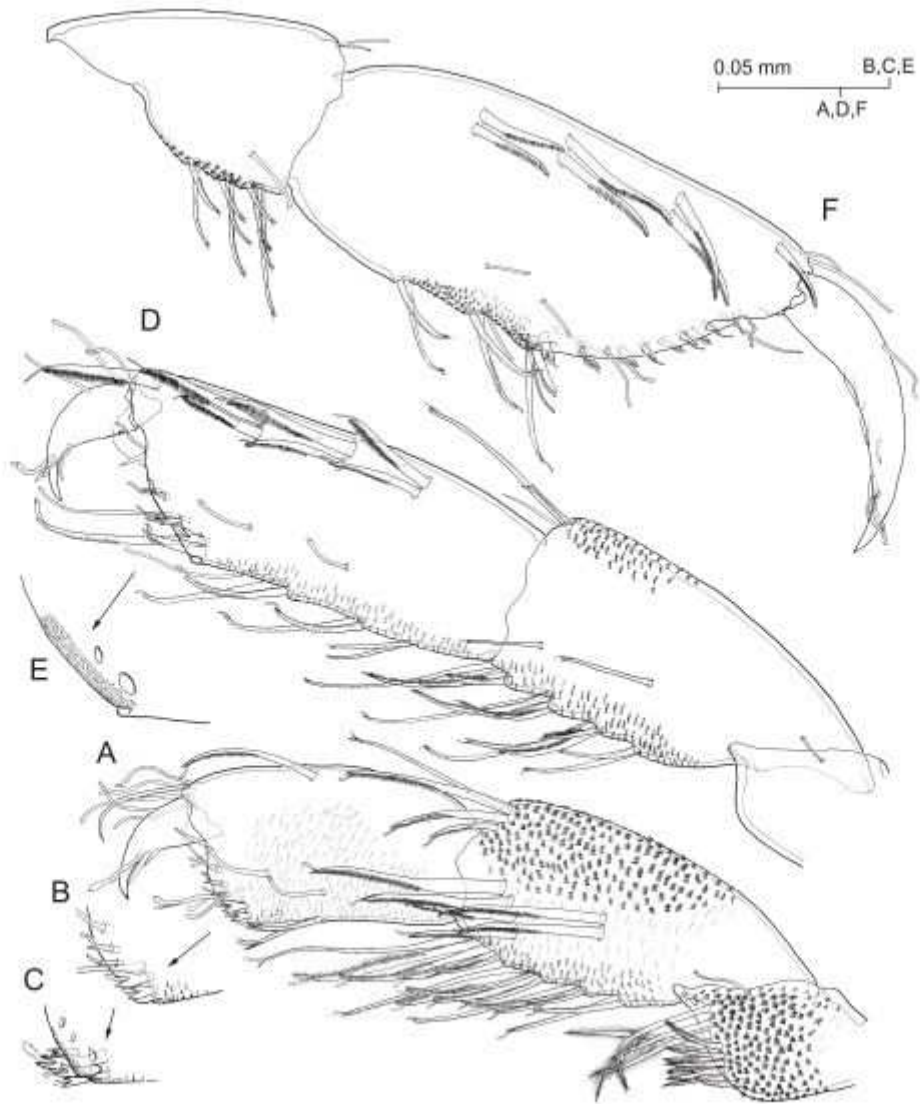

FIG. 6. - *Nuanu beatrix* n. sp. A, detail of distal portion of first gnathopod of female holotype, medial (lateral armature of palm angle omitted); B, detail of medial armature of palm angle; C, detail of lateral armature of palm angle; D, detail of distal portion of second gnathopod of female holotype, medial; E, detail of palm margin integumentary ornamentation, medial; F, detail of distal portion of second gnathopod of male paratype, medial.

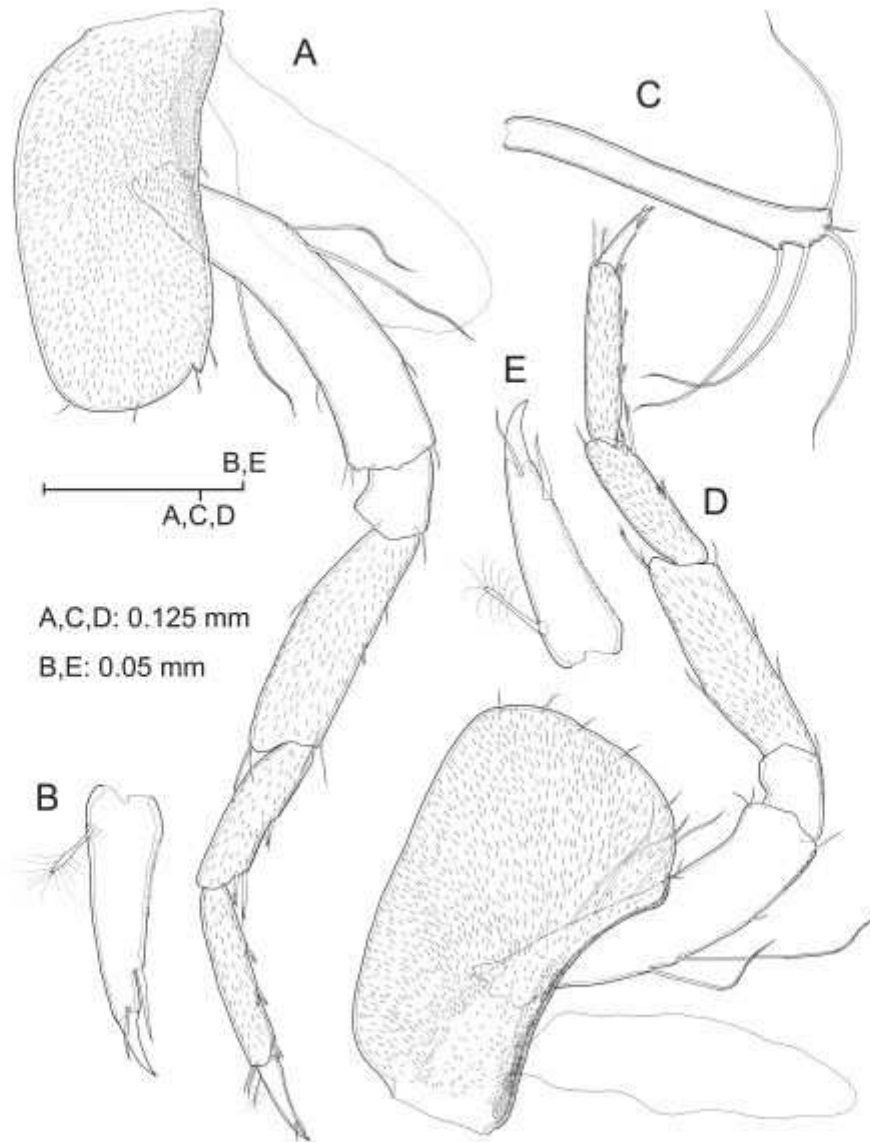

FIG. 7. - *Numaia beatrix* n. sp. A, left pereopod 3 of female holotype, lateral; B, detail of nail (dactylus + unguis); C, coxite on pereopod 3 of brooding female paratype; D, right pereopod 4 of female holotype, lateral; E, detail of nail.

Pereopod 6 (Fig. 8D) longest, with anterior margin of coxa straight, posterior margin slightly concave; coxa bilobate, anterodistal lobe triangular, separated from anterodistal corner of segment by wide notch, slender, not outreaching evenly rounded posterodistal lobe. Basis slender, about 1.7 times longer than broad, with sparsely serrated posterior margin and well-developed, evenly rounded posterodistal lobe.

Pereopod 7 (Fig. 8F) with coxa unilobed, anterodistal lobe wanting. Basis widely expanded posteriorly, plate-like, sparsely serrated only along proximal half of posterior margin, about 1.2 times longer than wide; posterodistal lobe evenly rounded.

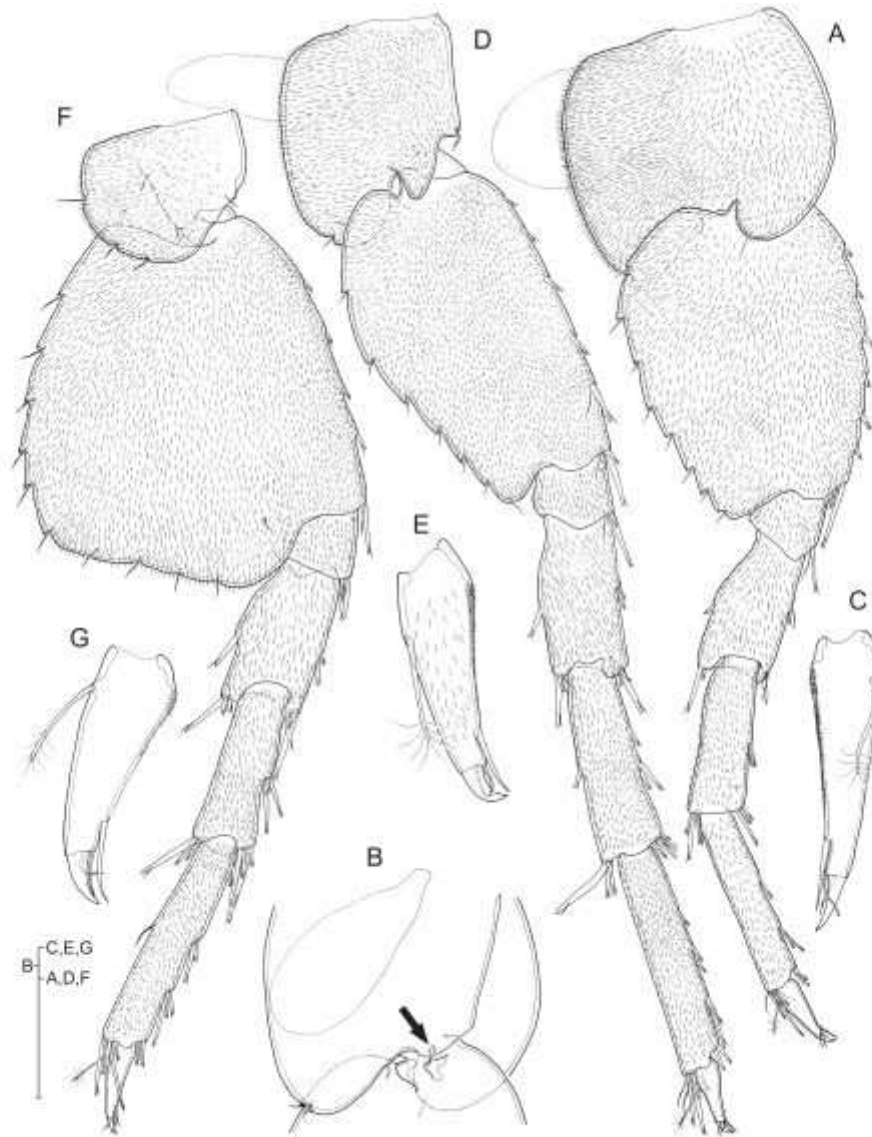

FIG. 8. – *Nixiani beatrix* n. sp., female holotype. A, right pereopod 5, lateral; B, detail of medial surface of coxa of left pereopod 5 (arrow points to "sternal gill" spine); C, detail of nail; D, right pereopod 6, lateral; E, detail of nail; F, right pereopod 7, lateral; G, detail of nail. Scale bars: 0.125 mm (A, B, D, F); 0.05 mm (C, E, G).

Pleopods (Fig. 9C-E) biramous, untransformed, protopods with pair of retinacles close to distomedial corner, and with presumed traces of intersegmental articulation proximally; nevertheless muscle signature not supporting subdivision of segment into coxa and basis. Outer margin of protopod of pleopods 1 and 3 with setulose outer margin, that of pleopod 2 apparently smooth. Protopod of pleopod 1 unarmed and slightly shorter than rest (Fig. 9C); that of pleopod 2 with 1 seta on anterior and 1 on posterior surface of segment (Fig. 9D); protopod of pleopod 3 with 2 setae on anterior surface and cluster of 3 setae on posterior surface of segment (Fig. 9E). Rami of pleopods about equal in length to corresponding protopod except pleopod 1, with rami longer than protopod.

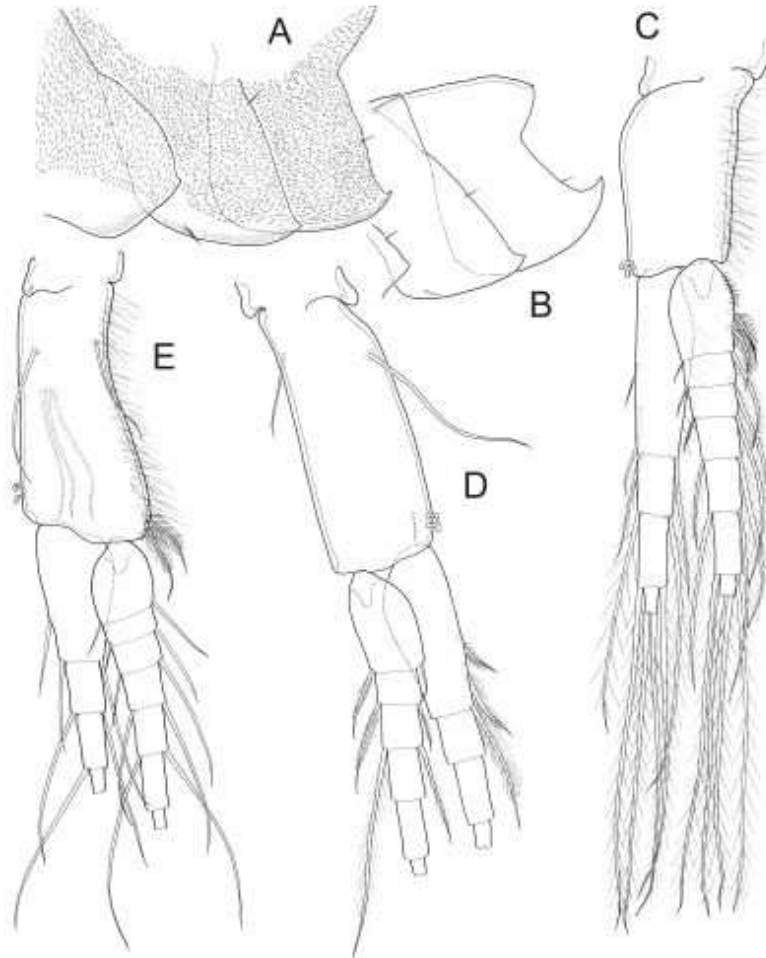

FIG. 9. – *Nuxanu beatrix* n. sp. A, left epimeral plates of female holotype, lateral; same for male paratype (integumental ornamentation omitted), C, left pleopod 1 of female holotype, anterior; D, right pleopod 2, anterior (setae on distal articles of rami omitted); E, left pleopod 3, anterior (setae on distal articles of rami and ornamentation of all ramal setae omitted).

Uropods progressively shorter towards posterior (Fig. 10A). First uropod (Fig. 10B, C) protopod with basofacial spine, 2-3 spines on outer margin, and 2 spines on inner margin; 2 unequal spines present on outer distal corner and 1 on inner distal corner of segment. Rami about equal in length, slightly shorter than protopod. Exopod with 1 spine at each margin; tip of segment with long spine and short penicillate seta flanged by 1 spine and 1 striated hyaline spine-like process at each side. Endopod similar to exopod except for presence of 2 spines on inner margin, 0-1 on outer margin, and absence of terminal penicillate seta. Second uropod (Fig. 10D) protopod shorter than rami, with 1 spine at each distal corner, inner spine shorter. Exopod shorter than endopod, with 1 short spine on inner margin and smooth outer margin; 1 stout spine flanged with 1 spine and 1 striated hyaline, spine-like process at each side on tip of segment. Endopod with 2 spines on outer margin and 3 on inner margin; tip of segment with same armature as exopod. Third uropod (Fig. 10E) protopod with 2 unequal distal spines on anterior margin and single distal spine on posterior margin; 1 seta and 1 distal

spine on medial margin of segment as figured. Exopod biramous, proximal segment longest, about as long as protopod, with single spine about midway of outer margin and 3 unequal spines distally; inner margin of segment with single spine distally. Distal segment about one-half length of preceding segment, tapering into bifid process. Endopod triangular, less than one-half length of proximal exopodal segment, with tiny subdistal spine. Telson (Fig. 10F) completely cleft, slightly broader than long, each lobe with 2 penicillate setae at about two-thirds of distance on outer margin, and another penicillate seta plus spine on tip.

Description of male

Apparently smaller than female (body length of single specimen available 2.48 mm). Identical in all respects to female except for second gnathopod (Fig. 6F), with comparatively shorter carpus (specially posterior margin of segment), and more oblique palm margin of propodus (palm angle at 57% length of segment). In addition, palm displaying higher number of unicuspid flagellar spines, and dactylus with 3 laminar spine-like processes on posterior margin, absent in female. Paired penile papillae not figured.

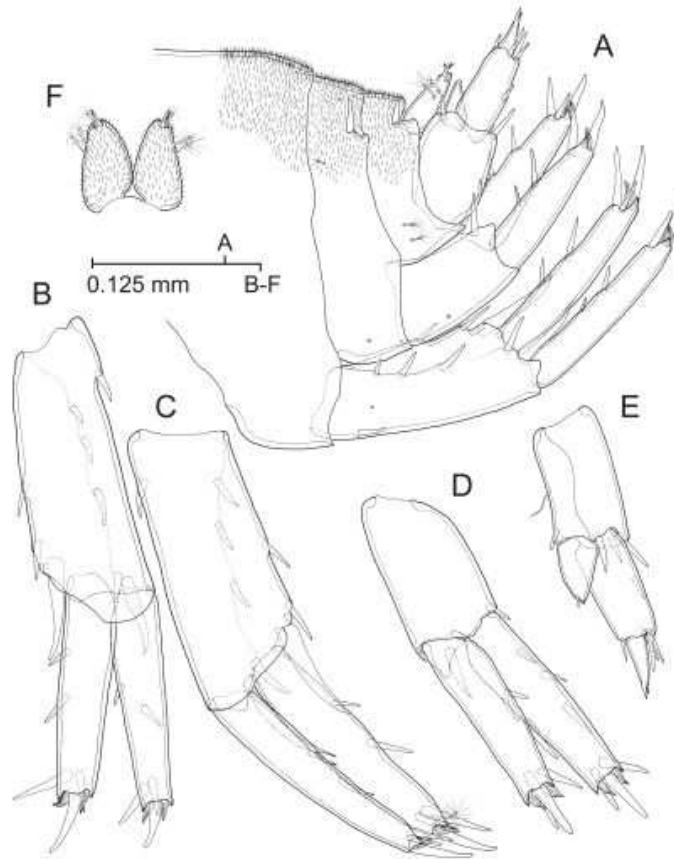

FIG. 10. – *Nuuanu beatrix* n. sp., female holotype. A, detail of urosome and telson, lateral (integumental ornamentation represented only on dorsal surface of urosomites and telson); B, left uropod 1, anterior; C, right uropod 1, medial; D, right uropod 2, anterior; E, right uropod 3, posterior; F, telson, dorsal (= posterior). Integumental ornamentation of uropods omitted.

Etymology

Species named after our laboratory colleague, Beatriz Morales Nin.

Remarks

The new taxon conforms precisely to the genus *Nuuanu* as recently redefined by Lowry and Watson (2002) based on the small body size, the poorly-developed eyes, the 3-articulate accessory flagellum, and the absence of dorsal keel on the first urosomite. Of the 10 species comprising the genus, only *Nuuanu garciai* shares with the new taxon the absence of dorsodistal spines on pleonites 1-2 and of posteroventral lobe on the posterior margin of coxa of pereopod 4. But the new species differs strikingly in other features. Namely: (1) second segment of mandibular palp with 2 setae (unarmed in *garciai*); (2) third segment with several D and 3 E setae (armature reduced to only 2 E setae in *garciai*); (3) posterior margin of basis of pereopod 5 convex (shallowly

excavated in *garciai*); (4) exopod of third uropod clearly longer than protopod (versus much shorter than protopod in *garciai*); and (5) telson with 1 distal spine on each lobe (unarmed in *garciai*), to mention only the most conspicuous differences.

The tiny spine present on the medial surface of coxa 5 (Fig. 8B) of the new species is similar, although more reduced, to that displayed in homologous position by *Nuuanu curvata* Vonk, 1988, which was tentatively considered by the latter author as a sternal gill. Vonk (1988) mentions it is displayed also by *Nuuanu numbadi* (Barnard, 1970) and by *Nuuanu muelleri* Ortiz, 1976, although the original description of the latter species (Ortiz, 1976) does not show nor mention anything about this. Descriptions of other *Nuuanu* species do not indicate whether this structure is present or not. Schellenberg (1930) was first to distinguish in amphipods between gills directly attached to the ventral part of the body (“Sternalkieme”), from the ordinary coxal (“Coxalkieme”) gills. It is worth mentioning that, at least in the new species, the spine is placed on the coxa and not on the sternite, and consequently it is hardly comparable to a true sternal gill. Even its form as an ordinary spine differs from those of sternal gills (see, for example, those figured in Ueno (1966: 511), or Holsinger (1977: 272). Sternal gills are reported to occur in amphipods of many families (e.g. Crangonyctidae Bousfield, 1973; Pseudocrangonyctidae Holsinger, 1989; Paramelitidae Bousfield, 1977; Neoniphargidae Bousfield, 1977; Hyalellidae Bulycheva, 1957; Paracrangonyctidae Bousfield, 1982; Bogidiellidae Hertzog, 1936), but we interpret the spiniform structure present on the medial surface of coxa 5 of some *Nuuanu* species as an ordinary spine. The presence of setae or spines on the medial surface of other pereopodal coxae of the new species lends additional support to this interpretation (notice, for example the tiny seta present proximally on the medial surface of coxae 1 and 2 (Fig. 5A, B), the slender subdistal flagellate spine on coxa 3 (Fig. 7A), or the 2 setae on coxa 7 (Fig. 8F).

Acknowledgements

This work has been supported by the project CAULEXPAN (REN2002-00701, Spanish Ministry of Science and Education) and the Taxonomic Clearing Facility of the EU Network of Excellence MARBEF.

References

- Barnard, J.L. and C.M. Barnard. – 1983. *Freshwater Amphipoda of the World*. Vol. I. Hayfield Associates, Virginia.
- Holsinger, J.R. – 1977. A review of the systematics of the Holartic amphipod family Crangonyctidae. *Crustaceana Suppl.*, 4: 244-281.
- Lowry, J. and M. Watson. – 2002. Revision of the Gammarellid group, with new species from the Andaman Sea (Crustacea, Amphipoda, Melitidae). *Phuket mar. biol. Centre Spec. Publ.*, 23(1): 197-212.
- Martí, A. and S. Villora-Moreno. – 1995. A new interstitial species of *Gammarella* (Amphipoda, Gammaridea) from the western Mediterranean Sea. *Contrib. Zool.*, 65: 18-200.
- Ortiz, M. – 1976. Un nuevo anfípodo (Amphipoda, Gammaridea, Gammaridae) colectado del contenido estomacal del Ronco Amarillo *Haemulon sciurus*, de aguas cubanas. *Ciencias. Serie 8. Investigaciones Marinas*, 27: 13-20.
- Schellenberg, A. – 1930. Sübwasseramphipoden der Falklandinseln nebst Bemerkungen über Sternalkiemen. *Zool. Anz.*, 91: 81-90.
- Uéno, M. – 1966. Results of the speleological survey in South Korea, 1966. II. Gammarid Amphipoda found in subterranean waters of South Korea. *Bull. Nat. Sci. Mus. Tokyo*, 9(4): 501-535.
- Vonk, R. – 1988. *Nuuanu curvata* n. sp. and *Melita leiotelson* n. sp. (Crustacea, Amphipoda) from beach interstitia on Curaçao. *Uitg. natuurw. Studkring Suriname*, 123:185-198.

5.4 Occurrence of *Automate branchialis* (Holthuis & Gottlieb, 1959) (Decapoda, Alpheidae) in the Balearic Islands (Western Mediterranean Sea)

The faunistic composition of Mediterranean marine ecosystems is still far from being well known, despite the intensive effort to increase our knowledge on the biodiversity all over the planet. Many marine ecosystems are as yet poorly understood, including even many sublittoral and shallow water areas. Decapod crustaceans constitute a relatively well studied faunistic group within the Mediterranean Sea (Zariquiey-Álvarez, 1968; d'Udekem d'Acoz, 1999). However, the Mediterranean is not a stable environment and it is a region with a strong faunistic influence both from the Atlantic Ocean in the west, through the strait of Gibraltar and also from the Indian Ocean and Red Sea in the east, since the opening of the Suez Canal in 1869.

Within the framework of a research project aiming to evaluate the effects of the colonization of the rhizomes of the seagrass *Posidonia oceanica* (L.) Delile by the macroalgals *Caulerpa*, specimens of decapod crustaceans were collected. Individuals were sampled from the sediment among the rhizomes of *P. oceanica* during 2003-2005 in Mallorca (fig. 1).

Infaunal communities were sampled with a square of 20 x 20 cm and a height of 5 cm, thus sampling a total volume of 2000 cm³, and sorted with 500 µm mesh. Four specimens of an alpheid shrimp, attributed to *Automate branchialis* Holthuis & Gottlieb, 1958 (Caridea, Alpheidae), were found at the rhizomes of *Posidonia oceanica* beds at Cala d'Or (Mallorca, Balearic Islands, western Mediterranean) (table I; fig. 1). No *Automate branchialis* were collected in the leaves stratum that was sampled with a hand-net of 20 x 40 cm along straight transects of 20 meters. Three of these specimens have been deposited in the Biological Collections of Reference of the Institut de Ciències del Mar (CSIC) under access codes ICMD 61-63/2006.

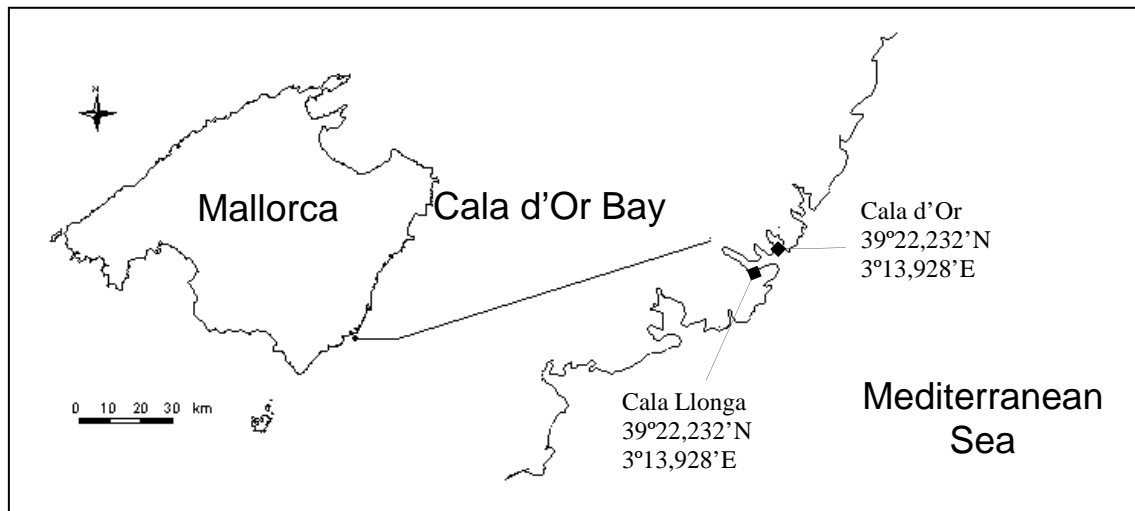

Fig 1. Localities of the present findings of *Automate branchialis* Holthuis & Gottlieb, 1958 in Mallorca, western Mediterranean Sea.

Fig. 2 and 3 show the relevant morphological details of the specimens that have allowed to identify them as *Automate branchialis*. Most morphological characters are in agreement with the original description of the species. However, Holthuis & Gottlieb (1958) stated that the outer margin of the scaphocerite ends in a distinct tooth, which is somewhat overreached by the lamella, as is clearly figured in their original description. This character was considered thus a valuable character to differentiate the species from some other species of the genus. However, in the individuals examined, the lamella does not overreach the spine (fig. 2 D, E).

Automate branchialis is a rare alpheid shrimp, described and initially recorded only from the eastern Mediterranean Sea. The present finding constitutes the second report of the species in the western Mediterranean, since Katagan & Kocatas (2001) made reference to an unpublished report by P. Noël where that author reports this species from Port-Cros, Marseille. All other records are restricted to the eastern Mediterranean Sea. The four individuals of *A. branchialis* found in our study constitute the western most record of the species, and considerably expand its known distribution range. Despite its description from the Mediterranean Sea, Holthuis & Gottlieb (1958) considered the possibility of the species being a Lessepsian colonizer (see also Galil, 1992), but it is currently considered a specie native to the Mediterranean basin (Katagan and Kocatas 2001). Its occurrence in the western Mediterranean provides further support to consider it an endemic Mediterranean specie, especially given the fact that no Lessepsian species has yet been recorded in the western basin of the Mediterranean.

The substrate where these organisms were found was characterized by colonization of the *Posidonia oceanica* meadows by the macroalgae, *Caulerpa prolifera* (Forsskal) Lamouroux and *Caulerpa taxifolia* (Vahl) C. Agardh. Concerning the microhabitat inhabited by *A. branchialis*, Dounas et al. (1992) stated that in Crete the species appeared frequently in a coastal silty-sand assemblage with *Caulerpa prolifera* (10-40 m), whereas Frogliá (1975) reported one specimen in the southwestern Adriatic Sea on sandy mud with dead *Posidonia* roots, and Koukouras et al. (1992) reported it from a substrate consisting of gravel and algae. In the Turkish Aegean Sea, individuals of *Automate branchialis* have been sampled in a *P. oceanica* meadow (Ates et al., 2004). The deepest individual recorded was found at a depth of 59 m at Malta (Števíć, 1979).

The lack of previous records in the Balearic Islands, and the scarceness of records elsewhere, may be linked to the type of substrate the species is known to inhabit, which is very infrequently sampled. All individuals recorded in this report were collected from among the rhizomes of *Posidonia oceanica* colonized by *Caulerpa prolifera* and *C. taxifolia*, except in one case where a single specimen was collected in a meadow of *P. oceanica* non-colonized by *Caulerpa* spp. (Table I). Our results and those reported in previous works may lead to conclude that the rhizomes and roots of *P. oceanica* constitute the main habitat for this infrequent alpheid species.

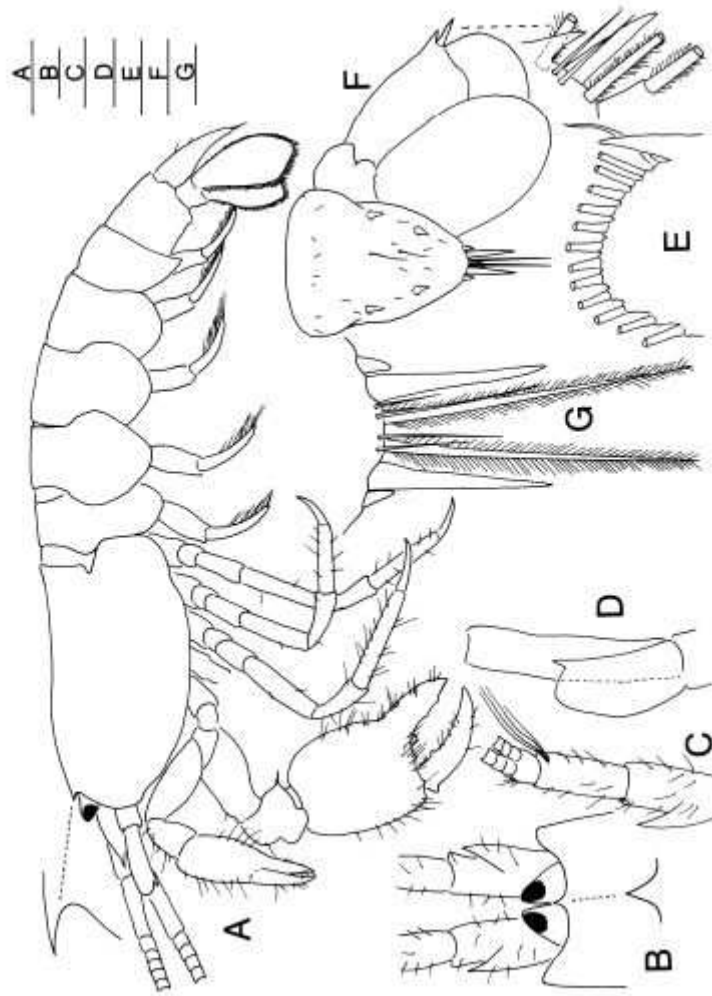

Fig 2. *Automate branchialis* Holthuis & Gottlieb, 1958. A, whole animal, lateral view; B, frontal margin of the carapace, dorsal view; C, antennule; D, antenna, with setation and flagellum omitted; E, anterior margin of scaphocerite, with setae truncated and setules omitted; F, detail of telson and uropods, with setation of uropods omitted; G, detail of posterior margin of telson. Scale bar S: A, 1 mm; B-D, F, 0.5 mm; E, 0.2 mm; G, 0.1 mm.

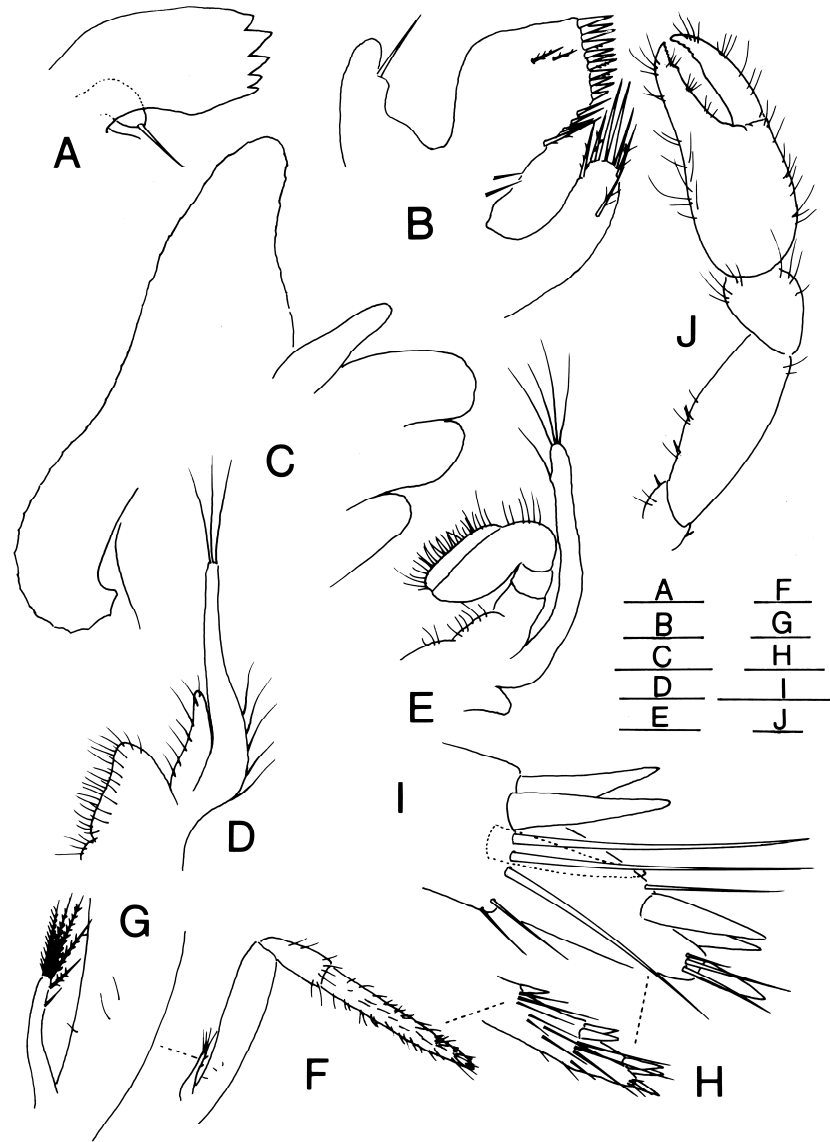

Fig 3. *Automate branchialis* Holthuis & Gottlieb, 1958. A, incisor process and palp of mandible; B, maxillule; C, maxilla, with setation omitted; D, first maxilliped; E, second maxilliped; F, third maxilliped; G, detail of endopod of third maxilliped; H, detail of endopod of third maxilliped; I detail of distal margin of endopod of third maxilliped. Scale bar S: A-C, 0.1 mm; D, G, H, J, 0.2 mm; E, 0.3 mm; F, 0.5 mm; I, 0.1 mm

Reference	Locality	Sampling date	Depth (meters)	Sampling gear	Habitat	N
1 Holthuis & Gottlieb (1958)	Israel coast	1954,1955,1956	18-73	grab-dredge	Sand, mud	19
2 Froglija (1975)	Adriatic Sea (Manfredonia Gulf)	1974	18	grab	Sandy, mud	1
3 Štević (1979)	Malta (35°59'04"N 14°27'05"E)	1965	59	grab	-	1
4 Koukouras et al.(1992)	Southern Aegean Sea ("Calypso" Sta.832)	1955	46	grab	Gravel	1
5 Dounas et al.(1992)	Southern Aegean Sea (Iraklion Bay)	1988-1991	10-40	grab	Silty sand	-
6 Noël (2001)	Port-Cros (Marseille)	1983	1.8		<i>Posidonia</i>	-
6 Noël (2001)	Port-Cros (Marseille)	1993	-		-	-
7 Katağan & Kocataş (2002)	North Aegean Sea (Izmir Gulf)	1996	30	grab	Sand	1
7 Katağan & Kocataş (2002)	North Aegean Sea (Izmir Gulf)	2000	35	grab	Sand	1
7 Katağan & Kocataş (2002)	Cyprus (Magosa Bay)	1997	37	Trawl	Mud	1
8 Present study	Mallorca (Cala Llonga)	07/vii/2003	6	SCUBA	<i>Caulerpa prolifera</i>	1
8 Present study	Mallorca (Cala d'Or)	11/x/2004	9.8	SCUBA	<i>Caulerpa taxifolia</i>	1
8 Present study	Mallorca (Cala d'Or)	11/x/2004	10	SCUBA	<i>Posidonia oceanica</i>	1
8 Present study	Mallorca (Cala d'Or)	24/ii/2005	9.8	SCUBA	<i>Caulerpa taxifolia</i>	1

Table 1: Previous (cf Katağan & Kocataş, 2001) and present records of *Automate branchialis*_Holthuis & Gottlieb, 1958 in the Mediterranean Sea . N, number of individuals recorded.

Aknowlegements

This research was funded by the Ministerio de Ciencia y Tecnologia (Plan Nacional I+D (REN2002-00701/MAR)). The first author was funded by postgraduate research grant I3P FSE. We are most grateful to Dr. Bella Galil for her help in locating all relevant references as well as for her comments.

References

- ATES, A. S., T. KATAĞAN & A. KOCATAŞ. 2004. Decapod fauna of shallow water Posidonia oceanica (L.) Delile, 1813 meadows in the Aegean Sea coasts of Turkey. Ege University Journal Fish. aquat. sci., **21**(1-2): 39-42.
- DOUNAS, C., C. SMITH, N. LAMPADARIOU & A. ELEFThERIOU, 1992. Community structure and seasonal changes of the decapod crustacean fauna in the Cretan continental shelf. Proceedings of the First European Crustacean Conference Paris, August 31-September 5, 1992. Muséum National d'Histoire naturelle, Paris:48.
- FROGLIA, C., 1975. The occurrence of Automate branchialis Holthuis & Gottlieb (Decapoda, Alpheidae) in the Adriatic Sea. Crustaceana, **29**(3): 308-309.
- GALIL, B. S., 1992. Eritrean decapods in the Levant. Biogeography in motion. Bulletin Institut. océanographique., Monaco, spec. no 9: 115-123.
- GALIL, B. S., C. FROGLIA & P. NOËL, 2002. CIESM atlas of exotic species in the Mediterranean. 2. Crustaceans: 1-192, (CIESM Publishers, Monaco).
- HOLTHUIS, L. B. & E. GOTTLIEB, 1958. An annotated list of the decapod Crustacea of the Mediterranean coast of Israel with an appendix listing the Decapoda of the eastern Mediterranean. Bulletin Research Council Israel, **7**(1-2): 1-126.
- KATAĞAN, T. & A. KOCATAŞ, 2001. New localities for Automate branchialis Holthuis & Gottlieb, 1958 (Decapoda, Alpheidae) in the Mediterranean Sea. Crustaceana **74**: 1387-1391.
- KOCATAŞ, A. & T. KATAĞAN, 1994. Impact of Lessepsian decapod and stomatopod species on the biodiversity of Turkish sea. Ulusal Biyol. Kongr., 6-8 Temmuz, Edirne:290-294 [In Turkish].
- KOUKOURAS, A., C. DOUNAS, M. TURKAY & E. VOULTSIADOU-

- KOUKOURA, 1992. Decapod crustacean fauna of the Aegean Sea: new information, check list, affinities. *Senckenbergiana marit*, **22**(3/6): 217-244.
- ŠTEVČIĆ, Z., 1979. "Contribution à la connaissance des Crustacés Décapodes de Malta." *Comm. int. Mer Méditerranéen* **25/26**(4): 127-128.
- ŠTEVČIĆ, Z. 2002. New observations on the Adriatic decapod fauna (years 1990-2000). *Crustaceana*, **75**(3-4): 643-647.
- UDEKEM D'ACQZ, C. d', 1999. Inventaire et distribution des crustacés décapodes de l'Atlantique nord-oriental, de la Méditerranée et des eaux continentales adjacentes au nord de 25°N. *Muséum national d'Histoire naturelle, Patrimoines naturels*, **40**: 1-383.

5.5 Resumen de cambios en la comunidades de invertebrados

- La presencia de algas del género *Caulerpa* implica cambios en las abundancias de poliquetos, crustáceos, moluscos, sipuncúlidos y equinodermos.
- A lo largo del estudio se han identificado un total de 72 especies de poliquetos, 53 de moluscos, 68 crustáceos (33 decápodos, 33 anfípodos, 2 anisópodos), 2 sipuncúlidos y 10 equinodermos, lo que supone un total de 205 especies identificadas repartidas entre *Caulerpa prolifera*, *C. taxifolia*, *C. racemosa* var. *cylindracea* y *Posidonia oceanica*.
- Las áreas con presencia de *Caulerpa prolifera* y *C. racemosa* var. *cylindracea* tienen una comunidad de invertebrados más diferenciada de *Posidonia oceanica*. Estas diferencias se producen en *C. prolifera* por las mayores abundancias de moluscos y en *C. racemosa*, por las mayores abundancias de crustáceos, en concreto, de decápodos y anisópodos.
- *Caulerpa taxifolia*, presenta unas abundancias y porcentajes de crustáceos, poliquetos y moluscos similares a *Posidonia oceanica*. Esta caulerpal a pesar de estar presente desde 1992 en aguas de Mallorca no presenta gran capacidad invasora (sólo es presente en Cala d'Or). De ahí su escaso impacto en el ecosistema tanto por su presencia vegetada como por sus efectos sobre invertebrados, menores que las otras dos caulerpales.
- La abundancia de invertebrados en las tres caulerpales son superiores respecto *Posidonia oceanica*, pero ha de tenerse presente que las praderas de *Posidonia oceanica* son un ecosistema muy complejo y rico en especies (Chessa et al. 1989; Gambi et al. 1992; Lepoint et al. 1999; Barbera-Cebrian et al. 2002; Gallmetzer et al. 2005). La metodología de muestreo no es la más apropiada para el estrato folial y los resultados se refieren principalmente a la infauna.
- La riqueza de especies es en general superior en las tres especies de *Caulerpa*. En las muestras recogidas en *Caulerpa* interaccionan varios efectos como la proximidad

de praderas de *Posidonia oceanica*, la no formación de praderas monoespecíficas, efecto borde de la pradera de *P. oceanica* (Sánchez-Jerez et al. 1999b), la mata muerta como sustrato (Borg et al. 2006), la cobertura con su efecto barrera del sustrato por *Caulerpa* (Longepierre et al. 2005) y movimientos horizontales de invertebrados (Buschman 1990) son factores a considerar para explicar la mayor diversidad de especies en *Caulerpa*.

- El estrato rizomático de *Posidonia oceanica* está poco estudiado y debemos destacar las nuevas especies y citas de invertebrados encontradas. Toda la información recogida contribuye a aumentar el conocimiento de la fauna del litoral balear.

Capítulo 6

CAULERPENINA Y DEFENSAS ANTIOXIDANTES

CAULERPENYNE AND ANTIOXIDANT DEFENCES

Capítulo adaptado de:

Seasonality of caulerpenyne contents in the native *C. prolifera* and the invasive *C. taxifolia* and *C. racemosa* var *cylindracea* in the Western Mediterranean. Authors: Box, A., Sureda, A., Tauler, P., Terrados, J., Marbà, N., Pons, A. and Deudero, S. In prep

Enzymatic antioxidant response of a labrid fish (*Coris julis*) liver to environmental caulerpenyne. Comparative Biochemistry and Physiology. Part C 144(2006) 191-196. Authors Sureda, A., Box, A., Enseñat, M., Alou, E., Tauler, P., Deudero, S. and Pons, A.

Reciprocal effects of caulerpenyne and intense herbivory on the antioxidant response of *Bittium reticulatum* and *Caulerpa taxifolia*. Ecotoxicology and Environmental Safety, In Press. Authors: Sureda, A., Box, A., Deudero, S. and Pons, A.

Antioxidant response and caulerpenyne production of the alien *Caulerpa taxifolia* (Vahl) C. Agardh epiphytized by the invasive algae *Lophocladia lallemandii* (Montagne). Submitted 19, October 2007 to Journal of Experimental Marine Biology and Ecology. Under Review. Authors Box, A., Sureda, A., Terrados, J., Pons, A. and Deudero, S.

6.1 Introducción al capítulo

En el presente capítulo se exponen una serie de experimentos dirigidos a observar como afectan las especies invasoras en la fauna de las zonas invadidas. La abundancia de las diferentes especies de invertebrados aumentan o disminuyen como muestran los estudios faunísticos realizados. Para poder comprender el aumento o descenso de las especies y tras una consulta de la literatura existente, se pensó en la aplicación de biomarcadores de estrés oxidativo como herramienta para analizar estos cambios. Para el desarrollo del capítulo con una mayor componente de bioquímica se diseñaron los siguientes experimentos:

- Variaciones anuales de caulerpenina en *Caulerpa prolifera*, *C. racemosa* y *C. taxifolia*.
- Respuesta antioxidante de *Coris julis* ante la caulerpenina ambiental.
- Efectos de la herbivoría del gasterópodo *Bittium reticulatum* sobre *C. taxifolia*.
- Interacción entre dos especies invasoras *C. taxifolia* y *Lophocladia lallemandii*.

El objetivo del presente capítulo es ver la aplicabilidad y valoración de técnicas bioquímicas para interpretar la respuesta de los organismos ante la presencia de las algas del género *Caulerpa* como herramienta para comprender los cambios en la respuesta del bentos.

Seasonality of caulerpenyne contents in the native *C. prolifera* and the invasive *C. taxifolia* and *C. racemosa* var *cylindracea* in the Western Mediterranean

En el primero de los trabajos desarrollados, se ha medido la variación anual de caulerpenina en las tres especies de caulerpales presentes en Baleares. En la literatura disponible hasta el momento, siempre se ha considerado la caulerpenina como el principal metabolito secundario de las caulerpales responsable de una inhibición de la herbivoría por parte de los invertebrados bentónicos.

A lo largo de un año completo, con una periodicidad mensual, se han recogido muestras de *Caulerpa prolifera*, *C. taxifolia* y *C. racemosa* var. *cylindracea* en la Isla de Mallorca. Las muestras han sido cuidadosamente procesada según el protocolo de Amade and Lemee (1998) y la caulerpenina ha sido cuantificada mediante High Precision Liquid Chromatography (HPLC).

Enzymatic antioxidant response of a labrid fish (*Coris julis*) liver to environmental caulerpenyne

El segundo trabajo que presentamos en este capítulo se estudia la toxicidad de las caulerpales sobre el pez *Coris julis*. Para ello, se han estudiado las defensas antioxidantes y daño oxidativo de *C. julis* en dos praderas de caulerpales con diferencias significativas en su concentraciones de caulerpenina además de una zona control con la fanerógama *Posidonia oceanica*. Amade (1994) demostró que en el agua circundante a los frondes de *Caulerpa taxifolia* la caulerpenina está presente a pesar de su degradación en contacto con el agua de mar. Bajo esta premisa, todos los organismos que viven asociados a la caulerpales se verán afectados por esta caulerpenina ambiental.

Se ha seleccionado *Coris julis* para el estudio de estrés oxidativo ya que la presencia de *Caulerpa taxifolia* parece favorecer la presencia de este lábrido (Francour 1997) y también por sus hábitos sedentarios y de escaso movimiento (Michel et al., 1987). Refuerza la elección de esta especie las coloraciones miméticas que desarrollan al vivir en un entorno colonizado por *C. taxifolia*, donde aumentan las coloraciones verdes (Arigoni et al. 2002). *Coris julis* es una especie de lábrido principalmente carnívora, por lo tanto solo ingerirá accidentalmente fragmentos de *Caulerpa* y se verá expuesta a la caulerpenina y derivados presente en sus presas y la caulerpenina ambiental.

Para la realización del presente estudio se capturaron ejemplares de *Coris julis* en una zona de *Caulerpa prolifera*, otra de *C. taxifolia* y una zona control de *Posidonia oceanica*. Después de seleccionar ejemplares de un mismo tamaño se procedió a la evaluación de enzimas antioxidantes en *C. julis* y a la determinación de caulerpenina en las dos caulerpales.

Reciprocal effects if caulerpenyne and intense herbivorism on the antioxidant response of *Bittium reticulatum* and *Caulerpa taxifolia*

Bittium reticulatum es un pequeño gasterópodo cuya alimentación se basa en algas y detritus. El aumento de dicha especie observado durante el trabajo de campo en sus abundancias en zonas invadidas por *C. taxifolia* hace pensar en la posibilidad que este gasterópodo mesoherbívoro sea capaz de ingerir *Caulerpa* y adaptarse a los hábitats con caulerpenina ambiental. Bajo la hipótesis de un incremento de defensas antioxidantes pero no de daño oxidativo en *Bittium reticulatum* pretendemos explicar el “no descenso” en sus abundancias en las zonas invadidas por caulerpales.

Por otro lado, se analiza la respuesta de *Caulerpa* ante una situación de herbivorismo inducido. Partiendo de la hipótesis ya demostrada para otras algas (Erickson et al. 2006) de un aumento de los metabolitos secundarios frente a situaciones de herbivorismo, se pretende demostrar éste en *C. taxifolia* (aumento de caulerpenina) además de la respuesta fisiológica que experimenta el alga frente a su consumo directo.

En condiciones controladas (acuarios) se prepararon varios tratamientos tales como *Caulerpa taxifolia* sola, *C. taxifolia* con *Bittium reticulatum* y *Bittium reticulatum* con *Posidonia oceanica* para medir la respuesta antioxidante de *Bittium* y la producción de caulerpenina bajo presión de herbívoros.

Antioxidant response and caulerpenyne production of the alien *Caulerpa taxifolia* (Vahl) C. Agardh epiphytized by the invasive algae *Lophocladia lallemandii* (Montagne)

La especie invasora *Lophocladia lallemandii* se introdujo en el Mediterráneo a través del Canal de Suez (Boudouresque and Verlaque 2002). Al igual que *Caulerpa taxifolia* posee sustancias tóxicas para evitar el consumo de sus estructuras como son lofocladinas y alcaloides (Gross et al. 2006). Se trata de una especie con gran capacidad invasora que, en la actualidad, esta colonizando grandes extensiones a lo largo del litoral balear. Esta especie de alga crece sobre todo tipo de sustratos, rocas desnudas, comunidades rocosas de macroalgas, *Posidonia oceanica* y sobre comunidades de coralígeno (Patzner 1998; Ballesteros 2006).

En la zona de Cala d'Or, nos encontramos ante la coincidencia de dos especies invasoras, *Caulerpa taxifolia* y *Lophocladia lallemandii*, en una situación de competencia por el sustrato, que en este caso son los rizomas de *Posidonia oceanica*. Además de competir por el sustrato, visualmente comprobamos como *L. lallemandii* es

capaz de epifitar a *C. taxifolia*, lo que hace pensar que *L. lallemandii* es capaz de detoxificar la caulerpenina. Los frondes epifitados por *L. lallemandii* muestran un cambio de morfología (frondes más pequeños y compactos) y una degradación de tejidos.

A partir de esta observación pretendemos demostrar la hipótesis que *Lophocladia lallemandii* provoca daño oxidativo a *Caulerpa taxifolia* además de provocarle un aumento de la caulerpenina.

6.2 Seasonality of caulerpenyne contents in the native *Caulerpa prolifera* and the invasives *Caulerpa taxifolia* and *Caulerpa racemosa* var *cylindracea* in the Western Mediterranean

Abstract

The presence of three *Caulerpa* (*C. prolifera*, *C. taxifolia* and *C. racemosa*) species in the Balearic Islands allows to evaluate the differences across species in caulerpenyne concentrations in the same growing conditions. The established *C. prolifera* was the species with higher caulerpenyne contents (83.91 ± 10.75 μg caulerpenyne/ mg algae DW) compared with the invasive algae *C. taxifolia* (43.02 ± 6.31 μg caulerpenyne /mg algae DW) and *C. racemosa* var *cylindracea* (16.27 ± 4.24 μg caulerpenyne /mg algae DW). The three *Caulerpa* species showed different caulerpenyne seasonal trends in fronds and stolons. *C. prolifera* showed lower contents from May to October in fronds and not clear seasonal pattern in stolons. The invasive *C. taxifolia* reach maximum caulerpenyne value in fronds in May decreasing slightly until winter and not showing clear seasonal trends in stolons. The contents of caulerpenyne in fronds of *C. racemosa* var *cylindracea* remain relatively constant through the year and stolons showed a clear seasonal pattern increasing caulerpenyne contents in spring reaching maximum values at the end of summer and decreasing during winter. In *C. prolifera* caulerpenyne contents were positively correlated with densities of the *Caulerpa* feeder gastropod *Ascobulla fragilis* ($\text{Rho} = 0.837$, $p < 0.05$). The three *Caulerpa* showed differences in caulerpenyne concentration and in the degree of protection of their thallus parts. It is also important to remark that other factors, not caulerpenyne, were responsible for the widespread in the Mediterranean of invasive *Caulerpa*

Keywords: *Caulerpa*, chemical defense, caulerpenyne, Balearic Islands, Western Mediterranean

Introduction

The presence of introduced species in marine ecosystems is an increasing problem around the world and is related to the development of international shipping, aquaculture, aquarium trade (Verlaque and Fritayre 1994; Boudouresque et al. 1995; Boudouresque 1998; Boudouresque and Verlaque 2002). In the Mediterranean sea the Suez Channel opening is most important species introduction vector (Galil 2007). When an introduced species is able, not only to establish as viable, self-sustaining population outside its native area spread and be able to modify the structure of the invaded ecosystems causing ecological and/or economic impacts the introduced species is considered invasive (Sakai et al. 2001; Boudouresque and Verlaque 2002). The escape from biotic constraints (competitors, predators, grazers, parasites) may be one of the mechanisms by which introduced species become successful invaders (Mack et al. 2000; Sakai et al. 2001).

Several macroalgae can deter herbivores by using chemical defenses (Hay and Fenical 1988; Erickson et al. 2006). The species of the order Caulerpales (Chlorophyta) produce sesquiterpenoid and diterpenoid compounds which are toxic and actively deter generalist herbivores (Paul and Fenical 1986; Hay and Fenical 1988; Paul and Vanalstyne 1992). Caulerpenyne is a secondary metabolite synthesized by the species of the genus *Caulerpa* which plays a major role in their chemical defence (Paul and Fenical 1986; Pohnert and Jung 2003). The main function of caulerpenyne production is the defence of the algae against epyphites and herbivorism (Erickson et al. 2006). Caulerpenyne has also cytotoxic effects in mammalian cells (ParentMassin et al. 1996; Barbier et al. 2001), inhibits the growth of marine fungi (Paul and Fenical 1986), interferes with the sexual reproduction of sea urchins at different stages (Paul and Fenical 1986; Lemee et al. 1996; Pesando et al. 1996), deters the herbivory by gastropods and fishes, and is toxic to fishes as well (Paul and Fenical 1986). There are examples, however, where caulerpenyne did not deter fish herbivory (Meyer and Paul 1992) which indicates that toxicity of caulerpenyne is not intrinsic of the compound but a result of metabolite-consumer interactions (Paul 1992). Recent studies demonstrated that caulerpenyne is transformed into the most toxic and deterrent oxytoxins when the algae are wounded (Gavagnin et al. 1994; Jung and Pohnert 2001). For instance, caulerpenyne has been shown to be an inductor of increased antioxidant response in the Mediterranean labrid *Coris julis* (Sureda et al. 2006).

Three species of *Caulerpa* are present in the Western Mediterranean, *Caulerpa prolifera* (Forsskal) Lamouroux, *Caulerpa taxifolia* (Vahl) C. Agardh, and *Caulerpa*

racemosa var. *cylindracea* (Sonder) Verlaque, Huisman et Boudouresque. *C. prolifera* is a native species which is widely distributed throughout the Mediterranean Sea. An aquarium-maintained strain of *C. taxifolia* was introduced in the Mediterranean Sea in 1984 (Meinesz and Hesse 1991) and rapidly spread by the Western Mediterranean (Meinesz et al. 2001). This species seems to interfere with the vegetative development of the seagrass *Posidonia oceanica* L. Delile (Devillele and Verlaque 1995; Dumay et al. 2002) and reduces the algal diversity of the invaded communities (Balata et al. 2004; Verlaque et al. 2004) and has thereby greatly altered the Mediterranean shallow benthic communities in certain locations (Meinesz et al. 1993; Meinesz 2004). *C. racemosa* has been present in the Eastern Mediterranean Sea since the early 20th century, likely introduced from the Red Sea through the Suez Channel. But is the invasive *C. racemosa* var. *cylindracea* variety, originary from South West Australia (Verlaque et al. 2003), which has rapidly spread throughout the Western Mediterranean during the last twenty years (Verlaque et al. 2000) and even reached the Canary Islands in the Atlantic (Verlaque et al. 2004). *C. racemosa* var. *cylindracea* affects the development of seagrasses (Ceccherelli and Campo 2002; Dumay et al. 2002) and reduces the species richness, reduces diversity of macroalgae in the invaded communities (Piazzi et al. 2001a; Balata et al. 2004) and changes benthic invertebrate communities (Argyrou et al. 1999; Buia et al. 2001).

The aim of this study was to compare the caulerpenyne content of the native *Caulerpa prolifera* with those of the two invasive species of *Caulerpa* present in the Mediterranean Sea (*C. taxifolia* and *C. racemosa* var. *cylindracea*). We estimated the contents of caulerpenyne at monthly intervals during one year considering that previous studies showed that the content of caulerpenyne changes seasonally in *Caulerpa* spp (Amade and Lemee 1998; Dumay et al. 2002) and evaluated its coupling to seasonal forcing, reflected by seawater temperature, the biomass of *Caulerpa*, and the abundance of *Caulerpa*-specialized herbivores. The study was performed in three mixed *Caulerpa*-*Posidonia oceanica* meadows in Mallorca (Balearic Islands, Western Mediterranean), all experiencing a similar seasonal forcing.

Materials and methods

Sampling locations

Samples of *Caulerpa* species were collected monthly from November 2004 to October 2005 in Mallorca (Balearic Islands, Western Mediterranean). Because the three *Caulerpa* species do not co-occur at any location in the island we chose two sampling locations: *C. taxifolia* and *C. prolifera* were collected in Cala D'Or Bay, Southeast Mallorca (N 39° 22.164' / E 3° 13.887' and N 39° 22.028' / E 3° 13.739', respectively), and *C. racemosa* var. *cylindracea* was collected in Portals Vells Bay, Southwest Mallorca (N 39° 28.321' / E 2° 31.320'). Both bays are facing East, and all the *Caulerpa* samples were collected at depths of 4-8 m over the rhizome mat of the seagrass *Posidonia oceanica*. Seawater temperature was recorded by StowAway[®] Tidbit[®] (Onset Computer Corporation, Pocasset, MA, USA) temperature loggers installed permanently at the sampling depth in both bays.

Extraction and quantification of caulerpenyne

Caulerpa spp were carefully hand-collected by scuba-divers to prevent the transformation of caulerpenyne into reactive aldehydes driven by the fragmentation of the thallus (Gavagnin et al. 1994; Jung and Pohnert 2001). The algal material was maintained in fresh sea water at ambient temperature until the extraction of caulerpenyne which was done within 1 hour from collection. In the laboratory, *Caulerpa* fragments were quickly washed in freshwater to remove external salt, dried with absorbent paper, and the fronds and stolons were separated. Five g (fresh weight) of algal material were placed in 50 mL of methanol to obtain the crude methanolic extract, and each sampling date five extracts (replicates) of each *Caulerpa* species and algal part (frond, stolon) were prepared. In addition, five replicate samples of 5 g (fresh weight) of each *Caulerpa* species were dried at 70 °C for 24 hours to estimate the ratio wet weight/dry weight and be able to compare the concentrations of caulerpenyne that were measured with the values reported in the literature.

The methanolic extracts were filtered through silica columns and eluted with 5 mL of a mixture of methanol/ethyl acetate (50:50). The concentration of caulerpenyne was determined using an HPLC method. The mobile phase consisted of 80:20 methanol/H₂O. The HPLC was a Shimadzu with a diode array detector and the column was Nova Pak, C18, 3,9x150mm. Caulerpenyne was determined at 254 nm and quantified by comparison to a standard curve of known concentration prepared with .

pure caulerpenyne provided by Dr. Amade P. (Equipe antitumoraux Naturels, Université Nice, Sophie Antipolis).

Biomass of *Caulerpa* and abundance of *Caulerpa*-specialized herbivores

Six quadrats of 20 x 20 cm were collected each sampling date in 100% cover patches of each *Caulerpa* species by hand by SCUBA divers. The algal material was sorted into fronds and stolons and dried for 48 h at 70°C to express biomass as dry weight. To estimate the abundance of *Caulerpa*-specialized herbivores three additional samples were collected from November 2004 to August 2005 in 100% cover patches of each *Caulerpa* species using a 20 x 20 cm bottom-less stainless steel box that was inserted 5 cm into the substratum. The whole content of the box was transferred to a 500 µm mesh bag, washed with sea water, and sorted under a dissecting binocular scope.

Statistical analysis

Statistical analysis were carried out using the statistical package SPSS 14.0 for Windows. The statistical significance of the differences between the concentration of caulerpenyne in the fronds and stolons of the three *Caulerpa* species was evaluated using the ANOVA for two groups test, while two-way ANOVA was used to test for significant differences in the content of caulerpenyne between *Caulerpa* species and sampling dates for each thallus part (frond, stolon).

The relationship among the biomass and the concentration of caulerpenyne in the thallus part of each *Caulerpa* species and seawater temperature was evaluated by performing a linear correlation (Pearson) analysis. The relationship between the abundance of *Ascobulla fragilis* in *C. prolifera* and the biomass and caulerpenyne content of this species was also evaluated by linear correlation. Pearson correlations of caulerpenyne concentration between *Caulerpa* species were also used to evaluate the temporal coherence of the concentration of caulerpenyne among species.

Results

The average (± 1 SE) biomass of the *Caulerpa* meadows was 83.91 ± 10.75 g/m² for *Caulerpa prolifera*, 43.02 ± 6.31 g/m² for *C. taxifolia* and 16.27 ± 4.24 g/m² for *C. racemosa* var. *cylindracea*. Both stolon and frond biomass of all *Caulerpa* species exhibited temporal changes during our study. *C. prolifera* biomass remained low during the summer months, and increased during autumn and winter months to reach maximum values in spring (Fig 1 a, b.) The biomass of *C. taxifolia* fronds showed a clear seasonal pattern decreasing from the end of summer to reach minimum values at the end of spring. The biomass of *C. taxifolia* stolons was higher in winter and summer months than in the rest of the year (Fig. 1c, d). *C. racemosa* var. *cylindracea* biomass showed a clear seasonal pattern with maximum biomass values in August both for fronds and stolons. The biomass of this species showed a distinct seasonal cycle with undetectable biomass during winter, increasing during spring to reach maximum value in August decreasing afterwards (Fig 1d, f)

The content of caulerpenyne was different between *Caulerpa* species, part of the thallus, and sampling dates (Tables 1, 2). *Caulerpa taxifolia* and *C. racemosa* var. *cylindracea* had higher content of caulerpenyne in fronds than in stolons while in *C. prolifera* the content of caulerpenyne was higher in stolons than in fronds (Table 1). The content of caulerpenyne in fronds was higher in *C. taxifolia* than in *C. prolifera*, and it was lowest in *C. racemosa* var. *cylindracea*. The content of caulerpenyne in stolons, however, decreased from *C. prolifera* to *C. taxifolia*, and *C. racemosa* var. *cylindracea* (Table 1).

The content of caulerpenyne in fronds of *Caulerpa prolifera* was lower from May to October than during the rest of the year, while the content of caulerpenyne in the stolons showed no clear seasonal pattern (Fig. 2 a, b). None of the correlations among biomass and caulerpenyne content in the fronds and stolons of this species and temperature of the water were significant (Table 3).

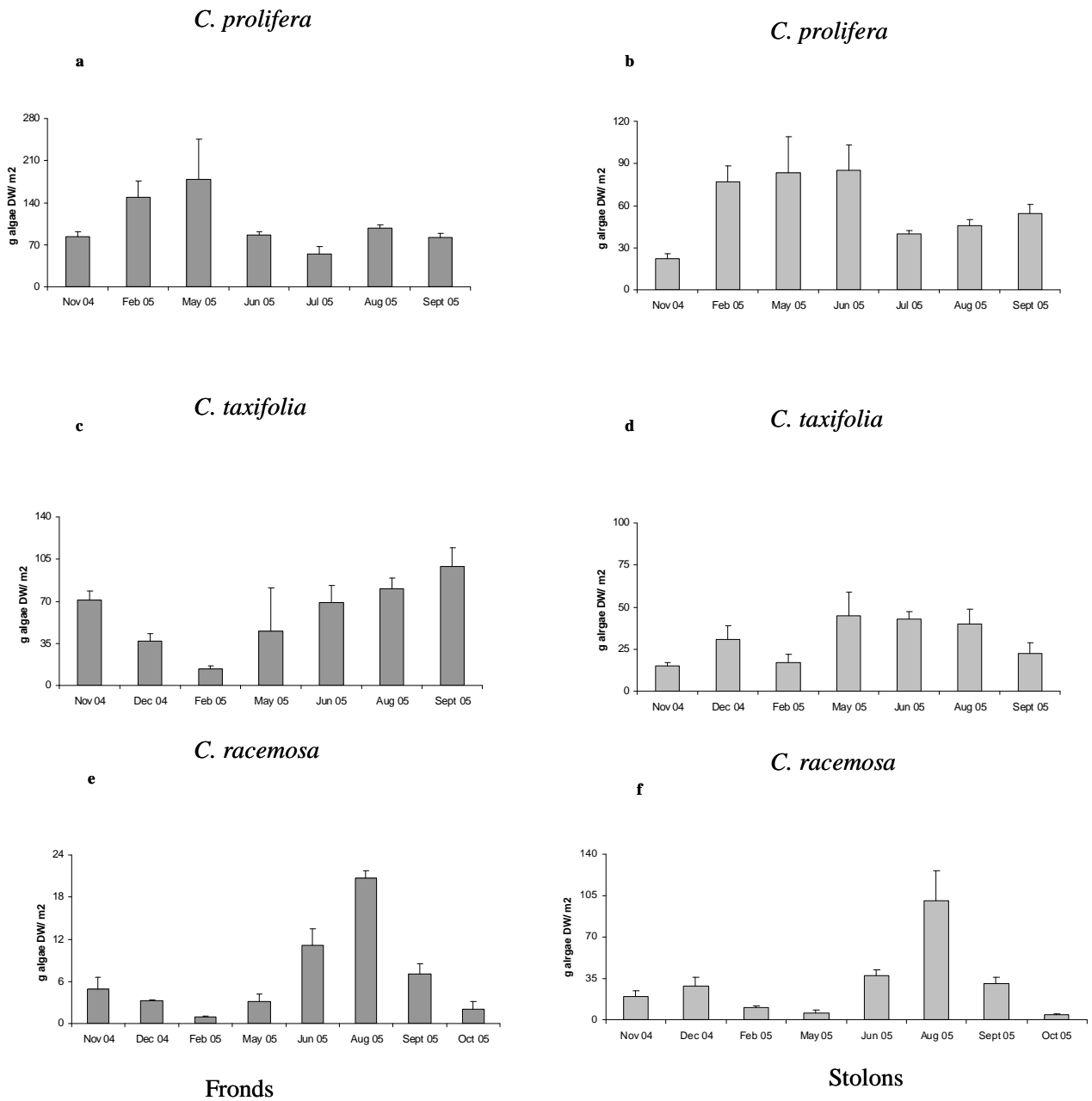

Figure 1: Biomass of fronds (left panels, a,c,e) and stolons (right panels, b, d,f) of three *Caulerpa* species in Mallorca (Western Mediterranean) from November 2004 to October 2005. The error bars represent +1 SE.

The content of caulerpenyne in fronds of *Caulerpa taxifolia* reached a maximum value in May and decreased slowly during summer and autumn to reach a minimum value at the end of winter. Except for the relatively high values in April, September, and October, the content of caulerpenyne in the stolons of this species did not change during the year (Fig. 2 c, d). The content of caulerpenyne in fronds of *C. taxifolia* was positively correlated with the water temperature but not with frond biomass (Table 3). The content of caulerpenyne in the stolons was correlated neither with temperature with stolon biomass.

The content of caulerpenyne in fronds of *Caulerpa racemosa* var. *cylindracea* remained relatively constant during the year except for a high value recorded in October. However, the caulerpenyne contents in stolons showed clear seasonal pattern, increasing in spring to reach maximum values at the end of summer-autumn and minimum values during winter (Fig. 2 d, f). The content of caulerpenyne in the stolons of this species was positively correlated with the water temperature and was not correlated neither with biomass nor with water temperature in the fronds (Table 3).

Table 1: [CYN] means concentration in *Caulerpa* species ($\mu\text{g CYN /mg alga DW} \pm$ standard error). Post hoc DMS results compares [CYN] to each tissue among meadows, different symbols (#, *, +) mean different groups; *** means significant differences between *Caulerpa* sp. thallus parts (ANOVA $p < 0.01$), n. s means no significant differences between *Caulerpa* sp. thallus parts.

<i>Caulerpa</i> spp.	Thallus part		
	<i>Frond</i>	<i>Stolon</i>	
<i>C. prolifera</i>	46.35 \pm 2.51 [#]	72.92 \pm 6.44 [#]	***
<i>C. taxifolia</i>	54.70 \pm 3.21 [*]	12.73 \pm 0.37 [*]	***
<i>C. racemosa</i>	4.31 \pm 0.79 ⁺	2.97 \pm 1.30 [*]	n.s

Table 2: Two-way ANOVA (factors *Caulerpa* sp. and time) for fronds and stolons; *** means significant differences between *Caulerpa* sp. thallus parts (ANOVA p<0.01)

	Thallus part			
	Fronds		Stolons	
Source of variation	Df	MS	Df	MS
<i>Caulerpa</i> sp.	2	30840.53***	2	49256.71***
Time	8	159.40	9	2009.51***
<i>Caulerpa</i> sp * time	16	777.92***	18	2896.16***
Residual	81	139.02	90	182.15

Table 3: Pearson bivariate correlations between caulerpenyne concentration in thallus parts with its biomass and temperature. ns means no significant correlations. * means significance 0.05, ** significance 0.01.

	Fronds		Stolons	
	Biomass	Temperature	Biomass	Temperature
<i>C. prolifera</i>	ns	ns	ns	ns
<i>C. taxifolia</i>	ns	0.644*	ns	ns
<i>C. racemosa</i>	ns	ns	ns	0.922**

Table 4: *Ascobulla fragilis* abundances in *Caulerpa prolifera* mats. In Feb 05, May 05 and Jun 05 faunal samples were not collected.

Date	<i>Ascobulla fragilis</i> (expressed as ind /m2)
Nov-04	408
Des-04	300
Jan-05	442
Mar-05	58
Apr-05	175
Jun-05	67
Aug-05	8

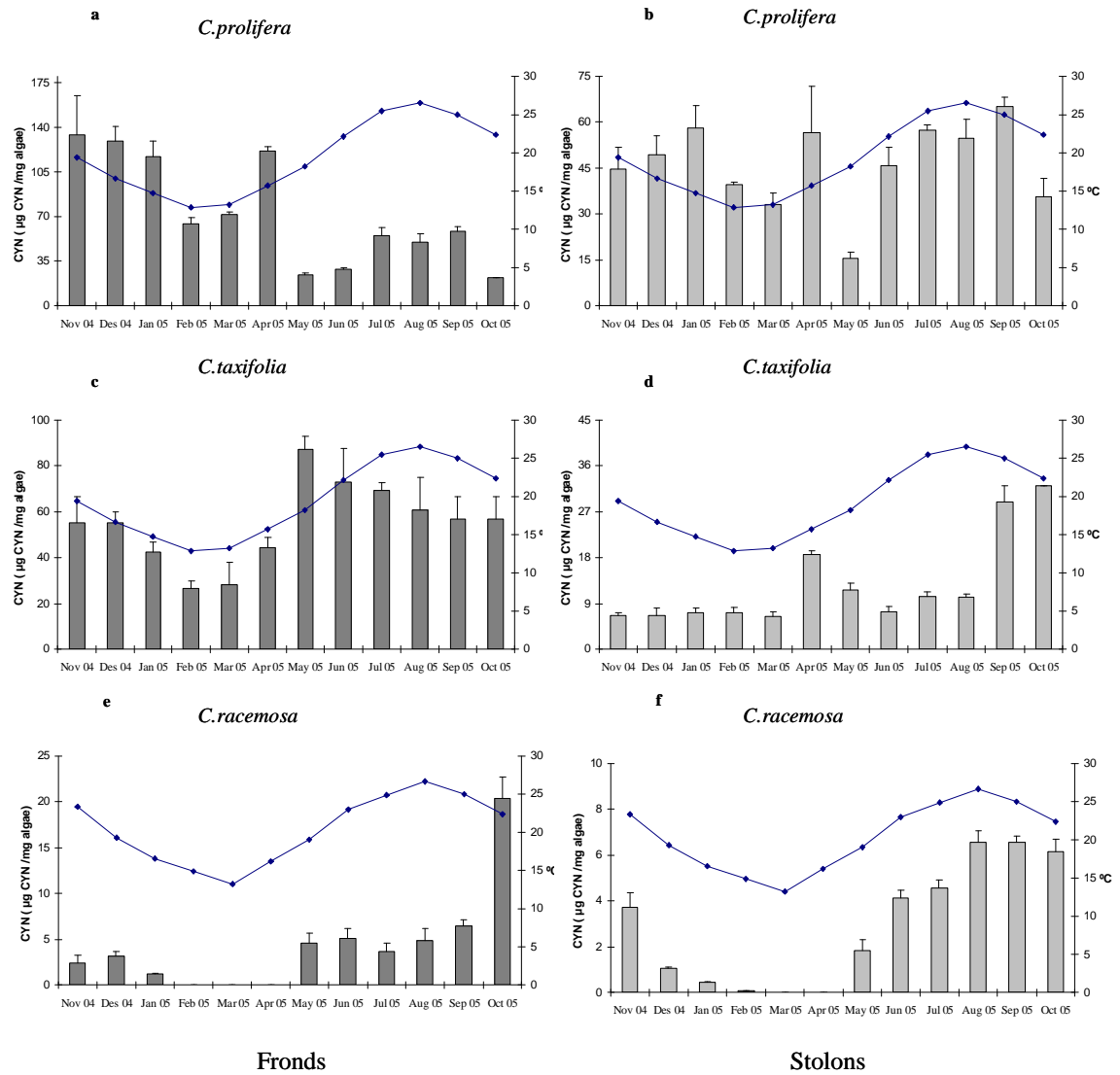

Figure 2: Concentration of caulerpenyne (CYN) in the fronds (left panels, a,c,e) and stolons (right panels, b, d, f) of three *Caulerpa* species in Mallorca (Western Mediterranean) from Novembre 2004 to October 2005. The solid line with triangles represents the temperature of sea water. The error bar represents ± 1 SE.

Ascobulla fragilis was the only *Caulerpa*-specialised opisthobranchia found in the three *Caulerpa* species. *A. fragilis* was more frequent and abundant in *C. prolifera* than in the non-native *Caulerpa*, where it was only found in one sampling date. The abundance of *A. fragilis* was higher from November to January than during the rest of the year (Table 4) and it was positively correlated ($Rho=0.837$ significance $p<0.05$) to the content of caulerpenyne in the fronds of *Caulerpa prolifera*.

The concentration of caulerpenyne in the stolons of *Caulerpa prolifera* was negatively correlated with that of *C. taxifolia* ($Rho=-0.364$ significance $p<0.05$) and *C. racemosa* ($Rho=-0.303$ significance $p<0.05$) and it was positively correlated between the last two species ($Rho=0.490$ significance $p<0.01$). The concentration of caulerpenyne in the fronds was not correlated between *Caulerpa* species.

Discussion

Our results demonstrate that the concentration of caulerpenyne differs significantly among *Caulerpa* species, and it decreases from *C. prolifera* to *C. taxifolia* and to *C. racemosa* var. *cylindracea*. The concentration of caulerpenyne was also different between fronds and stolons in *C. prolifera* and *C. taxifolia* but not in *C. racemosa* var. *cylindracea*. The stolons of *C. prolifera* have higher concentration of caulerpenyne than the stolons but in *C. taxifolia* the fronds have higher concentration of caulerpenyne than the stolons. Differences in the concentration of caulerpenyne among *Caulerpa* species had been previously reported by other authors (Paul and Hay 1986; Amade and Lemee 1998; Dumay et al. 2002; Jung et al. 2002; Sureda et al. 2006). The concentrations of caulerpenyne quantified in this study fall within the upper range of the concentrations of this compound reported for these *Caulerpa* species elsewhere (Table 5). In addition, and similar to previous studies (Amade and Lemee 1998; Dumay et al. 2002), we found that the concentration of caulerpenyne changes during the year.

Temperature and biomass seasonality were not the main factors that determine caulerpenyne concentrations in *C. prolifera* thallus parts. Both were not correlated with caulerpenyne concentration seasonal variations. High densities of *Ascobulla fragilis* were found in *C. prolifera*. *Ascobulla* is a specialized *Caulerpa* herbivore that uses caulerpenyne derivatives as chemical defence (Gavagnin et al. 1994; Marin and Ros 2004). *A. fragilis* mainly feeds over stolons (Sanchez-Moyano et al. 2004) which is the part of thallus with highest caulerpenyne concentration in *C. prolifera*. This fact could explain a higher protection in *C. prolifera* of stolons than fronds. Caulerpenyne concentration in stolons was positively correlated with the abundance of *A. fragilis*. Previous studies concluded that algae toxicity could be increased as result of herbivore pressure, which could drive an increase of concentration in the defensive metabolites in the algae (Vanalstyne 1988; Paul and Vanalstyne 1992; Erickson et al. 2006). Some small herbivores eat noxious plants to obtain relative safety against predators. In the Western Mediterranean, three ascoglossan species are known to feed on *C. prolifera*: *Lobiger serradifalci*, *Oxynoe olivacea* and *Ascobulla fragilis* (Barrajon et al. 2004; Sanchez-Moyano et al. 2004). Our results suggest that the presence of the opisthobranch *Ascobulla fragilis* could be a key factor explaining the high caulerpenyne concentrations in *C. prolifera* stolons.

Caulerpenyne concentration in *Caulerpa taxifolia* was 2-10 times higher in fronds than stolons depending on the period of the year. In *C. taxifolia* the highest caulerpenyne concentration was found in spring in fronds and in summer-autumn in stolons. The increase in caulerpenyne concentration during spring was observed earlier in stolons (April) than in fronds (May). These values corresponded to the minimum biomass period of fronds and stolons of *C. taxifolia* and appear just before *C. taxifolia* increased its biomass. *C. taxifolia* habitat colonisation in Balearic Islands is in a patchy distribution and does not form dense meadows, moreover, in winter, in the seagrass meadow only a few fronds and stolons remain over dead *P. oceanica* rhizomes. An increase in water temperature provides a better environment for the growth of *C. taxifolia*, which increases its biomass and protects the new structures with secondary metabolites. Caulerpenyne concentration in *C. taxifolia* stolons exhibited a different seasonal pattern, with an important increase at the end of summer. These results are similar to those obtained in previous studies (Amade and Lemee 1998; Dumay et al. 2002) which reported higher caulerpenyne concentration in summer and autumn but these studies were performed in monoespecific *Caulerpa* meadows which present high biomass values along the year. Caulerpenyne concentration in fronds was positively correlated with temperature; when temperature was over 18°C (May) a significant increase in caulerpenyne concentration occurred. Amade and Lemee (1998) found this important increase in caulerpenyne concentration in June with temperatures over 20 °C in samples obtained over a rocky substrate in Cap Martin, with high *C. taxifolia* winter biomass.

Caulerpa racemosa var. *cylindracea*, is the most recent *Caulerpa* species in the Balearic Islands waters (Ballesteros et al. 1999). Nowadays, *C. racemosa* var. *cylindracea* has colonised larger areas around Balearic Islands than *C. taxifolia* (Personal observations). In agreement with previous works (Dumay et al. 2002; Jung et al. 2002) *C. racemosa* var. *cylindracea* showed lower caulerpenyne concentration compared with the other two studied *Caulerpa* (Table 5). In the coldest period, from February to April, there was practically null *C. racemosa* var. *cylindracea* biomass and consequently no caulerpenyne concentration measurements could be performed. The influence of temperature on caulerpenyne concentration was observed in stolons with a positive correlation between them. The seasonality observed in caulerpenyne concentration was similar to that described by Dumay (2002) along one year cycle.

Caulerpenyne concentration did not present significant differences between fronds and stolons which suggest that both thallus parts are similarly protected against herbivores.

This study showed different seasonal variations of caulerpenyne for the three *Caulerpa* species inhabiting the Balearic Islands under similar seasonal and climate forcing. *Caulerpa prolifera* had inverse seasonal production of caulerpenyne in stolons compared to invasive *Caulerpa* species as Pearson's result shows. The invasive *Caulerpa* species caulerpenyne concentrations in stolons were positively correlated, confirming similar trend in the caulerpenyne concentrations for invasive species. The native Mediterranean *Caulerpa prolifera* species presents the highest caulerpenyne concentrations in stolons as a response to grazing pressure and direct herbivorism being more chemically protected than invasive *Caulerpa* species.

The invasive species *C. taxifolia* and *C. racemosa* had not associated an established community of *Caulerpa* specialized feeders which excludes the herbivorism as a factor affecting the concentration of caulerpenyne in the thallus parts of these species. In invasive *Caulerpa* species temperature was correlated with the concentration of caulerpenyne in fronds of *C. taxifolia* and stolons of *C. racemosa*. Previous studies have also shown the highest concentrations of caulerpenyne coincident with higher temperatures (Amade and Lemee 1998; Dumay et al. 2002). *C. taxifolia* fronds present higher caulerpenyne concentrations than stolons, while in *C. racemosa* similar concentration of caulerpenyne was found in fronds and stolons. Each invasive *Caulerpa* species shows the highest concentration of caulerpenyne in the thallus part where the highest proportion of biomass is recorded. Field results in *C. prolifera* did not reflect the seasonal cycle in temperature at our region of study and the presence of small *Caulerpa* herbivorous influence the caulerpenyne production.

In conclusion, under similar climate conditions and seasonality, *C. prolifera* is the *Caulerpa* species with higher caulerpenyne concentration in Balearic Islands followed by *C. taxifolia* and *C. racemosa* var. *cylindracea*. The expansion of invasive *Caulerpa* species does not seem to depend on the caulerpenyne concentration, higher in *C. prolifera* than in invasive *Caulerpa* species. Temperature is an important factor influencing the caulerpenyne concentration in invasive *Caulerpa* species but not in *C. prolifera*. However the concentration of caulerpenyne in *C. prolifera* stolons was correlated with the abundance of stolons specialised herbivore *Ascobulla fragilis*. This result suggests that the feeding activity of this herbivore influences the concentration of caulerpenyne. Therefore, further studies are needed to evaluate in different aspects of

the physiology and seasonality on the toxicity of *Caulerpa* macroalgae, on the biotic interactions with other plant species, on the effects of temperature and on the herbivorous pressure to discern the main factors involved in the caulerpenyne production.

Acknowledgements

The authors are grateful to Philip Amade for his technical assistance. This work was supported by the research projects “Expansión de *Caulerpa prolifera*, *C. taxifolia* y *C. racemosa* en el Mediterráneo: dinámica clonal, producción y destino de la producción” (REN2002-00701/MAR) and “Macroalgas marinas invasoras en las Islas Baleares: Evaluación de riesgos y efectos en comunidades bentónicas” (CTM2005-01434/MAR) of the Ministerio de Educación y Ciencia. A. Box was supported by an I3P FSE postgraduate fellowship awarded by Consejo Superior de Investigaciones Científicas. Marina de Cala D’Or (Cala D’Or, Santanyí, Mallorca) kindly made available its harbour facilities for executing this study. We are most grateful to Piluca Sariera for her help along the entire project.

References

- Amade P, Valls R, Bouaiacha R, Lemee R, Artaud J (1994) Methodes de dosage de la caulerpenyne produite par *Caulerpa taxifolia* First International Workshop on *Caulerpa taxifolia*, Nice.
- Amade P, Lemee R, (1998) Chemical defence of the Mediterranean alga *Caulerpa taxifolia*: variations in caulerpenyne production. *Aquat Toxicol* 43:287-300.
- Amico V, Oriente G, Piattelli M, Tringali C, Fattorusso E, Magno S, Mayol L, (1978) Caulerpenyne, an Unusual Sesquiterpenoid from Green-Alga *Caulerpa prolifera*. *Tetrahedron Lett* 3593-3596
- Argyrou M, Demetropoulos A, Hadjichristophorou M, (1999) Expansion of the macroalga *Caulerpa racemosa* and changes in softbottom macrofaunal assemblages in Moni Bay, Cyprus. *Oceanol Acta* 22:517-528
- Balata D, Piazzzi L, Cinelli F, (2004) A comparison among assemblages in areas invaded by *Caulerpa taxifolia* and *C. racemosa* on a subtidal Mediterranean rocky bottom. *Mar Ecol P.S.Z.N. I* 25:1-13
- Ballesteros E, Grau A M, Riera F, (1999) *Caulerpa racemosa* (Forsskal) J. Agardh (Caulerpales, Chlorophyta) in Mallorca (Western Mediterranean). *Boll Soc Hist Nat Illes Balears* 42:63-69
- Barbier P, Guise S, Huitorel P, Amade P, Pesando D, Briand C, Peyrot V., (2001) Caulerpenyne from *Caulerpa taxifolia* has an antiproliferative activity on tumor cell line SK-N-SH and modifies the microtubule network. *Life Sci* 70:415-429.
- Boudouresque C F, Meinesz A, Ribera M A, Ballesteros E, (1995) Spread of the green alga *Caulerpa taxifolia* (Caulerpales, Chlorophyta) in the Mediterranean: Possible consequences of a major ecological event. *Sci Mar* 59:21-29
- Boudouresque, C F, (1998) Follow up of biological introduction in the sea. *Biofutur* 76-78
- Boudouresque C F, Verlaque M, (2002) Biological pollution in the Mediterranean Sea: invasive versus introduced macrophytes. *Mar Pollut Bull* 44:32-38
- Buia M C, Gambi M C, Terlizzi A, Mazzella L, (2001) Colonization of *Caulerpa racemosa* along the southern italian coast: I.Distribution, phenological variability and ecological role. In: Gravez, V., Ruitton, S., Boudouresque, C.F., Le Direac'h,

- L., Meinesz, A.. Fourth International Workshop on *Caulerpa taxifolia*, vol. GIS Posidonie, France pp 352-360
- Ceccherelli G, Campo D, (2002) Different effects of *Caulerpa racemosa* on two co-occurring seagrasses in the Mediterranean. *Bot Mar* 45: 71-76
- Devillele X, Verlaque M, (1995) Changes and Degradation in a *Posidonia oceanica* Bed Invaded by the Introduced Tropical Alga *Caulerpa taxifolia* in the North-Western Mediterranean. *Bot Mar* 38:79-87
- Dumay O, Pergent G, Pergent-Martini C, Amade P, (2002) Variations in caulerpenyne contents in *Caulerpa taxifolia* and *Caulerpa racemosa*. *J Chem Ecol* 28:343-352
- Erickson AA, Paul V J, Van Alstyne K L, Kwiatkowski L M, (2006) Palatability of macroalgae that use different types of chemical defenses. *J Chem Ecol* 32, 1883-1895
- Galil B S, (2007) Loss or gain? Invasive aliens and biodiversity in the Mediterranean Sea. *Mar Pollut Bull* 55:314-322
- Gavagnin M, Marin A, Castelluccio F, Villani G, Cimino G, (1994). Defensive Relationships between *Caulerpa prolifera* and its Shelled Sacoglossan Predators. *J Exp Mar Biol Ecol* 175:197-210
- Guerriero A, Meinesz A, Dambrosio M, Pietra F, (1992) Isolation of Toxic and Potentially Toxic Sesquiterpenes and Monoterpenes from the Tropical Green Seaweed *Caulerpa taxifolia* Which Has Invaded the Region of Cap Martin and Monaco. *Helv Chim Acta* 75:689-695
- Hay M E, Fenical W, (1988) Marine Plant-Herbivore Interactions - the Ecology of Chemical Defense. *Annu Rev Ecol Syst* 19:111-145
- Jung V, Pohnert G, (2001) Rapid wound-activated transformation of the green algal defensive metabolite caulerpenyne. *Tetrahedron* 57:7169-7172
- Jung V, Thibaut T, Meinesz A, Pohnert G, (2002) Comparison of the wound-activated transformation of caulerpenyne by invasive and noninvasive *Caulerpa* species of the Mediterranean. *J Chem Ecol* 28:2091-2105
- Lemee R, Boudouresque C F, Gobert J, Malestroit P, Mari X, Meinesz A, Menager V, Ruitton S, (1996) Feeding behaviour of *Paracentrotus lividus* in the presence of *Caulerpa taxifolia* introduced in the Mediterranean Sea. *Oceanol Acta* 19:245-253
- Mack R N, Simberloff D, Lonsdale W M, Evans H, Clout M, Bazzaz, F A, (2000) Biotic invasions: Causes, epidemiology, global consequences, and control. *Ecol Appl* 10: 689-710

- Marin A, Ros J, (2004) Chemical defenses in Sacoglossan Opisthobranchs: Taxonomic trends and evolutive implications. *Sci Mar* 68:227-241.
- Meinesz A, (2004) *Caulerpa taxifolia* continues its invasion. *Biofutur* 41-46
- Meinesz A, Belsher T, Thibaut T, Antolic B, Mustapha K B, Boudouresque C F, Chiaverini D, Cinelli F, Cottalorda J M, Djellouli A S, El Abed A, Orestano C, Grau A M, Ivesa L, Vaugelas I, Zavodnik N, Zuljevic A, (2001). The introduced green alga *Caulerpa taxifolia* continues to spread in Mediterranean. *Biol Inv* 3: 201-210.
- Meinesz A, Devaugelas J, Hesse B, Mari X, (1993). Spread of the Introduced tropical green alga *Caulerpa taxifolia* in Northern Mediterranean Waters. *J Appl Phycol* 5: 141-147
- Meinesz A, Hesse B, (1991) Introduction of the Tropical Alga *Caulerpa taxifolia* and Its Invasion of the Northwestern Mediterranean. *Oceanol Acta* 14:415-426
- Meyer K D, Paul V J, (1992). Intraplant Variation in Secondary Metabolite Concentration in 3 Species of *Caulerpa* (Chlorophyta, Caulerpales) and Its Effects on Herbivorous Fishes. *Mar Ecol-Prog Ser* 82: 249-257
- ParentMassin D, Fournier V, Amade P, Lemee R, DurandClement M, Delescluse C, Pesando D, (1996) Evaluation of the toxicological risk to humans of caulerpenyne using human hematopoietic progenitors, melanocytes, and keratinocytes in culture. *J Tox Env Health* 47:47-59
- Paul V J, Fenical W, (1986a) Chemical Defense in Tropical Green-Algae, Order Caulerpales. *Mar Ecol-Prog Ser* 34:157-169
- Paul V J, Hay M E, (1986b) Seaweed Susceptibility to Herbivory - Chemical and Morphological Correlates. *Mar Ecol-Prog Ser* 33:255-264
- Paul V J, Vanalstyne K L, (1992) Activation of Chemical Defenses in the Tropical Green-Algae *Halimeda* Spp. *J Exp Mar Biol Ecol* 160:191-203.
- Pesando D, Lemee R, Ferrua C, Amade P, Girard J P, (1996) Effects of caulerpenyne, the major toxin from *Caulerpa taxifolia* on mechanisms related to sea urchin egg cleavage. *Aquat Toxicol* 35:139-155
- Piazzzi L, Balata D, Ceccherelli G, Cinelli F, (2001) Comparative study of the growth of the two co-occurring introduced green algae *Caulerpa taxifolia* and *Caulerpa racemosa* along the Tuscan coast (Italy, western Mediterranean). *Cryptogamie Algol* 22:459-466

- Pohnert G, Jung V, (2003) Intracellular compartmentation in the biosynthesis of caulerpenyne: Study on intact macroalgae using stable-isotope-labeled precursors. *Org Lett* 5:5091-5093.
- Sakai A K, Allendorf F W, Holt J S, Lodge D M, Molofsky J, With K A, Baughman S, Cabin R J, Cohen J E, Ellstrand N C, McCauley D E, O'Neil P, Parker I M, Thompson J N, Weller S G, (2001). The population biology of invasive species. *Annu Rev Ecol Syst* 32:305-332
- Sanchez-Moyano J E, Moreno D, Rueda J L, Garcia-Raso J E, Salas C, Gofas S, (2004) Las praderas de *Caulerpa prolifera*. In: Luque Á A and Templado J (Eds), Praderas y bosques marinos de Andalucía. Junta de Andalucía, Sevilla, pp 239-249
- Sureda A, Box A, Ensenat M, Alou E, Tauler P, Deudero S, Pons A, (2006) Enzymatic antioxidant response of a labrid fish (*Coris julis*) liver to environmental caulerpenyne. *Comp Biochem Physiol* 144C, 191-196
- Vanalstyne K L, (1988). Herbivore Grazing Increases Polyphenolic Defenses in the Intertidal Brown Alga *Fucus distichus*. *Ecology* 69:655-663
- Verlaque M, Afonso-Carrillo J, Gil-Rodríguez M C, Durand C, Boudouresque C F, Le Parco Y, (2004) Blitzkrieg in a marine invasion: *Caulerpa racemosa* var. *cylindracea* (Bryopsidales, Chlorophyta) reaches the Canary Islands (north-east Atlantic). *Biol Inv* 6: 269-281.
- Verlaque M, Boudouresque C F, Meinesz A, Gravez V, (2000) The *Caulerpa racemosa* complex (Caulerpales, Ulvophyceae) in the Mediterranean Sea. *Bot Mar* 43:49-68
- Verlaque M, Durand C, Huisman J M, Boudouresque C F, Le Parco Y, (2003) On the identity and origin of the Mediterranean invasive *Caulerpa racemosa* (Caulerpales, Chlorophyta). *Eur J Phycol* 38:325-339
- Verlaque M, Fritayre P, (1994) Mediterranean algal communities are changing in the face of the invasive alga *Caulerpa taxifolia* (Vahl). *Oceanol Acta* 17:659-672.

6.3 Enzymatic antioxidant response of a labrid fish (*Coris julis*) liver to environmental caulerpenyne

Abstract

Exposure of marine animals to certain toxic compounds can enhance reactive oxygen species production with subsequent damage to macromolecules and alterations in oxidant defenses levels. Caulerpenyne is the major metabolite synthesized by *Caulerpa* species, used as chemical defense affecting several cellular and molecular targets. We assessed the changes produced by the presence of *Caulerpa* spp. in the activities of antioxidant enzymes as well as lipid peroxidation levels in liver of *Coris julis*. Fishes were captured at two stations with *Caulerpa* species -*Caulerpa taxifolia* and *Caulerpa prolifera*- and at a region with the seagrass *Posidonia oceanica* as negative control. Caulerpenyne concentration was significantly higher in *Caulerpa prolifera* than in *Caulerpa taxifolia* ($p < 0.05$). Glutathione S-transferase, glutathione peroxidase and glutathione reductase activities were significantly higher in both *Caulerpa* stations compared to the *Posidonia oceanica* ($p < 0.05$). No statistical difference ($p > 0.05$) existed in Catalase activity between groups. Glutathione reductase activity is significantly higher in *Caulerpa prolifera* station than in *Caulerpa taxifolia* ($p < 0.05$). Despite the variations in the antioxidant enzyme activities, there was no significant difference in malondialdehyde concentration. In conclusion, the production of caulerpenyne by *Caulerpa* species could induce an antioxidant adaptation in the liver of *Coris julis* in order to prevent oxidative damage.

Keywords: Antioxidant enzymes, Oxidative stress, *Caulerpa*, *Coris julis*, Caulerpenyne, Catalase, Glutathione peroxidase, Glutathione S-transferase, Lipid peroxidation.

Introduction

The seaweed of tropical origin algae *Caulerpa taxifolia* (Vahl) C. Agardh was introduced in the Mediterranean Sea in 1984 (Meinesz and Hesse 1991). In a decade, *C. taxifolia* had spread along the western Mediterranean Sea colonizing over a variety of substrates in a wide depth range (Meinesz et al. 1993; Meinesz 2004), covering the infralittoral zone and competing with autochthonous flora (Verlaque and Fritayre 1994). *C. taxifolia* induces an homogenation of microhabitats provided to fishes resulting in a persistent decrease in mean species richness, density and biomass, when compared to indigenous communities living in *Posidonia oceanica* beds or in rocky areas (BellanSantini et al. 1996; Arigoni et al. 2002).

The green algae *Caulerpa prolifera* (Forsskal) Lamouroux is a subtropical algae with a growth-reproductive cycle water temperature dependent (Meinesz 1979). It is found along all Mediterranean Sea and is considered autochthonous specie.

Caulerpales produce repulsive and toxic secondary metabolites against grazers and fouling organisms (Doty 1966; Maiti et al. 1978; Mahendran et al. 1979; Nielsen et al. 1982; Schwede et al. 1987; Jung et al. 2002). Caulerpenyne (CYN) is the main secondary metabolite synthesized by the *Caulerpa* green marine algae family (Ulvophyceae, Caulerpales), playing a major role in its chemical defense (Pohnert and Jung 2003). CYN has antibiotic properties and cytotoxic effects in mammalian cells (ParentMassin et al. 1996; Barbier et al. 2001). In animals, exogenous molecules should be rapidly metabolised and/or excreted in order to avoid its accumulation in the body. This metabolism, which inactivates toxic compounds, is mainly produced in the liver. There is a direct evidence that *Oxynoe olivacea*, a Mediterranean sacoglossan, transforms efficiently the algal metabolite CYN into oxytoxin-2, the main defensive metabolite of the mollusc (Cutignano et al. 2004). Patients with food poisoning due to the ingestion of *Sarpa salpa*, a fish consuming *C. taxifolia*, showed neurological disorders such as amnesia, vertigo, and hallucinations; these symptoms have been associated to CYN (De Haro et al., 1993).

Cellular oxidative metabolism is a continuous source of reactive oxygen species (ROS), resulting from univalent reduction of O₂, which can damage most cellular components. Cells contain a complex network of antioxidant defense that scavenge or prevent the generation of ROS, and repair or remove the damaged molecules (Elias et

al. 1999). The antioxidant system involves enzymes such as superoxide dismutases (SOD), catalase (CAT), glutathione peroxidase (GPx) and glutathione reductase (GR) that act by detoxifying the ROS generated. Moreover, in animal liver, glutathione S-transferase (GST) produces a glutathione conjugate that seems to be the first step in the detoxification of several toxins. This enzyme also plays a role in protection against oxidative stress by catalysing a selenium-independent glutathione-peroxidase activity (Prohaska, 1980). The conversion of several toxins to a more polar compound is correlated with a depletion of the cellular glutathione pool (Kondo et al. 1996; Pffugmacher et al. 1998). Thus, the GST activity has been used as marker of detoxification in aquatic organisms and as biomarker of water pollution (Di Giulio et al. 1993; Gravato et al. 2005). Nevertheless, under several situations, the rate of generation of ROS exceeds that of their removal, inducing oxidative stress and increasing oxidative markers. It is well established that pollutants such as various pesticides (Sayeed et al., 2003) and metals (Almeida et al., 2002), as well as, hyperoxia exposure (Lushchak and Bagnyukova, 2006) stimulate protective mechanisms against ROS. Naturally occurring toxicans such as microcystins, a family of cyclic peptide toxins produced by cyanobacteria, are also capable of inducing oxidative stress (Jos et al., 2005).

Fish are of special interest to study oxidative stress because of the properties of the water environment and its relationship with organisms. The *Caulerpa taxifolia* meadows seem to be a favorable environment for the recruitment of the labridae fish *Coris julis* (Linnaeus, 1758) (Francour et al. 1995). Dispersion is apparently limited in *C. julis*, given that it shows sedentary habits and that migration movements have not been described to date in this species (Michel et al., 1987). An adaptative coloration is detected in *C. julis* living in *C. taxifolia* towards an increase in green coloration of the fishes (Arigoni et al. 2002). The diet of *C. julis* is based on zoobenthos such as molluscs and benthic crustaceans (Pinnegar and Polunin 2000). *C. julis* living in *Caulerpa* spp. meadows are in direct contact with CYN not only from food sources, but also directly from *C. taxifolia* meadows which produce CYN (Amade et al. 1998).

Contaminants in exposed organisms increase the production of ROS leading to oxidative damage (Livinstone 2001). Changes in the levels of endogenous antioxidant defenses have been proposed as biomarkers of aquatic pollution (Livinstone 2001; Camus et al. 2004). In this work we studied the antioxidant enzyme response and the existence of cellular oxidative damage in liver of *C. julis* exerted by the different CYN

content of two *Caulerpa* species –*C. taxifolia* and *C. prolifera*– and the seagrass *P. oceanica*, used as negative control.

Materials and methods

***Coris julis* sampling**

All *C. julis* fishes were sampled in September and October 2004 at Mallorca Island (Balearic Islands, Spain). Three sampling stations were selected (Fig. 1). The first station was located in Cala d'Or and was invaded by *C. taxifolia*. The second station was located in Cala Llonga, with a meadow of *C. prolifera*. The control station was located near Portals Vells, in a *P. oceanica* meadow with no presence of *Caulerpa* spp. Depth at the three stations was about 5-7 meters.

Caulerpenyne assay

Caulerpenyne (CYN) contents were measured in fronds and stolons of *C. taxifolia* and *C. prolifera* manually collected by scuba diving. *Caulerpa* samples were collected carefully to prevent the alga fragmentation avoiding the transformation of CYN into reactive aldehydes and, transported in marine fresh water until processing to prevent CYN degradation before extraction. The samples were quickly washed in fresh water to remove salt and dried with absorbent paper. Then, 5 g were placed in 50 ml of methanol to obtain the crude methanolic extracts. This CYN extraction was performed within one hour from collection. The extracts were filtered on silica columns. Each sample was eluted with 5 ml of a mixture of methanol:ethyl acetate 50:50. CYN concentration was determined using a HPLC method. The mobile phase consisted of 80:20 methanol:H₂O. The HPLC was a Shimadzu with a diode array detector and the column was a Nova Pak, C18, 3.9 x 150 mm. CYN was determined at 254 nm and was quantified by comparison to a standard curve of known concentration. Pure CYN to establish an standard curve was provided by Dr. Amade P. (Equipe Antitumoraux Naturels, Universite Nice, Sophie Antipolis).

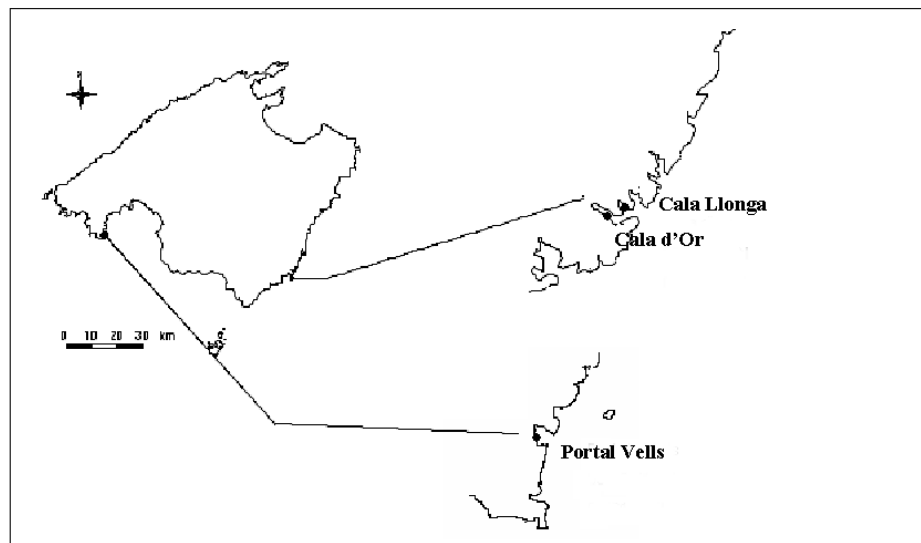

Fig 1: Distribution of the Sampling locations in Majorca Island (Balearic Islands, Spain). In the Bahía of Cala d'Or were placed Cala Llonga station (*C. prolifera*) and Cala d'Or station (*C. taxifolia*). The control station was placed in Portals Vells (*P. oceanica*).

Experimental animals

Coris julis were chosen because of its wide geographical distribution and great abundance in the Balearic region. The size of the fish (total length:10-14 cm) caught in the three stations was similar and corresponded to adult female individuals. Specimens were caught alive by fishing, and immediately killed by decapitation. Liver was immediately removed, washed carefully with 0.9% NaCl to prevent enzyme activities from blood and frozen in liquid nitrogen. 10 individuals were sampled in each station.

Preparation of liver homogenates

Livers were homogenized in ten volumes (w/v) of 100 mM Tris-HCl buffer pH 7.5. Homogenates were centrifuged at 9,000 g, 10 min, 4°C. Antioxidant enzyme activities –CAT, GPx, GR and GST- and MDA concentration were determined on the supernatants. All results were referred to the protein content in the samples (Biorad Protein Assay).

Enzymatic activities

All enzyme activities were determined with a Shimadzu UV-2100 spectrophotometer at 37°C. GST activity was measured by the method of Habig (Habig et al. 1974) using reduced glutathione (GSH) and 1-chloro-2,4-dinitrobenzene (CDNB) as substrates. CAT activity was measured by the spectrophotometric method of Aebi (Aebi 1984) based on the decomposition of H₂O₂ in 50 mM phosphate buffer. GPx activity was measured using an adaptation of the spectrophotometric method of Flohé and Gunzler (Flohe and Gunzler 1984). This activity was determined with hydrogen peroxide (H₂O₂) and GSH as substrates and GR and NADPH as enzyme and non-enzymatic indicators, respectively. GR activity was measured by a modification of the Goldberg and Spooner method (Goldberg and Spooner 1984), which required oxidized glutathione (GSSG) as substrate.

MDA determination

Malondialdehyde (MDA), as a marker of lipid peroxidation, was analyzed by a colorimetric assay kit (Calbiochem, San Diego, CA, USA) following the manufacturer's instructions. Briefly, liver homogenates or standard were placed in a glass tubes containing n-methyl-2-phenylindole (10.3 mM) in acetonitril:methanol (3:1). HCl 12 N was added and samples were incubated one hour at 45 °C. The absorbance was measured at 586 nm. MDA concentration was calculated using standard curve of known concentration.

Statistical Analysis

Statistical analysis was carried out using a statistical package (SPSS 12.0 for Windows[®]). The statistical significance of the antioxidant enzyme activities was compared by one-way analysis of variance (ANOVA). The statistical significance of CYN concentration was assessed by two-way ANOVA. The statistical factors analyzed were *Caulerpa* specie (C) and the parts of the algae analysed (P). Least significant difference t-test (LSD) post hoc paired comparison was further made to recognize

deviant groups. Results are expressed as mean +/- S.E.M. and $P < 0.05$ was considered statistically significant.

Results

C. julis showed a higher proportion of green morphs in both the *C. taxifolia* and *C. prolifera* meadows, compared to *P. oceanica* beds. In the *P. oceanica* seagrass bed, a great abundance of brown-white morph was observed.

We compared the CYN content in the two *Caulerpa* species selected and in *P. oceanica*, as negative control. The CYN content was significantly higher in fronds than in stolons in both *Caulerpa* species (Fig 2). The concentration of CYN in the seagrass *P. oceanica* was null (data not shown). CYN concentration presented significant differences between the algae *C. prolifera* and *C. taxifolia*. In *C. prolifera*, our results showed a significant higher CYN concentration, in both fronds and stolons, than in *C. taxifolia*.

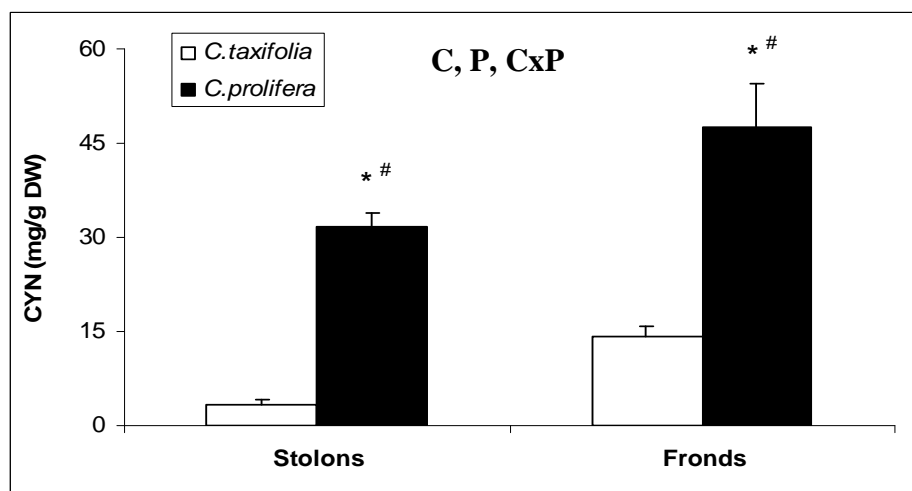

Fig 2: CYN concentration in stolons and fronds from the two *Caulerpa* species. There was no presence of CYN in *P. oceanica*. Values were computed as means±S.E.M. Significant effects of *Caulerpa* specie (C) and the parts of the algae analysed (P) or interaction of both factors (CxP). Two-way ANOVA. (*) Indicates significant differences between *C. taxifolia* and *C. prolifera*. (#) Indicates significant differences between fronds and stolons, $p < 0.05$.

The hepatic antioxidant enzyme activities of *C. julis* living in the two *Caulerpa* stations with environmental CYN and in the *Posidonia* station without CYN are reported in Table 1. We measured the antioxidant enzyme activities –CAT, GPx, GR

and GST- in the liver of *C. julis*, as markers of oxidative stress. CAT presented similar activities in the three regions studied. GPx activity was higher in the two stations with *Caulerpa* respect to *Posidonia* (*C. prolifera*, 38%; *C. taxifolia*, 27%). GR activity was higher in both *C. prolifera* and *C. taxifolia* stations compared to *Posidonia* (*C. prolifera*, 180%; *C. taxifolia*, 76%). GR activity measured in *C. julis* liver was significantly higher in the *C. prolifera* station than in the *C. taxifolia* one (60%). GST activity in liver of *C. julis* was significantly higher (about 65%) in both *Caulerpa* stations compared to the *Posidonia* station, with no significant differences between the two *Caulerpa* stations.

Table 1:Antioxidant enzyme activities in the liver of *Coris julis*. One-way ANOVA. (*) Indicates significant differences respect to *Posidonia oceanica*. (#) Indicates significant differences respect to *C. taxifolia*, p<0.05

	<i>P. oceanica</i>	<i>C. taxifolia</i>	<i>C. prolifera</i>
CAT			
K/mg prot	53.2 ± 6.1	54.9 ± 4.3	57.3 ± 4.9
GPx			
nKat/mg prot	11.3 ± 1.1	14,4 ± 0.9 *	15.7 ± 1.6 *
GR			
nKat/mg prot	18.0 ± 2.4	31.7 ± 3.3 *	50.5 ± 7.4 *,#
GST			
nKat/mg prot	232 ± 24	371 ± 34 *	391 ± 28 *

MDA concentration was used to evaluate the lipid peroxidative status in liver of CYN exposed and control *C. julis* (Figure 3). Hepatic MDA levels showed no significant differences between the three areas.

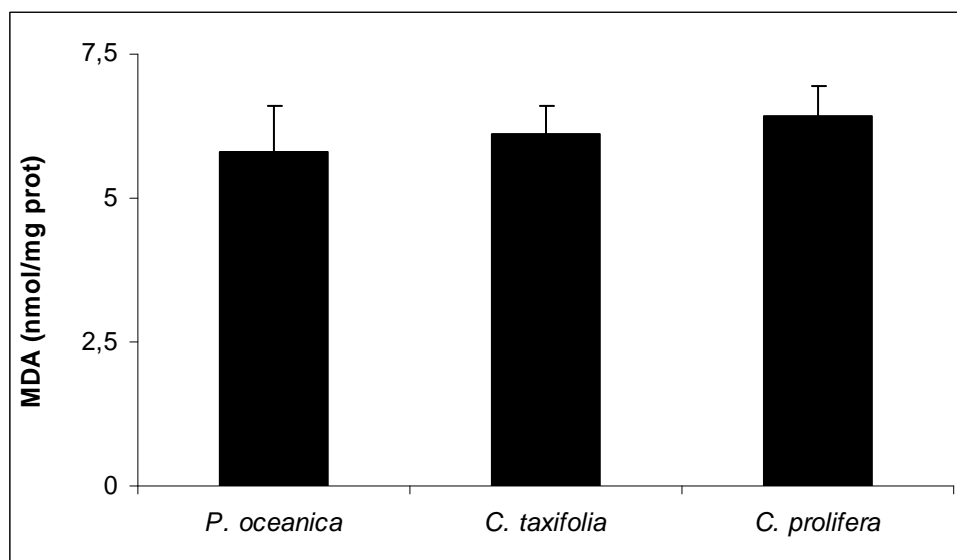

Fig 3: MDA concentration in the liver of *Coris julis*. Values were computed as means \pm S.E.M. One-way ANOVA. No significant differences were observed between stations, $p>0.05$.

Discussion

Oxidative stress is related to the formation of ROS, which are continuously generated endogenously as a result of normal metabolism. Furthermore, ROS can be generated as by-products of biotransformation reactions of toxins or xenobiotics. Cellular antioxidant systems have demonstrated a great adaptation to oxidative stress in order to counteract the excessive ROS production (Alvarez and Boveris 1993; Niwa et al. 1996). ROS may also act as messenger molecules to activate adaptive responses through redox-sensitive signalling pathways to maintain cellular oxidant-antioxidant homeostasis. Activation of NF-kappaB signalling pathway has been shown to elevate the gene expression of antioxidant enzymes (Ji et al., 2006). Cellular antioxidant status is used to evaluate the ability of organisms to resist an environmental stress such as some marine pollutants (Frenzilli et al. 2004). Correlations between the efficiency of ROS detoxification and the stress tolerance were reported by several authors (Porte et al. 2002; Cavas and Yurdakoc 2005a). However, biological responses of environmentally exposed animals are often barely interpretable because of the high complexity of the pollutants and also because chronic exposure to low levels of contaminants can lead to physiological mechanisms of adaptation reducing the animal sensitivity to contaminants.

CYN secreted by the members of genus *Caulerpa* presents toxic effects evidenced on various species (ParentMassin et al. 1996; Brunelli et al. 2000; Barbier et al. 2001; Mozzachiodi et al. 2001). The present study shows the first evidence correlating the presence of CYN with a higher antioxidant activity in the species living in caulerpa meadows. Previous results of the genus *Caulerpa* in the Mediterranean showed a higher concentration of CYN in *C. taxifolia* respect to *C. prolifera* (Amico et al. 1978; Gavagnin et al. 1994; Amade and Lemee 1998). Our results showed a higher presence of CYN in the *C. prolifera* meadow compared to *C. taxifolia*. The presence of CYN in *C. prolifera* and *C. taxifolia* meadows could induce an antioxidant response as we evidenced with the higher antioxidant enzyme activities as GPx and GR in the liver of *C. julis*. The presence of *C. julis* in *C. prolifera* meadows, with the higher CYN levels indicates that the fish is well adapted to the presence of the toxin, with the antioxidant defences participating in the adaptation mechanism.

CYN degradation is very fast with a total disappearance within 24 hours, but the continuous production of CYN by *caulerpa* spp. suggests that the presence of CYN is high at the surface of the algae with a negative gradient in the immediate seawater environment (Amade and Lemee 1998). *C. julis* is a benthic fish that lives inside Caulerpa meadows, so is directly affected by the CYN presence in the seawater. It has been evidenced that changes in color morphs occurred relatively slowly, probably involving acquisition or loss of pigments (Arigoni et al. 2002). The different coloration observed in *C. julis* suggest that this fish does not easily change its location. The diet of *C. julis* is based on the benthic invertebrates living in the meadow. Some of the benthic invertebrates (*Lobiger serradifalci*, *Oxynoe olivacea*, *Bittium reticulatum*, *Rissoa* sp. or others) eat *Caulerpa* spp. accumulating and/or metabolising CYN to other compounds. These sea slugs transform CYN to more toxic structures such as oxytoxin-1 and -2 which are known as ichthyotoxic substances (Thibaut et al. 2001; Cutignano et al. 2004). Therefore the labridae *C. julis* would be directly affected not only by the variations of CYN concentration but also by other toxins by eating these sea slugs. Moreover, recent evidences prove that the invasive *C. taxifolia* as well as the non-invasive *C. prolifera* have the ability to transform CYN into reactive aldehydes, which could interact the *C. julis* liver (Jung et al. 2002).

The metabolism of toxic compounds results in the formation of ROS frequently, which contributes to their toxicity (Chovanec et al. 2003). It has been evidenced that microcystins produced by cyanobacterial cells induce oxidative stress in a time-

dependent manner evidenced by the induction of lipid peroxidation and by the increase in antioxidant enzymatic activities (Jos et al., 2005; Towner et al., 2002). GPx and CAT are the most important enzymes detoxifying H₂O₂, whereas SOD dismutates superoxide anion to H₂O₂. GPx, as well as GST, also participate in the detoxification of lipid hydroperoxides using GSH and, consequently, can reduce the cellular pool of GSH (Winston and Di Giulio 1991). In the present study we show an increased liver antioxidant defenses in *Caulerpa* meadows suggesting a possible interaction between CYN and antioxidant mechanisms.

In a previous study, it was evidenced that the enzymatic detoxifying system of Scorpio fish (*Scorpaena porcus*) was affected by the presence of *C. taxifolia* in its aquarium (Uchimura et al., 1999). The characteristics of CYN and particularly the presence of an acetylenic triple bond suggest that CYN could be a substrate of cytochrome P450 leading to the formation of reactive intermediates (Uchimura et al., 1999). The resulting reactive intermediates could induce lipid peroxidation that could be responsible for the enhanced GPX and GST activities.

The higher GPX and GST activities in the liver of *C. julis* observed in the stations with *Caulerpa* could be attributed to an enhanced biotransformation rate of CYN or repair of cellular components damaged by ROS, such as oxidized proteins. The GST activity requires GSH as a substrate, which is oxidized to GSSG. GSH is the most abundant cellular thiol and is involved in many metabolic processes (DeLeve and Kaplowitz 1991). Furthermore, GSH plays a central role in the detoxification of ROS, which can be generated as by-products during the biotransformation of a variety of endogenous and exogenous substances (Pastore et al. 2003). The maintenance of the GSH/GSSG ratio, which is used as marker of the cellular redox status, is essential for the normal cell metabolism. GR is the main system maintaining this ratio. GR catalyzes the reduction of GSSG to GSH in a NADPH-dependent reaction and therefore protects cells against oxidative damage (Jos et al. 2005). The high activity of GR in the *C. julis* liver reflects a high GSSG reduction in order to recycle GSH in the reduced form. The increased GPx and GST activities and the maintenance of CAT activity in *Caulerpa* stations could indicate a higher lipid hydroperoxide detoxification rather than H₂O₂ detoxification. These high activities evidenced in the *Caulerpa* stations could contribute in decreasing the GSH content in cells, and in parallel, in increasing GR activity. The higher antioxidant enzyme activities in the stations with *Caulerpa* could also be related to the lack of differences in MDA levels between the three stations analyzed. The

absence of an increased lipid peroxidation rate indicates that the antioxidant response of *C. julis* in the regions with *Caulerpa* is enough to counteract the increased oxidative stress induced by the presence of CYN.

In conclusion, the increased activity of liver antioxidant enzymes in *Caulerpa* stations is indirectly indicating the formation of ROS as well as ongoing detoxification of CYN. Activation of the antioxidant enzymatic system suggests that the defense system plays an important role in the response to an increased oxidative situation. The determination of antioxidant enzyme activities in fish livers allows detecting the presence of pollutants and toxins, such as CYN, in the meadows.

Acknowledgements:

The authors are grateful to Philip Amade for his technical assistance. A. Box was supported by a program IP3 fellowship (CSIC) This work was supported by the project “Expansión de *Caulerpa prolifera*, *C. taxifolia* y *C. racemosa* en el Mediterráneo: dinámica clonal, producción y destino de la producción” REN2002-00701 / MAR.

References

- Aebi, H.E., 1984. Catalase. In: Bergmeyer, H.U. (Ed.), *Methods in Enzymatic Analysis*. Verlag Chemie, Basel, pp. 273-286.
- Almeida, J. A., Diniz, Y. S., Marques, S. F. G., Faine, L. A., Ribas, B. O., Burneiko, R. C., Novelli, E. L. B., 2002. The use of the oxidative stress responses as biomarkers in Nile tilapia (*Oreochromis niloticus*) exposed to in vivo cadmium contamination. *Environ. Int.* 27, 673-679.
- Alvarez, S., Boveris, A., 1993. Induction of antioxidant enzymes and DT-diaphorase in human blood mononuclear cells by light stress. *Arch. Biochem. Biophys.* 305, 247-51.
- Amade, P., Joncheray, L., Brocque, S., Pesando, D., 1998. In: Boudouresque, C.F., Gravez, V., Meinesz, A. and Palluy, F., (Eds.), *Third International Workshop on Caulerpa taxifolia*. GIS Posidonie publication, pp. 133-142.
- Amade, P., Lemee, R., 1998. Chemical defence of the Mediterranean alga *Caulerpa taxifolia*: variations in caulerpenyne production. *Aquat. Toxicol.* 43, 287-300.
- Amico, V., Oriente, G., Piattelli, M., Tringali, C., Fattorusso, E., Magno, S., Mayol, L., 1978. Caulerpenyne, an unusual sesquiterpenoid from green alga *Caulerpa prolifera*. *Tetrahedron Letters*. 3593-3596.
- Arigoni, S., Francour, P., Harmelin-Vivien, M., Zaninetti, L., 2002. Adaptive colouration of Mediterranean labrid fishes to the new habitat provided by the introduced tropical alga *Caulerpa taxifolia*. *J. Fish Biol.* 60, 1486-1497.
- Barbier, P., Guise, S., Huitorel, P., Amade, P., Pesando, D., Briand, C., Peyrot, V., 2001. Caulerpenyne from *Caulerpa taxifolia* has an antiproliferative activity on tumor cell line SK-N-SH and modifies the microtubule network. *Life Sciences*. 70, 415-429.
- Brunelli, M., Garcia-Gil, M., Mozzachiodi, R., Roberto, M., Scuri, R., Traina, G., Zaccardi, M. L., 2000. Neurotoxic effects of caulerpenyne. *Progress in Neuro-Psychopharmacology & Biological Psychiatry*. 24, 939-954.
- Camus, L., Pampanin, D.M., Volpato, E., Delaney, E., Sanni, S., Nasci, C., 2004. Total oxyradical scavenging capacity responses in *Mytilus galloprovincialis* transplanted into the Venice lagoon (Italy) to measure the biological impact of anthropogenic activities. *Mar. Pollut. Bull.* 49, 801-808.

- Cavagnin, M., Marin, A., Castelluccio, F., Villani, G., Cimino, G., 1994. Defensive relationships between *Caulerpa prolifera* and its shelled sacoglossan predators. J. Exp. Mar. Biol. Ecol. 175, 197-210.
- Cavas, L., Yurdakoc, K., 2005. A comparative study: Assessment of the antioxidant system in the invasive green alga *Caulerpa racemosa* and some macrophytes from the Mediterranean. J. Exp. Marine Biol. Ecol. 321, 35-41.
- Cavas, L., Yurdakoc, K., Yokes, B., 2005. Antioxidant status of *Lobiger serradifalci* and *Oxynoe olivacea* (Opisthobranchia, Mollusca). J. Exp. Marine Biol. Ecol. 314, 227-235.
- Cazenave, J., Bistoni, M.A., Pesce, S.F., Wunderlin, D.A., 2006. Differential detoxification and antioxidant response in diverse organs of *Corydoras paleatus* experimentally exposed to microcystin-RR. Aquat. Toxicol. 5, 1-12.
- Chovanec, A., Hofer, R., Schiemer, F., 2003. Fish as bioindicators. In: Markert, B. A., Breure, A. M., Zechmeister, H. G., (Eds.), Bioindicators and Biomonitors. Elsevier Science, Amsterdam.
- Cutignano, A., Notti, V., d'Ippolito, G., Coll, A.D., Cimino, G., Fontana, A., 2004. Lipase-mediated production of defensive toxins in the marine mollusc *Oxynoe olivacea*. Organic Biomol. Chem. 2, 3167-3171.
- DeHaro, L., Treffot, M. J., Jouglard, J., Perringue, C., 1993. Trois cas d'intoxication de type ciguateresque après ingestion de sparidae de Méditerranée. Ichtyol. Physiol. Acta. 16,133-146.
- DeLeve, L.D., Kaplowitz, N., 1991. Glutathione metabolism and its role in hepatotoxicity. Pharmacol. Ther. 52, 287-305.
- Di Giulio, R.T., Habig, C., Gallagher, E.P., 1993. Effects of black rock harbour sediments on indices of biotransformation, oxidative stress and DNA integrity in channel catfish. Aquat. toxicol. 26, 1-22.
- Doty, M.S., 1966. Caulerpicin a Toxic Constituent of *Caulerpa*. Nature. 211, 990-&.
- Elias, S.J., Arner, E.S., Zhong, L., Holmgren, A., 1999. In: Packer, L., (ed) Methods in Enzymatic Analysis. Oxidants and Antioxidants. Academic Press, California vol. 300, pp 226-239.
- Flohe, L., Gunzler, W.A., 1984. Assays of glutathione peroxidase. Methods Enzymol 105, 114-21.

- Francour, P., Harmelinvivien, M., Harmelin, J.G., Duclerc, J., 1995. Impact of *Caulerpa taxifolia* colonization on the littoral ichthyofauna of North Western Mediterranean Sea - preliminary results. *Hydrobiologia*. 301, 345-353.
- Frenzilli, G., Bocchetti, R., Pagliarecci, M., Nigro, M., Annarumma, F., Scarcelli, V., Fattorini, D., Regoli, F., 2004. Time-course evaluation of ROS- mediated toxicity in mussels, *Mytilus Galloprovincialis*, during a field translocation experiment. *Mar. Environ. Res.* 58, 609-613.
- Gavagnin, M., Marin, A., Castelluccio, F., Villani, G., Cimino, G., 1994. Defensive relationships between *Caulerpa prolifera* and its shelled sacoglossan predators. *J. Exp. Marine Biol. Ecol.* 175, 197-210.
- Goldberg, D.M., Spooner, R.J., 1984. Glutathione reductase. In: Bergmeyer, H.U. (Ed.), *Methods in Enzymatic Analysis*. Verlag Chemie, Basel, pp. 258-265.
- Gravato, C., Oliveire, M., Santos, M.A., 2005. Oxidative stress and genotoxic responses to resin acids in Mediterranean mussels. *Ecotoxicol. Environ. Safety.* 61, 221-229.
- Habig, W.H., Pabst, M.J., Jokoby, W.B., 1974. Glutathione S-transferase. The first enzymatic step in mercapturic acid formation. *J. Biol. Chem.* 249, 7130-7139.
- Harmelin-Vivien, M., Francour, P., Harmelin, J.G., 1999. Impact of *Caulerpa taxifolia* on Mediterranean fish assemblages: a six year study. In *Proceedings of the Workshop on Invasive Caulerpa in the Mediterranean*. MAP technical Reports Series. UNEP, Athens, pp. 127-138.
- Ji, LL., Gomez-Cabrera, M. C., Vina, J., 2006. Exercise and hormesis: activation of cellular antioxidant signaling pathway. *Ann. N. Y. Acad. Sci.* 1067, 425-35.
- Jos, A., Pichardo, S., Prieto, A. I., Repetto, G., Vazquez, C. M., Moreno, I., Camean, A. M., 2005. Toxic cyanobacterial cells containing microcystins induce oxidative stress in exposed tilapia fish (*Oreochromis sp.*) under laboratory conditions. *Aquat. Toxicol.* 72, 261-271.
- Jung, V., Thibaut, T., Meinesz, A., Pohnert, G., 2002. Comparison of the wound-activated transformation of caulerpenyne by invasive and noninvasive *Caulerpa* species of the Mediterranean. *J. Chem. Ecol.* 28, 2091-21055.
- Kondo, F., Matsumoto, H., Yamada, S., Ishikawa, N., Ito, E., Nagata, S., Ueno, Y., Suzuki, M., Harada, K., 1996. Detection and identification of metabolites of microcystins formed in vivo in mouse and rat livers. *Chem. Res. Toxicol.* 9, 1355-1359.

- Michel, C., Lejeune, P., Voss, J., 1987. Biologie et comportement des Labridés européens. *Revue française d'Aquariologie et d'Herpéthologie* 14, 1–180.
- Livinstone, D.R., 2001. Contaminant-stimulated reactive oxygen species production and oxidative damage in aquatic organisms. *Mar. Pollut. Bull.* 42, 656-666.
- Lushchak, V. I., Bagnyukoca, T. V., 2006. Effects of different environmental oxygen levels on free radical processes in fish. *Comp. Biochem. Physiol., B.* 144, 283-289.
- Mahendran, M., Somasundaram, S., Thomson, R.H., 1979. Revised structure for saulerpicin from *Caulerpa racemosa*. *Phytochemistry.* 18, 1885-1886.
- Maiti, B.C., Thomson, R.H., Mahendran, M., 1978. Structure of caulerpin, a pigment from *Caulerpa* algae. *J. Chem. Res.* 126-127.
- Meinesz, A., 1979. Contribution to the study of *Caulerpa prolifera* (Forsskal) Lamouroux (Chlorophyceae, Caulerpales) .1. Morphogenesis and growth at a station off the French continental coast of the Mediterranean Sea. *Botanica Marina.* 22, 27-39.
- Meinesz, A., Devaugelas, J., Hesse, B., Mari, X., 1993. Spread of the introduced tropical green alga *Caulerpa taxifolia* in Northern Mediterranean waters. *J. Appl. Phycol.* 5, 141-147.
- Meinesz, A., Hesse, B., 1991. Introduction of the tropical alga *Caulerpa taxifolia* and its invasion of the Northwestern Mediterranean. *Oceanologica Acta.* 14, 415-426.
- Mozzachiodi, R., Scuri, R., Roberto, M., Brunelli, M., 2001. Caulerpenyne, a toxin from the seaweed *Caulerpa taxifolia*, depresses after hyperpolarization in invertebrate neurons. *Neuroscience* 107, 519-526.
- Nielsen, P.G., Carle, J.S., Christophersen, C., 1982. Final structure of caulerpicin, a toxin mixture from the green alga *Caulerpa racemosa*. *Phytochemistry.* 21, 1643-1645.
- Niwa, Y., Ozaki, T., Kanoh, T., Akamatsu, H., Kurisaka, M., 1996. Role of cytokines, tyrosine kinase and protein kinase C on production of superoxide and induction of scavenging enzymes in human leukocytes. *Clin. Immunol. Immunopathol.* 79, 303-313.
- ParentMassin, D., Fournier, V., Amade, P., Lemee, R., DurandClement, M., Delescluse, C., Pesando, D., 1996. Evaluation of the toxicological risk to humans of caulerpenyne using human hematopoietic progenitors, melanocytes, and keratinocytes in culture. *J. Toxicol. Environ. Health.* 47, 47-59.

- Pastore, A., Federici, G., Bertini, E., Piemonte, F., 2003. Analysis of glutathione: implication in redox and detoxification. *Clin. Chim. Acta.* 333, 10-39.
- Pffugmacher, S., Wiegand, C., Oberemm, A., Beattie, K.A., Krause, E., Codd, G.A., Steinberg, C., 1998. Identification of an enzymatically-formed glutathione conjugated of the cyanobacterial hepatotoxin microcystin-LR. The first step of detoxification. *Biochem. Biophys. Acta.* 1425, 527-533.
- Pinnegar, J.K., Polunin, N.V.C., 2000. Contributions of stable-isotope data to elucidating food webs of Mediterranean rocky littoral fishes. *Oecologia.* 122, 399-409.
- Pohnert, G., Jung, V., 2003. Intracellular compartmentation in the biosynthesis of caulerpenyne: Study on intact macroalgae using stable-isotope-labeled precursors. *Organic Letters.* 5, 5091-5093.
- Porte, C., Escartin, E., García de la Parra, L.M., Biosca, X., Albaigés, J., 2002. Assessment of coastal pollution by combined determination of chemical and biochemical markers in *Mullus Barbatulus*. *Mar. Ecol. Prog. Ser.* 235, 205-216.
- Prohaska, J. R., 1980. The glutathione peroxidase activity of glutathione S-transferases. *Biochim. Biophys. Acta.* 611, 87-98.
- Sayeed, I., Parvaez, S., Pandey, S., Bin-Hafeez, B., Haque, R., Raisuddin, S., 2003. Oxidative stress biomarkers of exposure to deltamethrin in freshwater fish, *Channa punctatus* Bloch. *Ecotoxicol. Environ. Safe.* 56, 295-301.
- Schwede, J.G., Cardellina, J.H., Grode, S.H., James, T.R., Blackman, A.J., 1987. Distribution of the pigment caulerpin in species of the green alga *Caulerpa*. *Phytochemistry.* 26, 155-158.
- Shi, H., Sui, Y., Wang, X., Luo, Y., Ji, L., 2005. Hydroxyl radical production and oxidative damage induced by cadmium and naphtalene in liver of *Carassius auratus*. *Comp. Biochem. Physiol., C.* 140, 115-121.
- Sureda A., Batle J. M., Tauler P., Cases N., Aguilo A., Tur J. A., Pons A., 2004. Neutrophil tolerance to oxidative stress induced by hypoxia/reoxygenation. *Free Radic. Res.* 38, 1003-1009.
- Thibaut, T., Meinesz, A., Amade, P., Charrier, S., De Angelis, K., Ierardi, S., Mangialajo, L., Melnick, J., Vidal, V., 2001. *Elysia subornata* (Mollusca) a potential control agent of the alga *Caulerpa taxifolia* (Chlorophyta) in the Mediterranean Sea. *J. Mar. Biol. Assoc. U.K.* 81, 497-504.

- Towner, R. A., Sturgeon, S.A., Hore, K. E., 2002. Assessment of in vivo oxidative lipid metabolism following acute microcystin-LR-induced hepatotoxicity in rats. *Free Radic. Res.* 36, 63-71.
- Uchimura, M., Sandeaux, R., Larroque, C., 1999. The enzymatic detoxifying system of a native Mediterranean Scorpio fish is affected by *Caulerpa taxifolia* in its environment. *Environ. Sci. Technol.* 33, 1671-1674.
- Verlaque, M., Fritayre, P. (1994) Mediterranean algal communities are changing in the face of the invasive alga *Caulerpa taxifolia* (Vahl). *Oceanologica Acta.* 17, 659-672.
- Winston, G. W., Di Giulio, R. T., 1991. Prooxidant and antioxidant mechanisms in aquatic organisms. *Aquat. Toxicol.* 19, 137-161.

6.4 Reciprocal effects of caulerpenyne and intense herbivorism on the antioxidant response of *Bittium reticulatum* and *Caulerpa taxifolia*

Abstract

We studied the antioxidant enzyme response of the gastropoda *Bittium reticulatum* feeding the toxic alga *Caulerpa taxifolia*, and also the effects of intense herbivorism on caulerpenyne production and on the antioxidant response of *Caulerpa taxifolia*. *Bittium reticulatum* were maintained in two separated aquariums containing *Posidonia oceanica* or *Caulerpa taxifolia*. Glutathione peroxidase, glutathione reductase and glutathione S-transferase activities were significantly higher in *Bittium reticulatum* living in presence of *Caulerpa taxifolia* respect to animals living in *Posidonia oceanica* aquarium. Malondialdehyde levels in *Bittium reticulatum* showed similar values in both environments. Caulerpenyne levels were significantly higher in *Caulerpa taxifolia* fronds after herbivore exposure. *Caulerpa taxifolia* activities of catalase and glutathione reductase increased significantly in presence of *Bittium reticulatum*. *Bittium reticulatum* exposed to caulerpenyne evidenced antioxidant enzyme adaptations to prevent oxidative damage. The presence of *Bittium reticulatum* in the aquarium induces a protective adaptation in *Caulerpa taxifolia* in order to reduce the herbivorism.

Keywords: *Caulerpa taxifolia*, *Bittium reticulatum*, caulerpenyne, antioxidant enzymes, lipid peroxidation, Balearic Islands

Introduction

Numerous green algae (Chlorophyta) are especially deterrent to herbivores by producing repulsive and toxic secondary metabolites (Doty 1966; Maiti et al. 1978; Mahendran et al. 1979; Nielsen et al. 1982; Schwede et al. 1987; Jung et al. 2002). Caulerpenyne is the main secondary metabolite synthesized by the *Caulerpa* green marine algae family (Ulvophyceae, Caulerpales), playing a major role in its chemical defense (Pohnert and Jung 2003). It inhibits the growth of microorganisms, interferes with the development of fertilized sea urchin eggs, and it has cytotoxic effects in mammalian cells (ParentMassin et al. 1996; Pesando et al. 1998; Barbier et al. 2001). Some studies evidenced reduced grazing pressure by some fish and invertebrates (Gollan and Wright, 2006), whereas other ones with herbivorous tropical fishes showed that caulerpenyne does not defend the plants against herbivores (Meyer and Paul 1992). Caulerpenyne from *Caulerpa* spp. is transformed into the more toxic and deterrent oxytoxins when the algae are wounded (Gavagnin et al. 1994; Jung and Pohnert 2001).

The seaweed of tropical origin algae *Caulerpa taxifolia* (Vahl) C. Agardh was introduced in the Mediterranean Sea in 1984 (Meinesz and Hesse 1991). In a decade, *C. taxifolia* has rapidly spread along the western Mediterranean after its introduction and has thereby massively altered the native ecosystems of these regions (Meinesz et al. 1993; Meinesz 2004). *C. taxifolia* has colonized a wide variety of substrates in a wide depth range covering the infralittoral zone, competing with autochthonous flora (Verlaque and Fritayre 1994) and decreasing the mean species richness (Arigoni et al. 2002; Harmelin-Vivien, 1999 #212). *C. taxifolia* is also a major problem in Australia. In fact, many studies showed impacts of *C. taxifolia* on the diversity and abundance of native species such as the native bivalve *Anadara trapezia* (Deshayes, 1840) (Gribben and Wright, 2006; Wright et al., 2007).

Cellular oxidative metabolism is a continuous source of reactive oxygen species (ROS), resulting from univalent reduction of O₂, that can damage most cellular components. Cells contain a complex network of antioxidant defense that scavenge or prevent the generation of ROS, and repair or remove the damaged molecules (Elias et al. 1999). The antioxidant system involves enzymes such as superoxide dismutase (SOD), catalase (CAT), glutathione peroxidase (GPx) and glutathione reductase (GR) that act by detoxifying the ROS generated. Moreover, glutathione S-transferase (GST)

produces a glutathione conjugate that seems to be the first step in the detoxification of several toxins. This enzyme also plays a role in protection against oxidative stress by catalysing a selenium-independent glutathione-peroxidase activity (Prohaska 1980). Nevertheless, under several situations, the rate of generation of ROS exceeds that of their removal, inducing oxidative stress and increasing oxidative markers. It is well established that pollutants such as various pesticides (Sayeed et al. 2003) and metals (Almeida et al. 2002) stimulate protective mechanisms against ROS. In addition, naturally occurring toxicans such as microcystins, a family of cyclic peptide toxins produced by cyanobacteria, are also capable of inducing oxidative stress (Jos et al. 2005). In a previous study, we have evidenced that the production of caulerpenyne by *Caulerpa* species induced an antioxidant adaptation in the liver of the labridae fish *Coris julis* in order to prevent oxidative damage (Sureda et al. 2006).

Marine organisms are continuously exposed to a wide variety of environmental factors such as contaminants leading to an increased ROS production (Livingstone 2001; Shi et al. 2005). An adjustment in antioxidant defences is required in order to maintain the steady-state concentration of ROS to prevent oxidative stress and cellular damage. The antioxidant enzyme induction reflects a specific response to pollutants and they have been proposed as biomarkers of contaminant-mediated oxidative stress in a variety of marine organisms (Livingstone 2001; Camus et al. 2004; Sureda et al. 2006). Small marine herbivores with limited mobility (mesograzers) often feed on macroalgae chemically defended against fishes or sea-urchins. In a previous work, it was observed a high presence of *Bittium reticulatum* (gastropoda) in *Caulerpa* mats and *P. oceanica* seagrass (Murillo and Talavera 1983). We studied in a controlled environment the antioxidant enzyme response and the existence of cellular oxidative damage in *Bittium reticulatum* exposed to caulerpenyne to determinate the toxicological effects over this gastropoda. Moreover, in the way that macroalgae generate metabolites to avoid the herbivorism and, we also studied the effects of intense herbivorism on the caulerpenyne production and on the antioxidant defenses of *Caulerpa taxifolia*.

Experimental procedure

Experimental animals

Caulerpa taxifolia and *Posidonia oceanica* were collected in Cala d'Or (Mallorca, Spain) at a depth of 7-8 m. Algae samples presented undamaged fronds without signs of herbivory to ensure correct initial values. Macroalgae were immediately transported to the laboratory in an aerated aquarium and introduced in separate aquariums (six aquariums with *C. taxifolia* and six aquariums with *P. oceanica*). Macroalgae samples were maintained in aerated aquariums at 20-24°C with a day cycle of 12:12 L:D one month before introducing the herbivores.

Bittium reticulatum specimens were caught alive by scuba using hand-net of 500 µm mesh size in a *Posidonia* seagrass. Animals were kept in a *P. oceanica* aquarium with through-flowing filtered water. The water of the aquarium was renewed every three weeks with fresh seawater. After two weeks of acclimation, animals were collected and distributed in six separate aquariums containing the *P. oceanica* or in six aquariums containing the *C. taxifolia*. *B. reticulatum* were living in the new aquariums for one week.

In a parallel experiment, the abundances of *B. reticulatum* living in *C. taxifolia* and *P. oceanica* areas were determined. Six replicate samples were randomly collected from both areas with a 20x20 square fixed 5 cm into the sediment. Samples were placed into 500 µm mesh bag and transported to the laboratory. *B. reticulatum* and primary producers were sorted from the collected samples and the samples collected in *C. taxifolia* areas were also prepared for stable isotopes analyses.

Caulerpenyne determination

Caulerpenyne contents were measured in fronds of *C. taxifolia*. The caulerpenyne concentration was measured at the beginning of the experiment when *Bittium reticulatum* were placed in the aquarium and at the end of the experiment, one week later, when animals were collected. Algae samples were quickly washed in fresh water to remove salt and dried with absorbent paper. Then, 5 g were placed in 50 ml of methanol to obtain the crude methanolic extracts. The extracts were immediately

filtered on silica columns. Each sample was eluted with 5 ml of a mixture of methanol:ethyl acetate 50:50. Caulerpenyne concentration was determined using a HPLC method. The mobile phase consisted of 80:20 methanol:H₂O. The HPLC was a Shimadzu with a diode array detector and the column was a Nova Pak, C18, 3.9 x 150 mm. Caulerpenyne was determined at 254 nm and was quantified by comparison to a standard curve of known concentration. Pure caulerpenyne to establish an standard curve was provided by Dr. Philippe Amade (Equipe Antitumoraux Naturels, Universite Nice, Sophie Antipolis). Three different samples were collected from the aquaria, and the caulerpenyne concentration was measured in duplicate.

Sample processing

A pool of 10 animals from each aquarium (N=6 replicates for each treatment) were homogenized in ten volumes (w/v) of 100 mM Tris-HCl buffer pH 7.5. Homogenates were centrifuged at 9000 g, 10 min, 4°C and supernatants were recovered. *Caulerpa* samples were ground in liquid nitrogen using a mortar. Then, samples were homogenized in the same Tris-HCl buffer and subsequently centrifuged at 9000 g for 10 min at 4°C. Antioxidant enzyme activities were determined on the supernatants. All results were referred to the protein content in the samples (Biorad Protein Assay[®]).

Enzymatic activities

All enzyme activities were determined with a Shimadzu UV-2100 spectrophotometer at 37°C. CAT activity was measured by the spectrophotometric method of Aebi (Aebi 1984) based on the decomposition of H₂O₂ in 50 mM phosphate buffer. GPx activity was measured using an adaptation of the spectrophotometric method of Flohé and Gunzler (Flohe and Gunzler 1984). This activity was determined with hydrogen peroxide (H₂O₂) and GSH as substrates and GR and NADPH as enzyme and non-enzymatic indicators, respectively. GR activity was measured by a modification of the Goldberg and Spooner method (Goldberg and Spooner 1984), which required oxidized glutathione (GSSG) as substrate. GST activity was measured by the method of Habig (Habig et al. 1974) using reduced glutathione (GSH) and 1-chloro-2,4-dinitrobenzene (CDNB) as substrates.

MDA determination

Malondialdehyde (MDA), as a marker of lipid peroxidation, was analyzed by a colorimetric assay kit (Calbiochem, San Diego, CA, USA) following the manufacturer's instructions. Briefly, homogenates or standard were placed in a glass tubes containing n-methyl-2-phenylindole (10.3 mM) in acetonitril:methanol (3:1). HCl 12 N was added and samples were incubated one hour at 45 °C. The absorbance was measured at 586 nm. MDA concentration was calculated using standard curve of known concentration.

Isotopic analysis

Isotopic analyses were executed on whole body of *B. reticulatum* (pooled organisms without shell) from the *C. taxifolia* areas. Dissected tissues were rinsed with distilled water to clean residual salt and carbonates. *C. taxifolia*, *P. oceanica* and other macroalgae were cleaned of epiphytes and rinsed with distilled water.

Each dried sample was ground to a homogeneous powder. 1.9 to 2.1 mg of this homogeneous was weighed in ultra clean tin capsules and was combusted for nitrogen and carbon stable isotope compositions using continuous flow isotope ratio mass spectrometry (CF-IRMS) THERMO delta X PLUS mass spectrometer. In order to calibrate the system, 2 samples of reference material were analysed after every 8 samples. Reference material used for carbon and nitrogen stables isotopes analysis were Peach Leave Standard (1547) (PLS) and Bovine Liver Standard (1577b) (BSA) (U.S. Department of Commerce, National institute of standards and technology, Gaithersburg, MD 20899). The $\delta^{13}\text{C}$ and $\delta^{15}\text{N}$ deviations of 332 analyses of a regularly calibrated working reference, were for PLS, 0.06‰ and 0.09‰ respectively, and for BSA, 0.09‰ and 0.12‰, respectively.

Stable isotope abundances were measured by comparing the ratio of the two most abundant isotopes (e.g. $^{13}\text{C}:^{12}\text{C}$ and $^{15}\text{N}:^{14}\text{N}$) in the sample to international isotopic standards. Results are expressed in terms of parts per thousand (‰) deviations from the standards according to the following equation: $\delta X = [(R_{\text{sample}}/R_{\text{reference}})-1] \times 10^3$, where X is either ^{13}C or ^{15}N and R is the corresponding $^{13}\text{C}/^{12}\text{C}$ and $^{15}\text{N}/^{14}\text{N}$ ratio (Peterson and Fry, 1987).

Statistical Analysis

Statistical analysis was carried out using a statistical package (SPSS 12.0 for Windows®). Differences between means were calculated using one-way analysis of variance (ANOVA) after log transformation using Levene's test for equality of variance and to evaluate a normal distribution of data. A probability level (P) of significance of $P < 0.05$ was considered statistically significant. Mean values and s.e.m. are shown. The Isosource software® (Phillips and Gregg, 2003; Phillips et al., 2005) was used to estimate the potential contributions of the primary producers groups to the first order consumers.

Results

The abundances of *B. reticulatum* collected in *C. taxifolia* were 25 ± 5 individuals / m^2 and in *P. oceanica* were 8 ± 3 individuals / m^2 ($F(1,10) = 10.1, p = 0.01$) (Figure 1). The samples collected in the *C. taxifolia* areas contained other macroalgae: *C. prolifera*, *Padina pavonica*, *Halimeda tuna*, *Halotheis filicina*, *Corallina* sp., *Dictyota dichotoma* and the seagrass *P. oceanica*. All these primary producers were used for stable isotopes analyses.

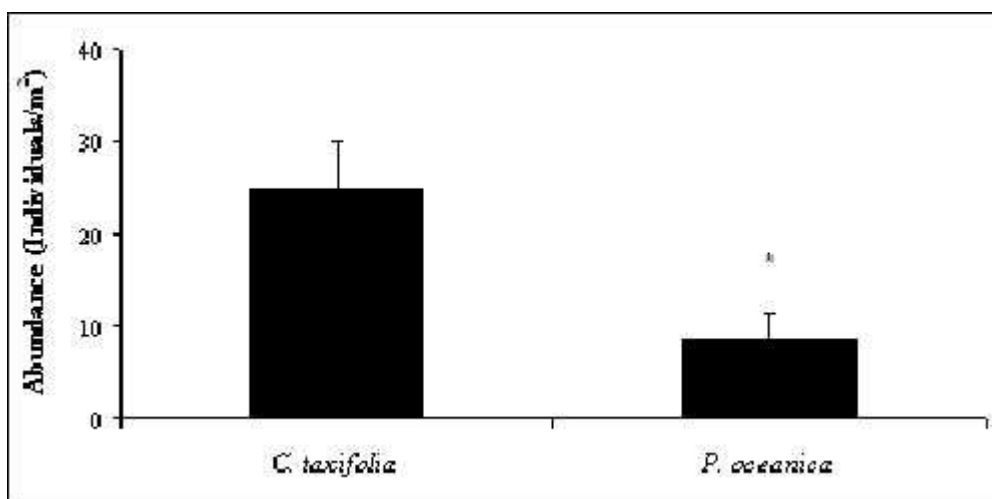

Figure 1. *Bittium reticulatum* abundances in *Posidonia oceanica* and *Caulerpa taxifolia* areas. One-way ANOVA. Values were computed as means \pm S.E.M. (*) Indicates significant differences between initial and final concentration, $p < 0.05$.

Mixing model (Isosource) outputs for $\delta^{13}\text{C}$ and $\delta^{15}\text{N}$ showed that *Dictyota dichotoma*, *C. prolifera* and *C. taxifolia* were the main algae contributing to the diet of the gastropoda *B. reticulatum* (Table 1). *Dictyota dichotoma* contributed with 22%, *C. prolifera* with 22% and *C. taxifolia* with 21% to the diet of *B. reticulatum* living in the areas with *C. taxifolia*, whereas the contribution of *P. oceanica* in this area was only 6%. These results suggested an herbivorous pressure over the invasive macroalgae *C. taxifolia* associated to the presence of *B. reticulatum* and consequently supports the aquarium experiments about the herbivorous pressure of *B. reticulatum* over *C. taxifolia*.

Table 1. Mean 1st to 99th percentiles and range of probable contributions (proportion) of primary producers to *Bittium reticulatum* diet.

	Mean	1-99 Percentile	Range
<i>Caulerpa prolifera</i>	0.219	0.00-0.55	0.00-0.95
<i>Caulerpa taxifolia</i>	0.211	0.00-0.65	0.00-0.99
<i>Corallina</i> sp.	0.078	0.00-0.35	0.00-0.45
<i>Dictyota dichotoma</i>	0.222	0.00-0.65	0.00-0.95
<i>Halimeda tuna</i>	0.102	0.00-0.45	0.00-0.70
<i>Halopteris filicina</i>	0.169	0.00-0.65	0.00-0.99
<i>Padina pavonica</i>	0.028	0.00-0.15	0.00-0.20
<i>Posidonia oceanica</i>	0.061	0.00-0.30	0.00-0.40

In the aquarium study, fronds and stolons of *Caulerpa* growing in the aquariums with *B. reticulatum* showed signals of herbivorism with visual evidence of *Bittium* feeding.

Caulerpenyne concentration measured in fronds from *C. taxifolia* is presented in Figure 2. No caulerpenyne was detected in the seagrass *P. oceanica*. The levels of caulerpenyne were significantly higher in fronds of *C. taxifolia* at the end of the experiment after one week of cohabitate *C. taxifolia* with *B. reticulatum* (initial values: 3.33 ± 0.43 mg caulerpenyne/g DW, final values: 6.28 ± 0.61 mg caulerpenyne/g DW, $F(1,10)= 15.2, p=0.003$).

The antioxidant enzyme activities and MDA levels in *B. reticulatum* homogenates living in the *C. taxifolia* aquarium and in the *P. oceanica* aquarium without caulerpenyne are shown in Table 2. We measured the antioxidant enzyme

activities –CAT, GPx, GR and GST- as markers of oxidative stress. CAT presented similar activities in animals from both aquariums ($p=0.80$). GPx (10.8 ± 1.0 vs. 13.9 ± 0.8 nKat/mg prot, $F(1,10)=5.49$, $p<0.05$), GR (15.1 ± 2.1 vs. 23.7 ± 2.3 nKat/mg prot, $F(1,10)=7.43$, $p=0.02$) and GST (211 ± 20 vs. 278 ± 24 nKat/mg prot, $F(1,10)=5.26$, $p<0.05$) activities were significantly higher in animals living in presence of *C. taxifolia* respect to animals living in *P. oceanica* aquarium. MDA concentration, used to evaluate the lipid peroxidative status in caulerpenyne exposed and non-exposed animals, showed no significant differences between the two different environments ($p=0.44$).

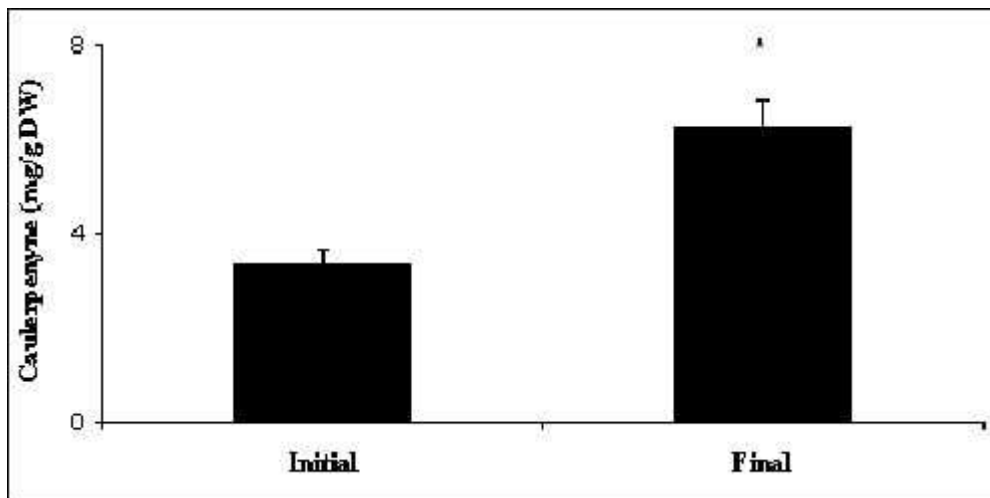

Figure 2. Caulerpenyne concentration in fronds from *Caulerpa taxifolia* before and after exposure to *Bittium reticulatum*. Values were computed as means \pm S.E.M. One-way ANOVA. (*) Indicates significant differences between initial and final concentration, $p<0.05$.

The antioxidant enzyme activities and MDA levels in *B. reticulatum* homogenates living in the *C. taxifolia* aquarium and in the *P. oceanica* aquarium without caulerpenyne are shown in Table 2. We measured the antioxidant enzyme activities –CAT, GPx, GR and GST- as markers of oxidative stress. CAT presented similar activities in animals from both aquariums ($p=0.80$). GPx (10.8 ± 1.0 vs. 13.9 ± 0.8 nKat/mg prot, $F(1,10)=5.49$, $p<0.05$), GR (15.1 ± 2.1 vs. 23.7 ± 2.3 nKat/mg prot, $F(1,10)=7.43$, $p=0.02$) and GST (211 ± 20 vs. 278 ± 24 nKat/mg prot, $F(1,10)=5.26$, $p<0.05$) activities were significantly higher in animals living in presence of *C. taxifolia* respect to animals living in *P. oceanica* aquarium. MDA concentration, used to evaluate the lipid peroxidative status in caulerpenyne exposed and non-exposed animals, showed no significant differences between the two different environments ($p=0.44$).

Table 2: Antioxidant enzyme activities and MDA levels in *Bittium reticulatum*. One-way ANOVA. (*) Indicates significant differences between *Posidonia oceanica* and *C. taxifolia*, $p < 0.05$.

	<i>P. oceanica</i>	<i>C. taxifolia</i>
CAT		
K/mg prot	43.1 ± 5.1	44.9 ± 4.5
GPx		
nKat/mg prot	10.8 ± 1.0	13.9 ± 0.8 *
GR		
nKat/mg prot	15.1 ± 2.1	23.7 ± 2.3 *
GST		
nKat/mg prot	211 ± 20	278 ± 24 *
MDA		
nmol/mg prot	5.23 ± 0.62	6.05 ± 0.98 *

Antioxidant enzyme activities in fronds of *C. taxifolia* are presented in Table 3. CAT and GR activities significantly increased in algae after cohabitating and suffering from herbivorism by the presence of *B. reticulatum*. CAT activity increased from 10.3 ± 0.7 to 17.9 ± 1.3 K/mg prot ($F(1,10)=25.9$, $p < 0.001$), and GR activity from 4.28 ± 0.37 to 5.40 ± 0.43 nKat/mg prot ($F(1,10)=5.44$, $p = 0.042$). GPx maintained the same values in both environments ($p = 0.79$).

Table 3: Antioxidant enzyme activities in fronds of *Caulerpa taxifolia*. One-way ANOVA. (*) Indicates significant differences between *C. taxifolia* aquariums and *C. taxifolia* + *Bittium reticulatum* aquariums. Values were computed as means ± S.E.M., $p < 0.05$.

	<i>Caulerpa taxifolia</i>	<i>C. taxifolia</i> + <i>Bittium reticulatum</i>
CAT		
K/mg prot	10.3 ± 0.7	17.9 ± 1.3 *
GPx		
nKat/mg prot	1.85 ± 0.19	1.79 ± 0.16
GR		
nKat/mg prot	4.28 ± 0.27	5.40 ± 0.43 *

Discussion

Field results reported the ingestion of *C. taxifolia* by the gastropoda *B. reticulatum*. This result means a great adaptability of this gastropoda specie to the ecosystem changes and explains its ubiquitous presence in the infralitoral waters according with previous studies (Dantard et al., 1991; Templado et al., 2004). Consequently, it is interesting to analyze the interaction between these two species under controlled conditions.

Cellular antioxidant status is used to evaluate the ability of organisms to resist an environmental stress such as some marine pollutants (Frenzilli et al. 2004). Correlations between the efficiency of ROS detoxification and the stress tolerance were reported by several authors (Porte et al. 2002; Cavas et al. 2005a). However, biological responses of environmentally exposed animals are often barely interpretable because of the high complexity of the pollutants and also because chronic exposure to low levels of contaminants can lead to physiological mechanisms of adaptation reducing the animal sensitivity to contaminants. We studied the effects of the secondary metabolite caulerpenyne from the invasive algae *C. taxifolia* in a controlled environment on the antioxidant system of a benthic invertebrate eating the alga.

It has been evidenced that algae produce higher concentrations of defensive compounds in areas subject to high herbivore pressure (Paul and Fenical 1986). However, when *Caulerpa* are in competition with *P. oceanica*, the algae is more inclined to accelerate vegetative growth than to produce secondary metabolites (Dumay et al. 2002). Here, we evidenced that the presence of *B. reticulatum* in the aquarium induces an increase in caulerpenyne production by the alga as result of the herbivorous pressure.

Caulerpenyne secreted by the members of genus *Caulerpa* presents toxic effects evidenced on various species (Parent-Massin et al. 1996; Brunelli et al. 2000; Barbier et al. 2001; Mozzachiodi et al. 2001). The present study shows a relationship between the presence of caulerpenyne and a higher antioxidant activity in *B. reticulatum* living in *Caulerpa* aquariums. It was reported that caulerpenyne production is positively correlated with temperature (Amade and Lemee 1998; Dumay et al. 2002) altering the antioxidant status of Sacoglossan species (Cavas et al. 2005a). In a previous study, it was evidenced that the enzymatic detoxifying system of Scorpio fish (*Scorpaena*

porcus) was affected by the presence of *C. taxifolia* in its aquarium (Uchimura et al. 1999a). We also evidenced an antioxidant adaptation in liver of the labridae *Coris julis* living in a *C. taxifolia* area (Sureda et al. 2006). The characteristics of caulerpenyne and particularly the presence of an acetylenic triple bond suggest that caulerpenyne detoxification could lead to the formation of reactive intermediates (Uchimura et al. 1999a). The higher GPx and GST activities in *Bittium reticulatum* observed after changing the diet to *Caulerpa* could be attributed to an enhanced biotransformation rate of caulerpenyne or repair of cellular components damaged by ROS. The GST activity requires GSH as a substrate, leading to a loss of GSH, whereas GPx activity results in the GSH oxidation to GSSG. The increased GPx and GST activities evidenced in the *Caulerpa* aquariums could contribute in decreasing the GSH content in cells. GSH is the most abundant cellular thiol and is involved in many metabolic processes (DeLeve and Kaplowitz 1991), playing a central role in the detoxification of ROS, which can be generated as by-products during the biotransformation of a variety of substances (Pastore et al. 2003). The maintenance of the GSH/GSSG ratio is essential for the normal cell metabolism. GR is the main system maintaining this ratio, catalyzing the reduction of GSSG to GSH in a NADPH-dependent reaction (Jos et al. 2005). The high activity of GR in *B. reticulatum* reflects a high GSSG reduction in order to recycle GSH in the reduced form.

Lipid peroxidation is a well-known mechanism of cellular injury and is an indicator of oxidative damage (Ahmad et al. 2006; Monteiro et al. 2006). Lipid peroxides, derived from polyunsaturated fatty acids, are unstable and decompose to form a complex series of compounds, being MDA the most abundant. It was evidenced an increase of MDA levels induced by pollutants (Pampanin et al. 2005). In the present experiment MDA levels were unchanged in *B. reticulatum* after exposure to caulerpenyne. Antioxidant enzymes of *B. reticulatum* significantly increased in response to the stress-induced by caulerpenyne avoiding significant lipid damage.

C. taxifolia also showed a protective response when *B. reticulatum* was introduced in the aquarium. The alga responded with an increase in caulerpenyne production in order to protect itself from herbivorous pressure reducing their palatability. The enhanced general metabolism associated to caulerpenyne synthesis could increase the antioxidant system. Furthermore, the tissue damage generated by herbivores could increase the production of ROS and consequently induces an antioxidant enzyme response to contribute to avoid and to repair the herbivorism-

induced oxidative damage. *B. reticulatum* feeding will probably promote oxidative cascades because damaged tissues could expose molecules susceptible to suffer oxidation and/or could liberate enzymes with pro-oxidative activities. The increase in ROS production could be also a strategy together with the increased caulerpenyne to reduce the grazing by *B. reticulatum*. Cavas and Yurdakoc (2005) suggested that the antioxidant status of *C. racemosa* could play a role in the control of epiphytism. The presence of higher catalase activity could be related to higher production of hydrogen peroxide to prevent epiphytism, or in our study to prevent herbivorism, by generating some halogenated compounds. It has been also evidenced that antioxidant enzymes activities are enhanced to counteract the cellular damage induced by stress conditions (Collen et al. 2003; Li et al. 2006).

In conclusion, antioxidant status of *B. reticulatum* was modified with the presence of caulerpenyne. Antioxidant enzyme activities were increased in animals living in *C. taxifolia* aquariums, but without evidence of increased lipid peroxidation. The new habitat generated after the colonization of *Caulerpa* species of sandy or rocky bottoms was suitable to support *B. reticulatum* populations. *C. taxifolia* may respond to herbivorism increasing the production of caulerpenyne to reduce their palatability and activating their antioxidant defenses. However, *B. reticulatum* seem able to continue feeding *C. taxifolia* at high levels of caulerpenyne synthesis without any negative impacts. More exhaustive field studies must be done to analyze the implications of the habitat change with other and to validate our hypothesis.

Acknowledgements

The authors are grateful to Philip Amade for his technical assistance. The authors are also grateful to the Stable Isotopes Laboratory from Science Technical Service of the University of Balearic Islands Stable for their isotope analyses. Antoni Box was supported by a program IP3 fellowship (CSIC).

References

- Aebi, H.E., 1984. Catalase. *Methods in Enzymatic Analysis*. 273-286.
- Ahmad, I., Pacheco, M., Santos, M.A., 2006. *Anguilla anguilla* L. oxidative stress biomarkers: An in situ study of freshwater wetland ecosystem (Pateira de Fermentelos, Portugal). *Chemosphere*. 65, 952-962.
- Almeida, J.A., Diniz, Y.S., Marques, S.F., Faine, L.A., Ribas, B.O., Burneiko, R.C., Novelli, E.L., 2002. The use of the oxidative stress responses as biomarkers in Nile tilapia (*Oreochromis niloticus*) exposed to in vivo cadmium contamination. *Environ. Int.* 27, 673-679.
- Amade, P., Lemee, R., 1998. Chemical defence of the Mediterranean alga *Caulerpa taxifolia*: variations in caulerpenyne production. *Aquatic Toxicology*. 43, 287-300.
- Arigoni, S., Francour, P., Harmelin-Vivien, M., Zaninetti, L., 2002. Adaptive colouration of Mediterranean labrid fishes to the new habitat provided by the introduced tropical alga *Caulerpa taxifolia*. *J. Fish Biol.* 60, 1486-1497.
- Barbier, P., Guise, S., Huitorel, P., Amade, P., Pesando, D., Briand, C., Peyrot, V., 2001a. Caulerpenyne from *Caulerpa taxifolia* has an antiproliferative activity on tumor cell line SK-N-SH and modifies the microtubule network. *Life Sciences*. 70, 415-429.
- Brunelli, M., Garcia-Gil, M., Mozzachiodi, R., Roberto, M., Scuri, R., Traina, G., Zaccardi, M.L., 2000. Neurotoxic effects of caulerpenyne. *Prog. Neuropsychopharmacol. Biol. Psychiatry*. 24, 939-954.
- Camus, L., Pampanin, D.M., Volpato, E., Delaney, E., Sanni, S., Nasci, C., 2004. Total oxyradical scavenging capacity responses in *Mytilus galloprovincialis* transplanted into the Venice lagoon (Italy) to measure the biological impact of anthropogenic activities. *Mar. Pollut. Bull.* 49, 801-808.
- Cavas, L., Yurdakoc, K., Yokes, B., 2005. Antioxidant status of *Lobiger serradifalci* and *Oxynoe olivacea* (Opisthobranchia, Mollusca). *J. Exp. Mar. Biol. Ecol.* 314, 227-235.
- Cavas, L., Yurdakoc, K., 2005. A comparative study: Assessment of the antioxidant system in the invasive green alga *Caulerpa racemosa* and some macrophytes from the Mediterranean. *J. Exp. Marine Biol. Ecol.* 321, 35-41.

- Collen, J., Pinto, E., Pedersen, M., Colepicolo, P., 2003. Induction of oxidative stress in the red macroalga *Gracilaria tenuistipitata* by pollutant metals. Arch. Environ. Contam. Toxicol. 45, 337-342.
- Damtart, M., Frechilla, M., Ballesteros, M., 1990. Fauna malacologica del Estany des Peix (Formentera). IBERUS. 9, 111-125.
- Davis, A.R., Benkendorff, K., Ward, D.W., 2005. Responses of common SE Australian herbivores to three suspected invasive *Caulerpa* spp. Mar. Biol. 146, 859–868.
- DeLeve, L.D., Kaplowitz, N., 1991. Glutathione metabolism and its role in hepatotoxicity. Pharmacol. Ther. 52, 287-305.
- Doty, M.S., 1966. Caulerpicin a Toxic Constituent of Caulerpa. Nature. 211, 990-&.
- Dumay, O., Pergent, G., Pergent-Martini, C., Amade, P., 2002. Variations in caulerpenyne contents in *Caulerpa taxifolia* and *Caulerpa racemosa*. J. Chem. Ecol. 28, 343-352.
- Elias, S.J., Arner, E.S., Zhong, L., Holmgren, A., 1999. In: Packer L (ed) Methods in Enzymatic Analysis. Oxidants and Antioxidants. Academic Press, California. vol. 300, pp 226-239.
- Flohe, L., Gunzler, W.A., 1984. Assays for glutathione peroxidase. Methods Enzymol. 105, 114-121.
- Frenzilli, G., Bocchetti, R., Pagliarecci, M., Nigro, M., Annarumma, F., Scarcelli, V., Fattorini, D., Regoli, F., 2004. Time-course evaluation of ROS-mediated toxicity in mussels, *Mytilus galloprovincialis*, during a field translocation experiment. Mar. Environ. Res. 58, 609-613.
- Gavagnin, M., Marin, A., Castelluccio, F., Villani, G., Cimino, G., 1994. Defensive relationships between *Caulerpa prolifera* and its shelled sacoglossan predators. J. Exp. Mar. Biol. Ecol. 175, 197-210.
- Goldberg, D.M., Spooner, R.J., 1984. Glutathione reductase. Methods Enzymatic Analysis. 258-265.
- Gollan, J.R., Wright, J.T., 2006. Limited grazing pressure by native herbivores on the invasive seaweed *Caulerpa taxifolia* in a temperate Australian estuary. Mar. freshw. res. 57, 685-694.
- Gribben, P.E., Wright, J.T., 2006. Sublethal effects on reproduction in native fauna: are females more vulnerable to biological invasion? Oecologia. 149, 352–361.
- Habig, W.H., Pabst, M.J., Jakoby, W.B., 1974. Glutathione S-transferases. The first enzymatic step in mercapturic acid formation. J. Biol. Chem. 249, 7130-7139.

- Harmelin-Vivien, M., Francour, P., Harmelin, J.G., 1999. Impact of *Caulerpa taxifolia* on Mediterranean fish assemblages: a six year study. In Proceedings of the Workshop on Invasive *Caulerpa* in the Mediterranean. MAP technical Reports Series. UNEP, Athens, pp. 127-138.
- Jos, A., Pichardo, S., Prieto, A.I., Repetto, G., Vazquez, C.M., Moreno, I., Camean, A.M., 2005. Toxic cyanobacterial cells containing microcystins induce oxidative stress in exposed tilapia fish (*Oreochromis* sp.) under laboratory conditions. *Aquat. Toxicol.* 72, 261-271.
- Jung, V., Pohnert, G., 2001. Rapid wound-activated transformation of the green algal defensive metabolite caulerpenyne. *Tetrahedron.* 57, 7169-7172.
- Jung, V., Thibaut, T., Meinesz, A., Pohnert, G., 2002. Comparison of the wound-activated transformation of caulerpenyne by invasive and noninvasive *Caulerpa* species of the Mediterranean. *J. Chem. Ecol.* 28, 2091-2105.
- Li, M., Hu, C., Zhu, Q., Chen, L., Kong, Z., Liu, Z., 2006. Copper and zinc induction of lipid peroxidation and effects on antioxidant enzyme activities in the microalga *Pavlova viridis* (Prymnesiophyceae). *Chemosphere.* 62, 565-572.
- Livingstone, D.R., 2001. Contaminant-stimulated reactive oxygen species production and oxidative damage in aquatic organisms. *Mar. Pollut. Bull.* 42, 656-666.
- Mahendran, M., Somasundaram, S., Thomson, R.H., 1979. Revised structure for caulerpicin from *Caulerpa racemosa*. *Phytochemistry.* 18, 1885-1886.
- Maiti, B.C., Thomson, R.H., Mahendran, M., 1978. Structure of Caulerpin, a Pigment from *Caulerpa* Algae. *J. Chem. Res.* 126-127.
- Meinesz, A., 2004. *Caulerpa taxifolia* continues its invasion. *Biofutur.* 41-46.
- Meinesz, A., Devaugelas, J., Hesse, B., Mari, X., 1993. Spread of the introduced tropical green-alga *Caulerpa taxifolia* in Northern Mediterranean waters. *J. Appl. Phycol.* 5, 141-147.
- Meinesz, A., Hesse, B., 1991. Introduction of the tropical alga *Caulerpa taxifolia* and its invasion of the Northwestern Mediterranean. *Oceanologica Acta.* 14, 415-426.
- Meyer, K.D., Paul, V.J., 1992. Intraplant variations in secondary metabolite concentration in three species of *Caulerpa* (Chlorophyta: Caulerpales) and its effects on herbivorous fishes. *Mar. Ecol. Prog. Ser.* 82, 249-257.
- Monteiro, D.A., de Almeida, J.A., Rantin, F.T., Kalinin, A.L., 2006. Oxidative stress biomarkers in the freshwater characid fish, *Brycon cephalus*, exposed to

- organophosphorus insecticide Folisuper 600 (methyl parathion). *Comp. Biochem. Physiol. C Toxicol. Pharmacol.* 143, 141-149.
- Mozzachiodi, R., Scuri, R., Roberto, M., Brunelli, M., 2001. Caulerpenyne, a toxin from the seaweed *Caulerpa taxifolia*, depresses afterhyperpolarization in invertebrate neurons. *Neuroscience*. 107, 519-526.
- Murillo, G.L., Talavera, P.A., 1983. Aportación a la malacología de una laguna litoral: el mar menor (Murcia). *Iberus*. 3, 15-28.
- Nielsen, P.G., Carle, J.S., Christophersen, C., 1982. Final Structure of Caulerpigin, a Toxin Mixture from the Green alga *Caulerpa racemosa*. *Phytochemistry*. 21, 1643-1645.
- Pampanin, D.M., Camus, L., Gomiero, A., Marangon, I., Volpato, E., Nasci, C., 2005. Susceptibility to oxidative stress of mussels (*Mytilus galloprovincialis*) in the Venice Lagoon (Italy). *Mar. Pollut. Bull.* 50, 1548-1557.
- Parent-Massin, D., Fournier, V., Amade, P., Lemee, R., Durand-Clement, M., Delescluse, C., Pesando, D., 1996. Evaluation of the toxicological risk to humans of caulerpenyne using human hematopoietic progenitors, melanocytes, and keratinocytes in culture. *J. Toxicol. Environ. Health*. 47, 47-59.
- Pastore, A., Federici, G., Bertini, E., Piemonte, F., 2003. Analysis of glutathione: implication in redox and detoxification. *Clin. Chim. Acta*. 333, 19-39.
- Paul, V.J., Fenical, W., 1986. Chemical defense in tropical green algae, order Caulerpales. *Mar. Ecol. Prog. Ser.* 34, 157-169.
- Pesando, D., Huitorel, P., Dolcini, V., Amade, P., Girard, J.P., 1998. Caulerpenyne interferes with microtubule-dependent events during the first mitotic cycle of sea urchin eggs. *Eur. J. Cell. Biol.* 77, 19-26.
- Peterson, B.J., Fry, B., 1987. Stable isotopes in ecosystem studies. *Ann. Rev. Ecol. Sys.* 18, 293-320.
- Phillips, D.L., Gregg, J.W., 2003. Source partitioning using stable isotopes: coping with too many sources. *Oecologia*. 136, 261-269.
- Phillips, D.L., Newsome S.D., Gregg, J.W., 2005. Combining sources in stable isotope mixing models: alternative methods. *Oecologia*. 144, 520-527.
- Pohnert, G., Jung, V., 2003. Intracellular compartmentation in the biosynthesis of caulerpenyne: Study on intact macroalgae using stable-isotope-labeled precursors. *Organic Letters*. 5, 5091-5093.

- Porte, C., Escartin, E., de la Parra, L.M.G., Biosca, X., Albaiges, J., 2002. Assessment of coastal pollution by combined determination of chemical and biochemical markers in *Mullus barbatus*. Mar. Ecol. Prog. Ser. 235, 205-216.
- Prohaska, J.R., 1980. The glutathione peroxidase activity of glutathione S-transferases. Biochim. Biophys. Acta. 611, 87-98.
- Sayeed, I., Parvez, S., Pandey, S., Bin-Hafeez, B., Haque, R., Raisuddin, S., 2003. Oxidative stress biomarkers of exposure to deltamethrin in freshwater fish, *Channa punctatus*. Ecotoxicol. Environ. Saf. 56, 295-301.
- Schwede, J.G., Cardellina, J.H., Grode, S.H., James, T.R., Blackman, A.J., 1987. Distribution of the pigment caulerpin in species of the green-alga *Caulerpa*. Phytochemistry. 26, 155-158.
- Shi, H., Sui, Y., Wang, X., Luo, Y., Ji, L., 2005. Hydroxyl radical production and oxidative damage induced by cadmium and naphthalene in liver of *Carassius auratus*. Comp. Biochem. Physiol. C Toxicol. Pharmacol. 140, 115-121.
- Sureda, A., Box, A., Ensenat, M., Alou, E., Tauler, P., Deudero, S., Pons, A., 2006. Enzymatic antioxidant response of a labrid fish (*Coris julis*) liver to environmental caulerpenyne. Comp. Biochem. Physiol. C Toxicol. Pharmacol. 144, 191-196.
- Templado, J., Ballesteros, E., García-Raso, J.E., San Martín, G.A., López-García, L., Salas, C., Luque, A., Sánchez-Lizaso, J.L., Moreno, D., 2004. In: Luque del Villar, A.A., Templado, J., (eds). Praderas y bosques marinos de Andalucía. Consejería de Medio Ambiente, Junta de Andalucía, Sevilla.
- Uchimura, K., Nagasaka, A., Hayashi, R., Makino, M., Nagata, M., Kakizawa, H., Kobayashi, T., Fujiwara, K., Kato, T., Iwase, K., Shinohara, R., Kato, K., Itoh, M., 1999. Changes in superoxide dismutase activities and concentrations and myeloperoxidase activities in leukocytes from patients with diabetes mellitus. J. Diab. Compl. 13, 264-270.
- Verlaque, M., Fritayre, P., 1994. Mediterranean algal communities are changing in the face of the invasive alga *Caulerpa taxifolia* (Vahl). Oceanologica Acta. 17, 659-672.
- Wright, J.T., McKenzie, L.A., Gribben, P.E., 2007. A decline in the abundance and condition of a native bivalve associated with *Caulerpa taxifolia* invasion. Mar. Freshw. Res. 58, 263-272.

6.5 Antioxidant response and caulerpenyne production of *Caulerpa taxifolia* (Vahl) C. Agardh epiphyted by the invasive algae *Lophocladia lallemandii* (Montagne)

Abstract

Invasive algae alter the structure and function of ecosystems. The red algae *Lophocladia lallemandii* grows in the West Mediterranean epiphyting the green algae *Caulerpa taxifolia*, another invasive alga. Our aim was to determine whether the invasive algae *Lophocladia*, recently introduced in the West Mediterranean, induces oxidative stress and an antioxidant response in *Caulerpa taxifolia*. We measured the caulerpenyne production, the activities of antioxidant enzymes and the levels of markers of lipid peroxidation in *Caulerpa taxifolia*. Caulerpenyne concentration was significantly higher in *Caulerpa taxifolia* epiphytized by *Lophocladia*. end-products of lipid peroxidation -malondialdehyde (MDA) and 4-hydroxynonenal (4-HNE)- were significantly increased in *Caulerpa taxifolia* samples from the station with *Lophocladia*. Antioxidant enzyme activities -catalase and superoxide dismutase (SOD)-, as well as H₂O₂ production increased significantly in the *Lophocladia* station compared to the control station. The activities of catalase and SOD determined in *Lophocladia lallemandii* showed no significant differences between *Lophocladia* living alone and *Lophocladia* epiphytating *Caulerpa taxifolia*. *Caulerpa taxifolia* epiphytized by *Lophocladia lallemandii* responded by increasing the caulerpenyne and H₂O₂ production and the antioxidant enzymes activities as a defensive mechanism against the new invasive algae.

Keywords: antioxidant enzymes; *Caulerpa taxifolia*; caulerpenyne; alien algae; lipid peroxidation; *Lophocladia lallemandii*.

Introduction

The introduction of species is recognized as a major driver of global change and the loss of biodiversity in ecosystems (Sakai et al. 2001). The growth of international shipping, aquaculture and aquarium trade promote the introduction of species in marine ecosystems (Boudouresque and Verlaque 2002) and increase the frequency of invasion events. Invasive species reduce the biodiversity and alter the structure and functioning of the invaded ecosystems (Mack et al. 2000; Boudouresque and Verlaque 2002; MacDougall and Turkington 2005).

The invasive chlorophyte aquarium-strain *Caulerpa taxifolia* (Vahl) C. Agardh was introduced in the Mediterranean in 1984 (Meinesz et al. 1993; Jousson et al. 1998). In two decades, *C. taxifolia* had spread in the western Mediterranean colonizing a variety of substrata in the 0-50 m depth range (Jaubert et al. 2003) affecting the autochthonous flora (Verlaque and Fritayre 1994; Devillele and Verlaque 1995; Piazzini et al. 2001a; Ceccherelli and Campo 2002; Ceccherelli et al. 2002; Balata et al. 2004). *C. taxifolia* seems to affect negatively the productivity of other macroalgae, likely through the toxic effect of the secondary metabolites that this species synthesizes (Ferrer et al. 1997). Caulerpenyne is the main secondary metabolite produced by *C. taxifolia* and it plays a major role in the algae chemical defense (Boudouresque et al. 1996; Amade and Lemee 1998; Sureda et al. 2006). The invasion of *C. taxifolia* reduces the availability of microhabitat to fishes resulting in a persistent decrease in mean species richness, density and biomass, when compared to indigenous communities living in *Posidonia oceanica* beds or in rocky areas (BellanSantini et al. 1996).

The red algae *Lophocladia lallemandii* (Montagne) F. Schmitz, considered an alien Mediterranean species introduced via Suez Channel, is widespread throughout the tropics and subtropics (Verlaque and Fritayre 1994; Boudouresque and Verlaque 2002), *Lophocladia* ssp. are a source of lophocladines, alkaloids with cytotoxic effects (Gross et al. 2006). *L. lallemandii* grows over all types of substrates (bare bedrocks, rocky macroalgae bottoms, *P. oceanica* seagrass meadows and over coralligenous communities) and affects the invertebrate community (Patzner 1998; Ballesteros 2006).

The cellular oxidative metabolism is a continuous source of reactive oxygen species (ROS) that can damage cellular components such as lipids, proteins and DNA. Cells contain a complex network of antioxidant defenses that scavenge or prevent the

generation of ROS, and repair or remove the damaged molecules (Elias et al. 1999). The antioxidant system involves enzymes such as superoxide dismutase (SOD) and catalase that act by detoxifying the ROS generated. If the ROS production is excessive or the antioxidant system is overwhelmed a situation of oxidative stress appears. High irradiance and temperature, or carbon deficiency may increase the production of ROS and cause oxidative stress in photosynthetic organisms (Asada 1999; Asada et al. 1999; Choo et al. 2004). The tolerance to stress of marine algae seems to be related to the metabolism of ROS. High levels of ROS scavenging enzymes and lower ROS-associated damage in the invasive chlorophyte *Caulerpa racemosa* var. *cylindracea* (Sonder) compared to those of other common Mediterranean macroalgal species has been linked to its success as an invador in the Mediterranean (Cavas and Yurdakoc 2005b).

Exposure to toxins, contaminants or hyperoxia also increases the production of ROS in marine organisms (Livingstone 2001; Shi et al. 2005). Caulerpenyne, an acetylenic sesquiterpene produced by *Caulerpa* species to deter herbivores (Boudouresque et al. 1996; Erickson et al. 2006) seems to promote changes in the metabolism of ROS in the liver of the labridae fish *Coris julis* that would counteract the oxidative damage caused by the detoxification process (Sureda et al. 2006).

The co-occurrence of *Caulerpa taxifolia* and *Lophocladia lallemandii* in a small bay on the East coast of Mallorca Island allowed us to study some aspects of the interaction between these two invasive species in the Mediterranean. *L. lallemandii* usually grows epiphytic over other macroalgae, including *C. taxifolia*. The production and release of hydrogen peroxide and brominated volatile halocarbons by macroalgae seem to share metabolic pathways (Collen et al. 1994) and it has been suggested as a possible mechanism by which macroalgae prevent the growth of epiphytes (Ohsawa et al. 2001; Choo et al. 2004). The high activities of ROS scavenging enzymes found in the invasive *Caulerpa racemosa* var. *cylindracea* compared to other Mediterranean macroalgae have been interpreted as indicative of the release of hydrogen peroxide by this species to prevent the growth of epiphytes and deter herbivores (Cavas and Yurdakoc 2005b). Indeed, the activities of ROS scavenging enzymes of *Caulerpa racemosa* var. *cylindracea* were higher in fronds that were not epiphytized than in those with epiphytes (Cavas and Yurdakoc 2005a)

The aim of our work was to determine whether the epiphytic growth of *L. lallemandii* induces oxidative stress in *C. taxifolia*, and if *L. lallemandii* shows signs of

oxidative stress when in contact with *C. taxifolia*. Furthermore, we also wanted to evaluate if the production of caulerpenyne by *C. taxifolia* is stimulated by the epiphytic growth of *L. lallemandii*.

Materials and Methods

Area description

Samples of *Caulerpa taxifolia* and *Lophocladia lallemandii* were collected by SCUBA diving in Cala d'Or (Mallorca, Balearic Islands, Western Mediterranean) in October 2006, when the biomass of the former species and the concentration of caulerpenyne are at their annual maximum (Fig 1). The algae were attached to the rhizomes of a dead meadow of the seagrass *Posidonia oceanica* (L.) located at a depth of 7 m. Six replicate samples of 10 g (fresh weight) of both algae were collected the same day in the following conditions: (1) *C. taxifolia* epiphytized by *L. lallemandii*, (2) *C. taxifolia* not epiphytized by *L. lallemandii*, and (3) *L. lallemandii* growing not in contact with *C. taxifolia*.

Caulerpenyne determination

To estimate the concentration of caulerpenyne in the fronds of *Caulerpa taxifolia*, samples were collected carefully to prevent the fragmentation of the algae and the transformation of caulerpenyne into reactive aldehydes (Amade and Lemee 1998) and, transported to the laboratory inside a portable cooler filled with fresh seawater at ambient temperature to prevent caulerpenyne degradation before extraction. Samples were quickly washed in fresh water to remove salts and dried with absorbent paper. Then, 5 g (fresh weight) were placed in 50 ml of methanol to obtain the crude methanolic extracts. The extracts were immediately filtered on silica columns. Each sample was eluted with 5 ml of a mixture of methanol:ethyl acetate 50:50. Caulerpenyne concentration was determined using a HPLC method. The mobile phase consisted of 80:20 methanol:H₂O. The HPLC was a Shimadzu with a diode array detector and the column was a Nova Pak, C18, 3.9 x 150 mm. Caulerpenyne was determined at 254 nm and was quantified by comparison to a standard curve of known

concentration. Pure caulerpenyne to establish a standard curve was provided by Dr. Philippe Amade (Equipe Antitumoraux Naturels, Université Nice, Sophie Antipolis). Caulerpenyne concentration was measured in duplicate in each sample.

Biochemical analyses

Malondialdehyde (MDA) and 4-Hydroxynonenal (4-HNE), markers of lipid peroxidation and, therefore, of ROS-associated damage were analyzed by a colorimetric assay kit (Calbiochem®, San Diego, CA, USA) following the manufacturer's instructions. Catalase and SOD enzyme activities were determined with a Shimadzu UV-2100 spectrophotometer at 37°C. CAT activity was measured by the spectrophotometric method of Aebi (Aebi 1984) based on the decomposition of H₂O₂ in 50 mM phosphate buffer and monitored at 234 nm. SOD activity was measured by an adaptation of the method of McCord and Fridovich (1969). The xanthine/xanthine oxidase system was used to generate the superoxide anion. This anion produced the reduction of cytochrome c, which was monitored at 550nm. The superoxide dismutase of the sample removed the superoxide anion and produced an inhibition of the reduction.

H₂O₂ production was assayed in *Caulerpa* homogenates by measuring the increase in fluorescence (530 nm excitation, 590 nm emission) due to the reaction of Amplex Red reagent (Molecular probes®) with H₂O₂ in the presence of horseradish peroxidase. Assays were performed at 25°C in a 96-well microplate fluorimeter (FLx800, Bio-tek instruments®). Homogenates were added in each well containing horseradish peroxidase 0.1 U/ml and Amplex Red reagent 10 µM. The rate of H₂O₂ production was calculated using a standard curve of H₂O₂.

Enzymatic activities, markers of lipid peroxidation and H₂O₂ production were expressed in a per mg protein basis, after the determination of the protein content of the algal samples using a commercial kit (Biorad®).

Statistical analysis was carried out using a statistical package (SPSS 14.0 for Windows®). The statistical significance was compared by one-way analysis of variance (ANOVA). Results are expressed as mean +/- S.E.M. and $P < 0.05$ was considered statistically significant.

Results

Caulerpenyne concentration measured in fronds of *Caulerpa taxifolia* are presented in Figure 1. The concentration of caulerpenyne in the fronds of *Caulerpa taxifolia* (expressed per wet weight) was higher in the fronds epiphytized with *Lophocladia lallemandii* (Fig. 2). than in those not epiphytized ($3.19 \pm 0.49 \mu\text{g}/\text{mg WW}$ vs. $4.87 \pm 0.44 \mu\text{g}/\text{mg WW}$, $p < 0.05$).

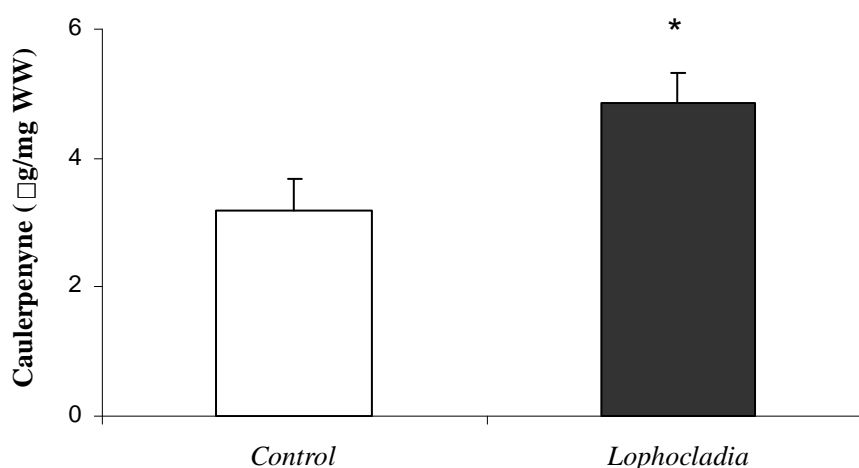

Figure 1: Caulerpenyne concentrations in *Caulerpa taxifolia* (control) and *C. taxifolia* epiphytized by *Lophocladia lallemandii*. (*) Indicates significant differences between control and epiphytized *C. taxifolia* caulerpenyne concentration, (ANOVA, $p < 0.05$).

The concentration of MDA and 4-HNE (Fig. 3) were higher in the fronds of *Caulerpa taxifolia* epiphytized by *Lophocladia lallemandii* than in those not epiphytized. The concentration of MDA increased by 57% (from $6.03 \pm 0.56 \text{ nmol}/\text{mg prot}$ to $9.48 \pm 0.79 \text{ nmol}/\text{mg prot}$, $p < 0.05$) and the concentration of 4-HNE increased by 53% (from $2.80 \pm 0.35 \text{ nmol}/\text{mg prot}$ vs. $4.28 \pm 0.51 \text{ nmol}/\text{mg prot}$, $p < 0.05$).

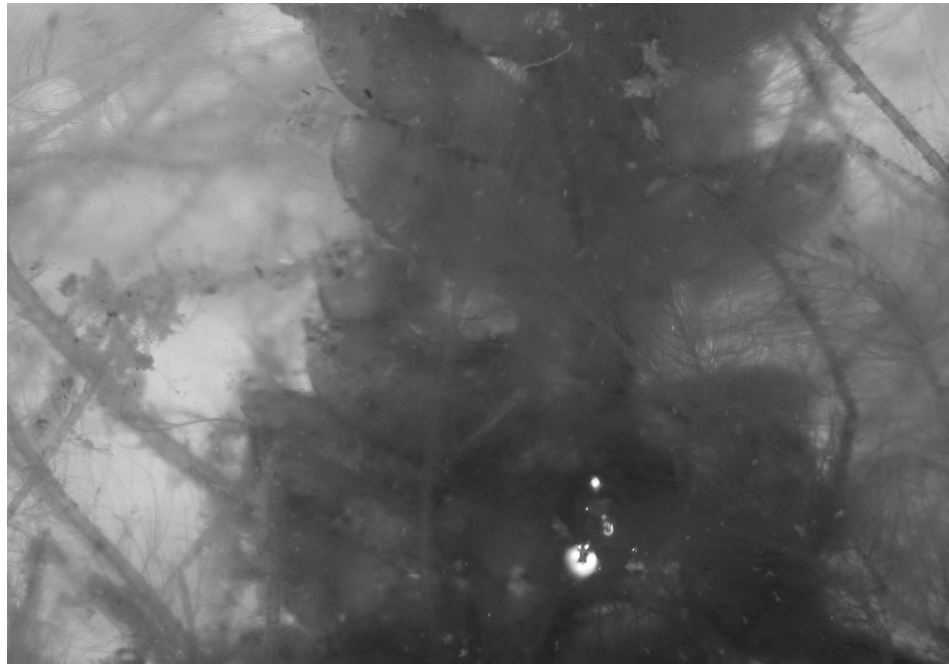

Figure 2: Example of a *Caulerpa taxifolia* frond epiphyted by invasive *Lophocladia lallemandii*. The picture shows an advanced stage of colonization with *L. lallemandii* heavily entangled with *C. taxifolia* frond.

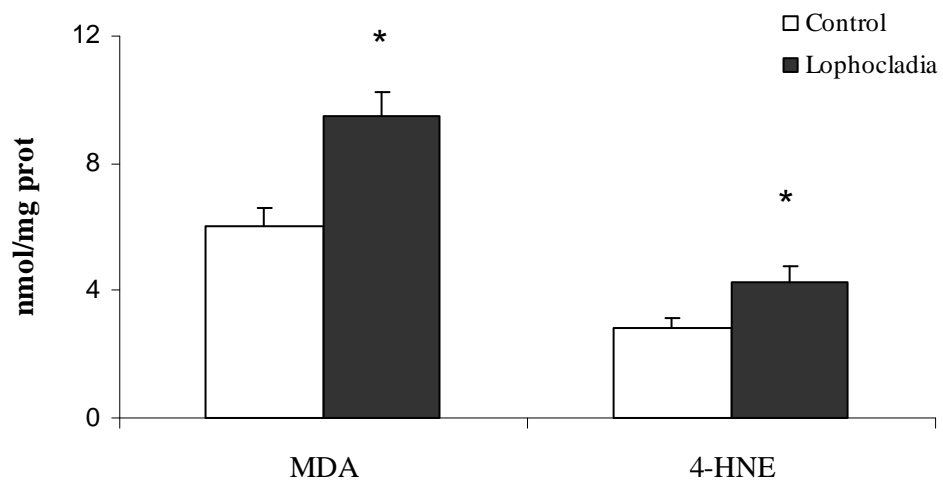

Figure 3: MDA and 4-HNE concentrations in *Caulerpa taxifolia* control and epiphyted by *Lophocladia lallemandii*. (*) Indicates significant differences between control and epiphyted *C. taxifolia* MDA and 4-HNE concentrations, (ANOVA, $p < 0.05$).

The antioxidant enzyme activities -catalase and SOD- were determined in fronds of *Caulerpa taxifolia* (Fig. 4). Catalase activity was increased significantly in the *Lophocladia* station 48% respect to the control station (47.1 ± 2.1 vs. 97.4 ± 8.8 K/mg

prot, $p < 0.05$). SOD activity was also significantly increased in the *Lophocladia* station 52% (8.58 ± 1.19 vs. 16.5 ± 1.4 pKat/mg prot, $p < 0.05$).

Caulerpa H₂O₂ production is presented in Figure 5. H₂O₂ production by *Caulerpa taxifolia* was significantly higher (52%) in the presence of *Lophocladia* when compared with the control station (3.44 ± 0.36 vs. 5.23 ± 0.80 pmol H₂O₂/min·mg prot, $p < 0.05$).

No significant differences were evidenced in the protein content between control and epiphytated areas (data not shown). Consequently, all the data describing changes in 4-HNE, MDA, antioxidant enzymes and H₂O₂ production could not be explained by a reduction in protein content in *Caulerpa* with epiphytes caused by competition of nutrients.

The activities of Catalase and SOD were determined in *Lophocladia lallemandii* (Table 1). No significant differences were evidenced in any of the studied enzymes between *Lophocladia* living over macroalgae and *Lophocladia* epiphytating *Caulerpa taxifolia*.

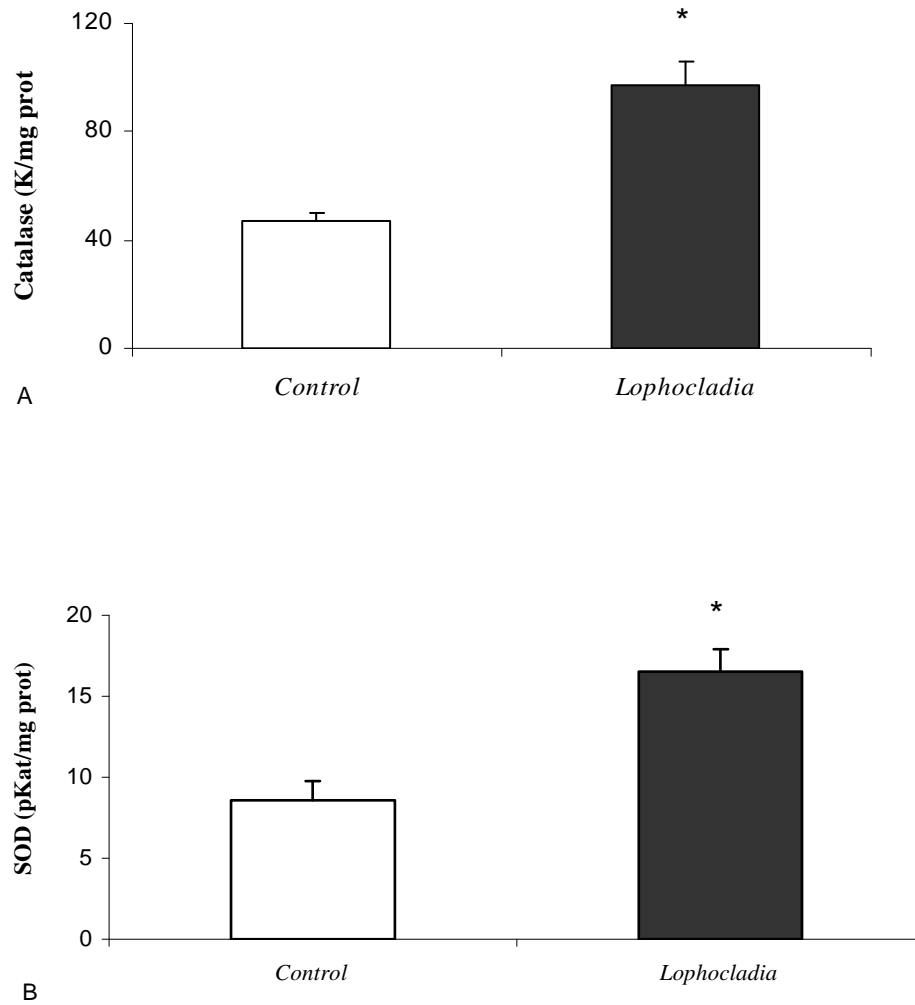

Figure 4: Catalase (A) and SOD (B) concentrations in *Caulerpa taxifolia* control and epiphyted by *Lophocladia lallemandii*. (*) Indicates significant differences between control and epiphyted *C. taxifolia* antioxidant enzymes concentrations, (ANOVA, $p < 0.05$).

Discussion

The presence of *C. taxifolia* in the Balearic Islands is reduced to Cala d'Or with an estimated extension of 20.000 m² approximately. *C. taxifolia* does not form a monoespecific macrophyte meadow since it usually grows in small patches over dead *P. oceanica* rhizomes rather than between live *P. oceanica* patches. The presence of additional invasive species such as *Lophocladia lallemandii* around the Balearic Islands (Patzner 1998) causes additional concerns. The co-occurrence of both species in the

same location and, further, the epiphytic growth of *L. lallemandi* over *C. taxifolia* provide an opportunity to investigate the nature of the interaction between these two alien species.

Chemical defenses are a well known mechanism in algae to avoid herbivory pressure and epiphytism (Paul and Hay 1986; Dumay et al. 2002; Erickson et al. 2006). It has been evidenced that algae produce higher concentrations of defensive compounds in areas subject to high herbivore pressure (Paul and Fenical 1986). Caulerpenyne secreted by the members of the genus *Caulerpa* presents toxic effects evidenced on various species (Parent-Massin et al. 1996; Brunelli et al. 2000; Barbier et al. 2001; Mozzachiodi et al. 2001).

Our results suggest that oxidative stress is involved in the mechanism by which two invasive species in the Mediterranean, *Caulerpa taxifolia* and *Lophocladia lallemandii*, interact at locations where they co-occur. The increased SOD and catalase enzymatic activities, and the increased lipid peroxidation shown by *C. taxifolia* when epiphytized by *L. lallemandii* suggest that the release of hydrogen peroxide could be involved in the response of *C. taxifolia* to epiphytism. Additionally, the caulerpenyne concentrations of *C. taxifolia* when not epiphytized by *L. lallemandii* were similar to the values obtained by Dumay (2002) in the same period of the year, but they increased significantly when epiphytized by *L. lallemandii*. Our results, therefore, suggest that the presence of *Lophocladia* over the fronds of *C. taxifolia* might induce a defensive mechanism to prevent epiphytism based on caulerpenyne. The interaction between these two invasive species is not symmetric for SOD and catalase activities because *L. lallemandii* is not affected by the presence of *C. taxifolia*, even as result of the increased concentration of caulerpenyne. The asymmetry of this interaction is consistent with the occurrence of *L. lallemandii* as an epiphyte of *C. taxifolia* and suggest that the overgrowth of *C. taxifolia* by *L. lallemandii* might drive a reduction of the abundance of *C. taxifolia* in the long-term.

The presence of competing organism are a possible source of oxidative stress and consequently could induce cellular damage. The existence of oxidative stress was determined by measuring markers of lipid peroxidation. Lipid peroxides, derived from polyunsaturated fatty acids, are unstable and decompose to form a complex series of compounds, such as MDA and 4-HNE. Both MDA and 4-HNE were increased in epiphyted *Caulerpa taxifolia*. It has been suggested that the release of H₂O₂ may function as a chemical defence against herbivores and epiphytes or as an allochemical in

direct competition with other algal species (Choo et al. 2004). The increased lipid peroxidation shown by *Caulerpa taxifolia* when epiphytized by *Lophocladia lallemandii* could be related to the increased H₂O₂ production to compete against *Lophocladia* rather than a marker of oxidative damage. In this situation of competence, the release of H₂O₂ could have no direct autotoxic effect (Collen and Pedersen 1996)

Cellular antioxidant status is used to evaluate the ability of organisms to resist an environmental stress. Our results show differences in some enzymatic activities such as catalase and SOD. SOD acts detoxifying superoxide anion to produce hydrogen peroxide. Over-production of superoxide radical in *C. taxifolia* that cannot be dismutated by SOD might damage polyunsaturated fatty acids of cell membrane (Imlay and Linn 1988; Gardner and Fridovich 1991). Catalase catalyses the production of oxygen and water from H₂O₂. Hydrogen peroxide production in an aerobic metabolism is of great importance because it might be transformed into such other harmful radicals as hydroxyl radical in the existence of some metals such as iron (Hippeli et al. 1999). The presence of higher catalase activity is corresponded with higher production of hydrogen peroxide to prevent epiphytism. Higher production of hydrogen peroxide might have been used by *C. taxifolia* to form some volatile halogenated compounds. Inhibition of epiphytes' growth on the surface of some algae species by these halogenated compounds has been stated in some reports (Collen et al. 1994; Collen and Pedersen 1996; Choo et al. 2004). It has been evidenced that the red algae *Corallina pilulifera* Postels and Ruprecht produces bromoform (CHBr₃) which has been shown to inhibit the growth of epiphytes on the surface (Ohsawa et al. 2001).

Conclusion

Lophocladia seems to be in advantage when interacting with *C. taxifolia* because there is no increase in antioxidant defenses when the two species interact. The antioxidant enzyme activities were similar when *Lophocladia* epiphytates over *C. taxifolia* and when living over macroalgae not containing caulerpenyne. In conclusion, our results suggest that the interaction between two invasive species of macroalgae in the Mediterranean, *Caulerpa taxifolia* and *Lophocladia lallemandii* is asymmetric in nature. *Lophocladia* can grow epiphytic over *Caulerpa taxifolia* which responds to this epiphyte by increasing the concentration of caulerpenyne and the SOD and catalase

activities resulting in an increased lipid peroxidation. Altogether, these evidences suggest that the epiphytism of *L. lallemandii* causes a stress situation in *C. taxifolia*. Further studies are necessary to elucidate if the proposed asymmetry of this interaction would result in a decrease of the abundance of *C. taxifolia* and a progression in *L. lallemandii* invasion.

Acknowledgements

The authors are grateful to Philip Amade for his technical assistance. This work was supported by the project “Expansión de *Caulerpa prolifera*, *C. taxifolia* y *C. racemosa* en el Mediterráneo: dinámica clonal, producción y destino de la producción” REN2002-00701/MAR and “Macroalgas marinas invasoras en las islas Baleares: Evaluación de riesgos y efectos en comunidades bentónicas” CTM2005-01434/MAR.

References

- Aebi, H.E., 1984. Catalase, Methods in Enzymatic Analysis, pp. 273-286.
- Amade, P., Lemee, R., 1998. Chemical defence of the Mediterranean alga *Caulerpa taxifolia*: variations in caulerpenyne production. *Aquat. Toxicol.* 43(4), 287-300.
- Asada, K., 1999. The water-water cycle in chloroplasts: Scavenging of active oxygens and dissipation of excess photons. *Annu. Rev. Plant. Physiol. Plant. Mol. Biol.* 50, 601-639.
- Asada, S., Fukuda, K., Oh, M., Hamanishi, C., Tanaka, S., 1999. Effect of hydrogen peroxide on the metabolism of articular chondrocytes. *Inflamm. Res.* 48(7), 399-403.
- Balata, D., Piazzini, L., Cinelli, F., 2004. A comparison among assemblages in areas invaded by *Caulerpa taxifolia* and *C. racemosa* on a subtidal Mediterranean rocky bottom. *Mar. Ecol. Prog. Ser.* 25(1), 1-13.
- Ballesteros, E., 2006. Mediterranean coralligenous assemblages: a synthesis of present knowledge. *Oceanog. Mar. Biol.* 44, 123-195.
- Barbier, P., Guise, S., Huitorel, P., Amade, P., Pesando, D., Briand, C., Peyrot, V., 2001. Caulerpenyne from *Caulerpa taxifolia* has an antiproliferative activity on

- tumor cell line SK-N-SH and modifies the microtubule network. *Life Sci.* 70(4), 415-429.
- BellanSantini, D., Arnaud, P.M., Bellan, G., Verlaque, M., 1996. The influence of the introduced tropical alga *Caulerpa taxifolia*, on the biodiversity of the Mediterranean marine biota. *J. Mar. Biol. Assoc. UK.* 76(1), 235-237.
- Boudouresque, C.F., Verlaque, M., 2002. Biological pollution in the Mediterranean Sea: invasive versus introduced macrophytes. *Mar. Pollut. Bull.* 44(1), 32-38.
- Boudouresque, C.F., Lemee, R., Mari, X., Meinesz, A., 1996. The invasive alga *Caulerpa taxifolia* is not a suitable diet for the sea urchin *Paracentrotus lividus*. *Aquat. Bot.* 53(3-4), 245-250.
- Brunelli, M., Garcia-Gil, M., Mozzachiodi, R., Roberto, M., Scuri, R., Traina, G., Zaccardi, M.L., 2000. Neurotoxic effects of caulerpenyne. *Prog. Neuropsychopharmacol. Biol. Psychiatry.* 24(6), 939-954.
- Cavas, L., Yurdakoc, K., 2005a. An investigation on the antioxidant status of the invasive alga *Caulerpa racemosa* var. *cylindracea* (Sonder) Verlaque, Huisman, et Boudouresque (Caulerpales, Chlorophyta). *J. Exp. Mar. Biol. Ecol.* 325(2), 189-200.
- Cavas, L., Yurdakoc, K., 2005b. A comparative study: Assessment of the antioxidant system in the invasive green alga *Caulerpa racemosa* and some macrophytes from the Mediterranean. *J. Exp. Mar. Biol. Ecol.* 321(1), 35-41.
- Ceccherelli, G., Campo, D., 2002. Different effects of *Caulerpa racemosa* on two co-occurring seagrasses in the Mediterranean. *Bot. Mar.* 45(1), 71-76.
- Ceccherelli, G., Piazzini, L., Balata, D., 2002. Spread of introduced *Caulerpa* species in macroalgal habitats. *J. Exp. Mar. Biol. Ecol.* 280(1-2), 1-11.
- Collen, J., Pedersen, M., 1996. Production, scavenging and toxicity of hydrogen peroxide in the green seaweed *Ulva rigida*. *Eur. J. Phycol.* 31(3), 265-271.
- Collen, J., Ekdahl, A., Abrahamsson, K., Pedersen, M., 1994. The Involvement of Hydrogen-Peroxide in the Production of Volatile Halogenated Compounds by *Meristiella gelidium*. *Phytochemistry* 36(5), 1197-1202.
- Choo, K.S., Snoeijs, P., Pedersen, M., 2004. Oxidative stress tolerance in the filamentous green algae *Cladophora glomerata* and *Enteromorpha ahlneriana*. *J. Exp. Mar. Biol. Ecol.* 298(1), 111-123.

- Devillele, X., Verlaque, M., 1995. Changes and Degradation in a *Posidonia oceanica* Bed Invaded by the Introduced Tropical Alga *Caulerpa taxifolia* in the North-Western Mediterranean. *Bot. Mar.* 38(1), 79-87.
- Dumay, O., Pergent, G., Pergent-Martini, C., Amade, P., 2002. Variations in caulerpenyne contents in *Caulerpa taxifolia* and *Caulerpa racemosa*. *J. Chem. Ecol.* 28(2), 343-352.
- Elias, S.J., Arner, E.S., Zhong, L., Holmgren, A., 1999. In: Packer L (ed) *Methods in Enzymatic Analysis. Oxidants and Antioxidants*. Academic Press, California vol. 300 pp 226-239.
- Erickson, A.A., Paul, V.J., Van Alstyne, K.L., Kwiatkowski, L.M., 2006. Palatability of macroalgae that use different types of chemical defenses. *J. Chem. Ecol.* 32(9), 1883-1895.
- Ferrer, E., Garreta, A.G., Ribera, M.A., 1997. Effect of *Caulerpa taxifolia* on the productivity of two Mediterranean macrophytes. *Mar. Ecol.-Prog. Ser.* 149(1-3), 279-287.
- Gardner, P.R., Fridovich, I., 1991. Superoxide Sensitivity of the *Escherichia coli* 6-Phosphogluconate Dehydratase. *J. Biol. Chem.* 266(3), 1478-1483.
- Gross, H., Goeger, D.E., Hills, P., Mooberry, S.L., Ballantine, D.L., Murray, T.F., Valeriote, F.A., Gerwick, W.H., 2006. Lophocladines, bioactive alkaloids from the red alga *Lophocladia* sp. *J. Nat. Prod.* 69(4), 640-644.
- Hippeli, S., Heiser, I., Elstner, E.F., 1999. Activated oxygen and free oxygen radicals in pathology: New insights and analogies between animals and plants. *Plant Physiol. Bioch.* 37(3), 167-178.
- Imlay, J.A., Linn, S., 1988. DNA Damage and Oxygen Radical Toxicity. *Science* 240(4857), 1302-1309.
- Jaubert, J.M., Chisholm, J.R.M., Minghelli-Roman, A., Marchioretto, M., Morrow, J.H., Ripley, H.T., 2003. Re-evaluation of the extent of *Caulerpa taxifolia* development in the northern Mediterranean using airborne spectrographic sensing. *Mar. Ecol.-Prog. Ser.* 26(3), 75-82.
- Jousson, O., Pawlowski, J., Zaninetti, L., Meinesz, A., Boudouresque, C.F., 1998. Molecular evidence for the aquarium origin of the green alga *Caulerpa taxifolia* introduced to the Mediterranean Sea. *Mar. Ecol.-Prog. Ser.* 172(2), 75-280.
- Livingstone, D.R., 2001. Contaminant-stimulated reactive oxygen species production and oxidative damage in aquatic organisms. *Mar Pollut Bull* 42(8), 656-666.

- MacDougall, A.S., Turkington, R., 2005. Are invasive species the drivers or passengers of change in degraded ecosystems? *Ecology* 86(1), 42-55.
- Mack, R.N., Simberloff, D., Lonsdale, W.M., Evans, H., Clout, M., Bazzaz, F.A., 2000. Biotic invasions: Causes, epidemiology, global consequences, and control. *Ecol. Appl.* 10(3), 689-710.
- McCord, J.M., Fridovich, I., 1969. Superoxide dismutase. An enzymic function for erythrocyte hemoglobin (hemocyanin). *J Biol Chem* 244(22), 6049-6055.
- Meinesz, A., Devaugelas, J., Hesse, B., Mari, X., 1993. Spread of the Introduced Tropical Green-Alga *Caulerpa taxifolia* in Northern Mediterranean Waters. *J. Appl. Phycol.* 5(2), 141-147.
- Mozzachiodi, R., Scuri, R., Roberto, M., Brunelli, M., 2001. Caulerpenyne, a toxin from the seaweed *Caulerpa taxifolia*, depresses afterhyperpolarization in invertebrate neurons. *Neuroscience* 107(3), 519-526.
- Ohsawa, N., Tsujita, M., Morikawa, S., Itoh, N., 2001. Purification and characterization of a monohalomethane-producing enzyme S-adenosyl-L-methionine: Halide ion methyltransferase from a marine microalga, *Pavlova pinguis*. *Biosci. Biotech. Bioch.* 65(11), 2397-2404.
- Parent-Massin, D., Fournier, V., Amade, P., Lemee, R., Durand-Clement, M., Delescluse, C., Pesando, D., 1996. Evaluation of the toxicological risk to humans of caulerpenyne using human hematopoietic progenitors, melanocytes, and keratinocytes in culture. *J. Toxicol. Environ. Health* 47(1), 47-59.
- Patzner, R., 1998. The invasion of *Lophocladia* (Rhodomelaceae, Lophotiales) at the northern coast of Ibiza (Western Mediterranean Sea). *Boll. Soc. Hist. Nat. I. Balears* 41, 75-80.
- Paul, V.J., Fenical, W., 1986. Chemical defense in tropical green algae, order Cauleriales. *Mar Ecol Prog Ser* 34(1), 57-169.
- Paul, V.J., Hay, M.E., 1986. Seaweed Susceptibility to Herbivory - Chemical and Morphological Correlates. *Mar. Ecol.-Prog. Ser.* 33(3), 255-264.
- Piazzini, L., Balata, D., Ceccherelli, G., Cinelli, F., 2001. Comparative study of the growth of the two co-occurring introduced green algae *Caulerpa taxifolia* and *Caulerpa racemosa* along the Tuscan coast (Italy, western Mediterranean). *Cryptogamie Algol.* 22(4), 459-466.
- Sakai, A.K., Allendorf, F.W., Holt, J.S., Lodge, D.M., Molofsky, J., With, K.A., Baughman, S., Cabin, R.J., Cohen, J.E., Ellstrand, N.C., McCauley, D.E.,

- O'Neil, P., Parker, I.M., Thompson, J.N., Weller, S.G., 2001. The population biology of invasive species. *Annu. Rev. Ecol. Syst.* 32, 305-332.
- Shi, H., Sui, Y., Wang, X., Luo, Y., Ji, L., 2005. Hydroxyl radical production and oxidative damage induced by cadmium and naphthalene in liver of *Carassius auratus*. *Comp. Biochem. Physiol. C Toxicol. Pharmacol.* 140(1), 115-121.
- Sureda, A., Box, A., Ensenat, M., Alou, E., Tauler, P., Deudero, S., Pons, A., 2006. Enzymatic antioxidant response of a labrid fish (*Coris julis*) liver to environmental caulerpenyne. *Comp. Biochem. Physiol. C Toxicol. Pharmacol.* 144(2), 191-196.
- Verlaque, M., Fritayre, P., 1994. Mediterranean Algal Communities Are Changing in the Face of the Invasive Alga *Caulerpa taxifolia* (Vahl) C Agardh. *Oceanol. Acta* 17(6), 659-672.

6.6 Resumen de efectos de caulerpenina y defensas antioxidantes

Resumen del estudio “Seasonality of caulerpenyne contents in the native *C. prolifera* and the invasive *C. taxifolia* and *C. racemosa* var *cylindracea* in the Western Mediterranean”

- La caulerpenina es un metabolito secundario de defensa de *Caulerpa* spp. contra el herbivorismo y el epifitismo (Doty 1966; Maiti et al. 1978; Schwede et al. 1987; Jung et al. 2002). La concentración de caulerpenina ha podido ser detectada y medida en las tres especies de *Caulerpa* estimándose su concentración en base a un patrón realizado con caulerpenina pura.
- Las tres especies de *Caulerpa* presentan diferente grado de toxicidad:
 - *Caulerpa prolifera*, presenta las mayores concentraciones de caulerpenina. Los estolones presentan mayor concentración de caulerpenina ($72.92 \pm 6.44 \mu\text{g CYN} / \text{mg alga}$) que los frondes ($46.35 \pm 2.51 \mu\text{g CYN} / \text{mg alga}$).
 - *Caulerpa taxifolia* presenta una concentración de caulerpenina intermedia y sus frondes presentan mayor concentración de caulerpenina ($54.70 \pm 3.12 \mu\text{g CYN} / \text{mg alga}$) que sus estolones ($12.73 \pm 0.37 \mu\text{g CYN} / \text{mg alga}$).
 - *Caulerpa racemosa* var. *cylindracea* presenta la concentración de caulerpenina menor y sin diferencias entre frondes ($4.31 \pm 0.79 \mu\text{g CYN} / \text{mg alga}$) y estolones ($2.91 \pm 1.30 \mu\text{g CYN} / \text{mg alga}$).
- La concentración de caulerpenina en *Caulerpa prolifera* está positivamente correlacionada con la presencia del consumidor directo *Ascobulla fragilis*. Al aumentar la presencia de este opistobranquio, *C. prolifera* aumenta su toxicidad para reducir su consumo.

- La temperatura es la principal variable evaluada responsable de las concentraciones de caulerpenina en las invasoras *Caulerpa taxifolia* y *C. racemosa* var. *cylindracea*.
- La caulerpenina puede estar relacionado con el éxito de expansión de caulerpales invasoras, pero los resultados obtenidos muestran que otras variables como pueden ser sus tasas de crecimiento o dispersión (entre otras) han de contribuir a su capacidad de invasión. *C. racemosa* var. *cylindracea* con la menor presencia de caulerpenina es la que presenta mayor expansión y capacidad de invasión actualmente en las Baleares.

Resumen del estudio “Enzymatic antioxidant response of a labrid fish (*Coris julis*) liver to environmental caulerpenyne”

- *Coris julis* presenta mayor actividad GPx y GST en el hígado en las estaciones donde encontramos *Caulerpa* (GPx 14.4±0.9 nKat / mg prot en *Caulerpa taxifolia* y 15.7 nKat / mg prot en *Caulerpa prolifera* y GST 371±34 nKat / mg prot en *Caulerpa taxifolia* y 391±28 nKat / mg prot en *Caulerpa prolifera*) respecto a *Posidonia* (GPx 11.2±1.1 nKat / mg prot y GST 232±24 nkat / mg prot). Este aumento de los enzimas antioxidantes es debido a un incremento en la tasa de biotransformación de la CYN o reparación de los componentes celulares dañados por las ROS como por proteínas oxidadas. La actividad GST requiere GSH como sustrato oxidándolo a GSSG. El mantenimiento del ratio GSH/GSSG usado como marcador del estado redox celular, es necesario para un correcto funcionamiento celular. La GR encargada de reducir GSSG a GSH, se ve incrementada en el hígado de *C. julis*, reflejando que el metabolismo celular recicla activamente GSSG.
- El aumento de las actividades GPX y GST y el mantenimiento de la actividad CAT en las estaciones con presencia de caulerpales indica la mayor detoxificación de hidroperóxidos lipídicos. La detoxificación de H₂O₂ tiene

menor importancia y no se pueden establecer diferencias entre las zonas invadidas por *Caulerpa* spp. y *P. oceanica*.

- *Coris julis* a pesar de tener un aumento en las defensas antioxidantes sigue siendo muy abundante en las praderas de *Caulerpa* spp. El MDA no muestra diferencias entre las zonas de *Posidonia oceanica* y las zonas de *Caulerpa* spp., por lo que podemos concluir que esta especie aumenta de una manera eficiente sus defensas antioxidantes, evitando el daño oxidativo asociado a la presencia de CYN.

Resumen del estudio “Reciprocal effects of caulerpenyne and intense herbivorism on the antioxidant response of *Bittium reticulatum* and *Caulerpa taxifolia*”

- *Bittium reticulatum* como hemos puesto de manifiesto en los experimentos, en acuarios (observaciones visuales) y en el campo (análisis de isótopos estables) se alimenta de los frondes de *C. taxifolia*.
- *Bittium reticulatum* incrementa las actividades GPx y GST al introducir los ejemplares en acuarios con *Caulerpa taxifolia* (GPx 13.9 ± 0.8 nKat / mg prot y GST 278 ± 24 nKat / mg prot) respecto acuarios con *Posidonia oceanica* (GPx 10.8 ± 0.8 nKat / mg prot y GST 211 ± 20 nKat / mg prot) . No se observan diferencias significativas en la actividad CAT comparando ejemplares de acuarios con *C. taxifolia* y *P. oceanica*. Las elevadas actividades GPx y GST indican que la CYN de los acuarios provocan un descenso de la GSH en las células provocando una mayor actividad GR para reciclar el GSSG y mantener el ratio GSH/GSSG.
- Este gasterópodo de estrategia detritívora/herbívora es abundante en las praderas de *Caulerpa*. Como reflejan los resultados obtenidos, no se aprecia daño en la membrana lipídica (MDA no presenta diferencias significativas) por lo tanto esta especie está aclimatada al sustrato de las praderas de caulerpales.

- *Caulerpa taxifolia* al estar sometida a presión de herbívoros sufre daño en sus estructuras (frondes y estolones), aumentando la producción de ROS y en consecuencia se induce un aumento de las defensas antioxidantes para evitar y reparar el daño oxidativo inducido por la herbivoría. *Bittium reticulatum* al alimentarse del alga, probablemente, produce cascadas oxidativas al verse expuestas moléculas susceptibles de sufrir oxidación y/o liberar enzimas con actividades pro-oxidativas. El incremento de la respuesta antioxidante de *C. taxifolia* al introducir el herbívoro *B. reticulatum* se expresa en:
 - CAT aumenta de 10.3 ± 0.7 K / mg prot a 17.9 ± 1.3 K /mg prot.
 - GR aumenta de 4.28 ± 0.37 nKat / mg prot a 5.40 nKat / mg prot.
 - GPx mantiene valores similares 1.85 ± 0.19 nKat / mg prot sin herbívoros y 1.79 nKat / mg prot con herbívoros.
- El aumento de ROS en *Caulerpa taxifolia* puede ser una estrategia junto a un aumento en la producción de CYN para reducir la presión sobre los tejidos de *B. reticulatum*. Cavas y Yurdakoc (2005) reflejan que el estatus antioxidante de *C. racemosa* puede estar influenciada por el epifitismo. Una mayor actividad de CAT se corresponde con una mayor producción de peróxido de hidrógeno para evitar el epifitismo, o como en el caso estudiado, el herbivorismo.
- La presencia de herbívoros implica una respuesta de *Caulerpa taxifolia* expresada en un incremento de CYN. Su concentración pasa de 3.33 ± 0.43 mg CYN / g alga a 6.28 ± 0.61 mg CYN / g alga con la presencia de *Bittium reticulatum*. El incremento de CYN en *Caulerpa* está dirigido a reducir su presión herbívora reduciendo su palatabilidad, pero parece no ser efectivo sobre *Bittium reticulatum* que no sufre daño oxidativo.

Resumen del estudio “Antioxidant response and caulerpenyne production of the alien *Caulerpa taxifolia* (Vahl) C. Agardh epiphytized by the invasive alga *Lophocladia lallemandii* (Montagne)”

- *Lophocladia lallemandii* es capaz de epifitar a *Caulerpa taxifolia* dañándola y activando las respuestas contra el epifitismo.
- La respuesta de *Caulerpa taxifolia* al verse sometida al epifitismo de *Lophocladia lallemandii* es un aumento significativo en los enzimas antioxidantes como la SOD y CAT:
 - SOD pasa de 8.58 ± 1.19 a 16.6 ± 1.4 pKat / mg prot.
 - CAT pasa de 47.1 ± 2.1 a 97.4 ± 8.8 K / mg prot.
- *Caulerpa taxifolia* aumenta significativamente su concentración de CYN como respuesta al epifitismo (incrementa concentración $1.68 \mu\text{g CYN} / \text{mg}$ de alga). El uso de CYN como mecanismo defensivo contra el epifitismo en *C. racemosa* ha sido previamente descrito por Cavas (2005) y su función es reducir la presión de epífitos.
- A pesar de la activación tanto de las defensas antioxidantes como del incremento de la concentración de caulerpenina, *Caulerpa taxifolia* muestra peroxidación lipídica, y por consiguiente daño oxidativo.
- La interacción entre las dos especies invasoras no es similar en lo referente a las actividades enzimáticas. *Lophocladia lallemandii* no se ve afectada por la presencia de *Caulerpa taxifolia* ni por el aumento de la concentración de CYN. Esta asimetría en la respuesta antioxidante sugiere que *L. lallemandii* es capaz de dañar a *Caulerpa taxifolia*.

Capítulo 7

Recapitulación de resultados

Conclusiones de la presente tesis doctoral

- Las especies de *Caulerpa* con carácter invasor, *Caulerpa racemosa* var. *cylindracea* y *Caulerpa taxifolia*, presentan diferencias en la estructura y alteración del hábitat original respecto a las especies Mediterráneas *Caulerpa prolifera* y *Posidonia oceanica*. Estas diferencias se dan a nivel de:
 - Estacionalidad y crecimiento. Las tres caulerpales presentan entre ellas diferencias en crecimiento (referido a incremento de biomasa). Estas diferencias son mayores al compararlas con el lento crecimiento de *Posidonia oceanica*.
 - Biomasa de caulerpales. Las biomásas algales presentan diferencias entre especies de *Caulerpa*. Por orden son mayores en *Caulerpa prolifera* que en *Caulerpa taxifolia* y que en *C. racemosa* var. *cylindracea* exceptuando los periodos de máxima biomasa donde esta última presenta mayor biomasa que *C. taxifolia*.
 - Tiempo de colonización del sustrato. La zona colonizada por *Caulerpa prolifera* está más modificada respecto a la pradera original de *Posidonia oceanica*, ya que el tiempo de colonización es mucho mayor que para las otras caulerpales invasoras. Esto se refleja, por ejemplo, en la granulometría de cada hábitat, (*C. prolifera* presenta arenas muy finas) y en las diferencias en la contribución de los diferentes componentes estructurales de *Posidonia oceanica* en las caulerpales, más modificado para *C. prolifera*.
 - Toxicidad. Las tres caulerpales estudiadas presentan diferencias en su concentración de caulerpenina. *Caulerpa prolifera* es la que presenta mayor concentración, seguida por *C. taxifolia* y finalmente *C. racemosa* var. *cylindracea*.
- Las especies dominantes para los moluscos, decápodos y poliquetos en cada una de las praderas estudiadas son:

- En *Caulerpa prolifera* los moluscos *Ascobulla fragilis*, *Bittium reticulatum*, *Cerithium vulgatum*, *Loripes lacteus*, *Glans trapezia*, *Venerupis aurea*, los decápodos *Athanas nitescens*, *Calcinus tubularis*, *Xantho pilipes*, *Cestopagurus timidus*, *Sirpus zariquieyi*, *Upogebia pusilla*, *Upogebia mediterranea*, *Processa* sp., *Galathea squamifera*, *Liocarcinus arcuatus*, *Galathea bolivari* y los poliquetos *Neanthes agulhana*, *Sphaerosyllis austriaca*, *Hyalinoecia bilineata*, *Lumbrineris latreilli*, *Lumbrineris gracilis*, *Arabella iricolor*, *Polyopthalmus pictus*, *Sphaerosyllis pirifera*, *Pelogenia arenosa*, *Pectinaria (Lagis) koremi*, *Eunice vittata*, *Nematonereis unicornis*, *Pholoe inornata*, *Exogone (exogone) rostrata*, *Glycera* sp., *Lysidice ninetta*, *Platynereis dumerilii*.

- En *Caulerpa taxifolia* los moluscos *Ascobulla fragilis*, *Cerithium vulgatum*, *Tricolia pullus*, *Bittium reticulatum*, *Bittium latreilli*, *Rissoina bruguieri*, *Glans trapezia*, *Ctena decussata*, *Loripes lacteus*, *Arca noae*, *Arcopagia balaustina*, *Limaria hians*, *Venus verrucosa*, *Chama gryphoides*, *Lucinella divaricata*, *Parvicardium exiguum*, *Venus casina*, los decápodos *Athanas nitescens*, *Calcinus tubularis*, *Ebalia edwardsii*, *Galathea bolivari*, *Alpheus dentipes*, *Cestopagurus timidus*, *Achaeus cranchii*, *Xantho pilipes*, *Sirpus zariquieyi*, *Processa* sp., *Ilia nucleus*, *Pisa muscosa*, *Alpheus macrocheles*, *Automate branchialis*, *Pisa tetraodon* y los poliquetos *Hyalinoecia bilineata*, *Neanthes agulhana*, *Lumbrineris latreilli*, *Nematonereis unicornis*, *Polyopthalmus pictus*, *Pelogenia arenosa*, *Harmothoe spinifera*, *Lysidice ninetta*, *Eunice vittata*, *Sphaerosyllis pirifera*, *Sthenelais boa*, *Platynereis dumerilii*, *Pontogenia chrysocoma*, *Lumbrineris gracilis*, *Sphaerosyllis austriaca*, *Syllis garciai*, *Pholoe inornata*, *Lumbrineris impatiens*, *Lumbrineropsis paradoxa* y *Pherusa eruca*.

- En *Caulerpa racemosa* var. *cylindracea* los moluscos *Bittium reticulatum*, *Alvania cimex*, *Ascobulla fragilis*, *Nassarius incrassatus*, *Smaragdia viridis*, *Rissoina bruguieri*, *Cerithium vulgatum*, *Gibbula ardens*, *Glans trapezia*, *Ctena decussata*, *Loripes lacteus*, *Venerupis aurea*, *Venus verrucosa*, *Musculus costulatus*, los decápodos *Athanas nitescens*, *Galathea bolivari*,

Cestopagurus timidus, *Upogebia mediterranea*, *Xantho pilipes*, *Calcinus tubularis*, *Galathea squamifera*, *Alpheus dentipes*, *Sirpus zariquieyi* y los poliquetos *Neanthes agulhana*, *Pelogenia arenosa*, *Polyopthalmus pictus*, *Lumbrineris latreilli*, *Harmothoe spinifera*, *Arabella iricolor*, *Sthenelais boa*, *Syllis garciai*, *Pontogenia chrysocoma*, *Pherusa eruca*, *Pholoe inornata*, *Platynereis dumerilii*, *Lumbrineris gracilis*, *Pectinaria (Lagis) koremi*, *Hyalinoecia bilineata*, *Neanthes caudata*, *Sphaerosyllis pirifera*, *Spirobranchus polytrema*, *Haplosyllis spongicola*, *Malmgreniella lunulata*, *Pectinaria (Amphictene) auricoma* y *Eunice vittata*.

- En *Posidonia oceanica* los molusc *Smaragdia viridis*, *Tricolia pullus*, *Bittium reticulatum*, *Rissoina bruguieri*, *Payraudeautia intricata*, *Glans trapezia*, *Arca noae*, *Striarca lactea*, *Loripes lacteus*, *Limaria hians*, *Chama gryphoides*, *Ctena decussata*, *Musculus costulatus*, *Modiolus barbatus*, *Venerupis aurea*, *Venus verrucosa*, los decápodos *Athanas nitescens*, *Calcinus tubularis*, *Galathea bolivari*, *Pisa muscosa*, *Alpheus dentipes*, *Galathea cenarroi*, *Alpheus macrocheles*, *Achaeus cranchii*, *Ilia nucleus*, *Pisidia longimana*, *Automate branchialis*, *Cestopagurus timidus*, *Dromia personata*, *Ebalia edwardsii*, *Macropodia longirostris*, *Pagurus anachoretus*, *Pilumnus hirtellus*, *Xantho incisus granulicarpus*, *Xantho pilipes* y los poliquetos *Nematonereis unicornis*, *Hyalinoecia bilineata*, *Neanthes agulhana*, *Lysidice ninetta*, *Eunice vittata*, *Lumbrineris gracilis*, *Polyopthalmus pictus*, *Lumbrineris latreilli*, *Platynereis dumerilii*, *Hydroides nigra*, *Pterocirrus macroceros*, *Syllis variegata*, *Arabella iricolor*, *Chrysopetalum debile*, *Spirobranchus polytrema*, *Phyllodoce (Anaitides) mucosa*, *Pelogenia arenosa*, *Neanthes caudata*, *Syllis gerlachi*, *Sthenelais boa*, *Pherusa eruca*, *Glycera* sp. y *Haplosyllis spongicola*.
- Las tres caulerpales estudiadas comparten gran cantidad de especies con *Posidonia oceanica*, tanto de moluscos, decápodos y poliquetos. La mayoría de especies encontradas son propias de fondos blandos de la zona infralitoral. La principal diferencia entre los cuatro hábitats estudiados se basan en las diferencias en abundancia de las especies coincidentes.

- La comunidad de invertebrados de *Posidonia oceanica* está compuesta en general por especies coincidentes con otros hábitats y con poco grado de especialización. Algunas de estas especies, compartidas con otros hábitats de fondos blandos y/o duros, se ven favorecidas por la presencia de las tres caulerpales estudiadas donde aumentan sus abundancias. Este es el caso de los invertebrados:
 - Los moluscos *Bittium reticulatum* (ubicua en fondos litorales), *Loripes lacteus* (común en fondos blandos) y *Glans trapezia* (frecuente en fondos rocosos y sobre rizomas de *Posidonia oceanica*).
 - Los decápodos *Athanas nitescens* (especies excavadora frecuente en fondos blandos y sustrato rocoso), *Calcinus tubularis* (común en *Posidonia* y en sustrato rocoso), *Cestopagurus timidus* (presente en *Posidonia* y en sustrato rocoso) y *Xantho pilipes* (descrito como frecuente debajo de rocas hasta los 33 metros).
 - Los poliquetos *Neanthes agulhana* (especie común en comunidades infralitorales con preferencia por aguas tranquilas), *Polyopthalmus pictus* (especie muy común en comunidades de algas fotófilas y fondos blandos en Baleares) y *Lumbrineris latreilli* (común en zona infralitoral con preferencia por hábitats de arenas finas aunque no exclusivo).
- Las *Caulerpa* invasoras, *C. racemosa* var. *cylindracea* y *C. taxifolia*, no forman en ninguno de los escenarios estudiados praderas monoespecíficas, y las áreas colonizadas están en contacto directo con praderas de *Posidonia oceanica* y/o fondos arenosos. Por consiguiente, en las zonas con *Caulerpa* invasoras nos podemos encontrar con una confluencia y desplazamientos de especies de hábitats próximos y adyacentes, el efecto “borde de pradera” que favorece un incremento de abundancias y diversidad de invertebrados y el hábitat generado por la mata muerta de *Posidonia oceanica*, rico en abundancias y en especies de invertebrados.
- *Caulerpa prolifera*, especie establecida en el Mediterráneo, presenta una comunidad de invertebrados más diferenciada de *Posidonia oceanica*, destacándose la presencia de consumidores especializados en *Caulerpa* (*Ascobulla fragilis*) y organismos

detritívoros (comunidad de poliquetos (*Polyopthalmus pictus*), moluscos (*Loripes lacteus*) y decápodos (*Upogebia* spp.) favorecidos por la capacidad de *C. prolifera* de retener partículas y el consiguiente enriquecimiento de materia orgánica.

- Los resultados obtenidos muestran para el filum moluscos en *Caulerpa prolifera* y *C. taxifolia* (en concreto para el grupo de los filtradores) y para los poliquetos de *C. taxifolia*, un efecto negativo del incremento de biomasa. En el caso de *C. racemosa* se ha encontrado un efecto positivo del incremento de biomasa sobre los poliquetos (abundancias y diversidad), moluscos (diversidad). En los decápodos el efecto de la biomasa de *Caulerpa* no ha sido demostrado. El muestreo dirigido a la infauna en *Caulerpa racemosa* var. *cylindracea*, conlleva que las especies móviles, más asociadas a la biomasa de *Caulerpa*, no hayan sido muestreadas totalmente. A pesar de ello las máximas abundancias y diversidades de decápodos se encontraron en *C. racemosa* var. *cylindracea* durante el periodo de máxima biomasa.
- Los resultados obtenidos especialmente en *Caulerpa racemosa* var. *cylindracea* muestran un incremento de abundancias y de diversidad de invertebrados acorde con las máximas biomásas de *Caulerpa*. El hecho *C. racemosa* var. *cylindracea* sea la especie menos protegida químicamente, con menor concentración de caulerpenina, evita que afecte negativamente a los organismos y que el entramado de frondes y estolones que forma sobre el sustrato, que puede alcanzar varios centímetros de grosor, provea a los invertebrados de un hábitat en el que encuentra alimento y especialmente refugio contra los predadores. El efecto barrera contra los peces ha sido ya demostrado con la invasora *Caulerpa taxifolia*. La barrera formada por los frondes y estolones, especialmente durante el final de verano y comienzo de otoño, evita que los peces puedan acceder a los invertebrados que encuentran allí refugio.
- En la presente tesis doctoral se ha estudiado la aplicabilidad y desarrollo de técnicas de medida de respuesta antioxidante en situaciones de organismos expuestos a caulerpenina. Ésta toxina presenta unas características estructurales que hacen que sea sustrato del citocromo P450, produciéndose la formación de reactivos intermediarios que inducen peroxidación lipídica

- Parte de este trabajo ha consistido en la puesta a punto de técnicas de medidas de estrés oxidativo para organismos tan dispares fisiológica y filogenéticamente como peces, moluscos y algas. La aplicación de estas técnicas nos permite establecer causa/efecto de la presencia de invasoras sobre la comunidad. En la presente tesis se han desarrollado tres escenarios, dos situaciones sin que la presencia de algas invasora cause daño al organismo bentónico y un caso de interacción de especies invasoras, en el cual una de ellas se ve dañada, dato que concuerda con la reducción de su presencia en la zona de estudio. Las conclusiones obtenidas son:
 - Se ha demostrado que el gasterópodo *Bittium reticulatum*, especie generalista, es capaz de adaptarse al nuevo hábitat generado por las *Caulerpa* e incluso ingerir en mayor o menor medida *Caulerpa*. Esta especie como muestran los resultados de faunística presenta mayores abundancias en las zonas invadidas por *Caulerpa* que en *Posidonia oceanica* ratificando por los resultados bioquímicos.
 - El osteíctio *Coris julis*, a pesar de no ingerir *Caulerpa* activamente está afectado por la caulerpenina ambiental y la caulerpenina ingerida indirectamente (predación de invertebrados consumidores de *Caulerpa*). A pesar de ello, esta especie descrita como común en praderas de *Caulerpa* no sufre daño oxidativo por lo que puede habitar en praderas de *Caulerpa* spp. sin sufrir daño asociado a la toxicidad del alga.
 - La invasora *Caulerpa taxifolia* al ser epifitada por *Lophocladia lallemandii* sufre daño oxidativo. Este efecto negativo puede ser causa de la no expansión de *C. taxifolia* y la reducción de las áreas colonizadas observado durante el desarrollo de los estudios en Cala d'Or desde 2003 hasta el 2008.
- Las especies animales estudiadas, *Bittium reticulatum* y *Coris julis*, demuestran una gran capacidad de adaptación a entornos cambiantes. Se trata de especies frecuentes en la zona infralitoral mediterránea y como demuestran los resultados no se ven afectadas negativamente por la presencia de *Caulerpa taxifolia* ni por sus metabolitos secundarios como la caulerpenina tal y como demuestran las medidas de peroxidación lipídica. Estos organismos exhiben una elevada capacidad de aumentar

sus mecanismos detoxificadores primarios, como son los enzimas antioxidantes. Ambos organismos muestran un efecto similar ante la caulerpenina, que incrementa la generación de hidróxidos lipídicos que ambos eliminan mediante los enzimas GST y GPX.

- El desarrollo de estas metodologías es muy novedoso y una próxima etapa en la investigación sería la aplicación de los biomarcadores de estrés oxidativo en aquellas especies que han visto disminuidas sus abundancias por la presencia de las caulerpales. Un futuro estudio podría desarrollarse con alguna especie de moluscos como *Rissoa*, *Arca noae*, decápodos como *Pisa muscosa*, *Alpheus macrocheles* o en poliquetos como *Nematonereis unicornis*. Es también de gran interés el desarrollo y aplicación de biomarcadores en especies de peces muy especializadas como *Signathus typhle* o *Symphodus rostratus* y realizar experimentos para evaluar el efecto barrera asociado a la presencia de estas algas invasoras sobre las especies más especializadas en alimentarse en *Posidonia oceanica*.
- El uso de biomarcadores, actividad de enzimas antioxidantes y niveles de peroxidación lipídica, han demostrado su utilidad como herramienta para analizar los efectos de *Caulerpa* sobre las comunidades bentónicas e ícticas. Mediante la aplicación de estas técnicas podemos complementar las metodologías clásicas basadas principalmente en la abundancia y en la diversidad de especies con una medida fisiológica. Todo ello nos ayuda a establecer una relación causa/efecto del aumento o disminución de una especie por la presencia de *C. taxifolia*.
- El uso de marcadores de estrés oxidativo y de peroxidación lipídica han demostrado su aplicabilidad para analizar interacciones entre algas invasoras como demuestra los dos estudios realizados con *Caulerpa taxifolia*.
- Una de las principales causas postuladas para explicar la expansión de las caulerpales invasoras a lo largo de la cuenca mediterránea ha sido hasta hace poco la presencia de caulerpenina en el alga. Los resultados obtenidos muestran como la caulerpal más extendida, *Caulerpa racemosa* var. *cylindracea* es la que presenta menor concentración de caulerpenina. La macroalga establecida en el Mediterráneo,

C. prolifera, es la que presenta una mayor concentración de caulerpenina además del mayor número de herbívoros especializados, por lo tanto la presencia de caulerpenina no es el principal responsable del éxito de las caulerpales invasoras.

- Las medidas de la concentración de caulerpenina han demostrado su utilidad para completar la interpretación de los datos de estrés oxidativo. *Caulerpa* al sufrir la presión de un herbívoro o epífitos, aumenta su concentración para causar el mayor daño.
- La combinación de las técnicas de marcadores de estrés oxidativo y medidas de caulerpenina son complementarias. La herbivoría como el epifitismo provocan un incremento de la concentración de la caulerpenina en *Caulerpa taxifolia*, induciendo un incremento en las defensas de *Caulerpa*, ya sea por el daño celular asociado a ambos, como a la mayor presencia de caulerpenina en el alga. En el caso del organismo herbívoro, *Bittium reticulatum*, su ingesta de *Caulerpa* provoca un aumento de la caulerpenina en el alga que a su vez hace necesario el aumento de los enzimas antioxidante en el herbívoro. En el caso de la macroalga *Lophocladia lallemandii*, capaz de epifitar *Caulerpa taxifolia*, provoca que esta aumente su concentración de caulerpenina, pero sin afectar negativamente a *L. lallemandii*.

En el actual estado de invasión, las comunidades de invertebrados en fondos someros de sustratos blandos con presencia de *Posidonia oceanica*, no muestran una reducción ni en sus abundancias ni en su diversidad. Los escenarios estudiados en Baleares, no muestran la formación de praderas monoespecíficas de caulerpales como se ha dado en otros puntos del litoral Mediterráneo (ej Cap Martin, Francia). La expansión y desarrollo de las invasoras es un problema dinámico, pudiéndose dar tanto su desaparición como total colonización del sustrato. La variabilidad estacional observada en Baleares es también muy marcada, por lo que tampoco se observan patrones de sucesión faunística propios de la expansión de las especies invasoras. Los datos apuntan a que el hábitat generado por las *Caulerpa* spp. permiten la coexistencia de las taxocenosis de praderas de *Posidonia oceanica* con la excepción de algunas especies.

Por todo ello, la expansión y evolución de las especies invasoras ha de ser monitorizada, pues los datos recogidos a lo largo de los cuatro años de tesis pueden

variar si el patrón de invasión cambia. En el caso de un aumento en la expansión de las caulerpales con formación de praderas monoespecíficas se daría una reducción o desplazamiento de las especies más especializadas y una proliferación de las especies más generalistas como los trabajos taxonómicos muestran.

Referencias bibliográficas

Referencias bibliogràficas

Bibliografía

- Aebi HE (1984) Catalase. In *Methods in Enzymatic Analysis*, ed. HU Bergmeyer, pp 273-286. Basel: Verlag Chemie.: 273-286.
- Ahmad I, Pacheco M, Santos MA (2006) *Anguilla anguilla* L. oxidative stress biomarkers: An in situ study of freshwater wetland ecosystem (Pateira de Fermentelos, Portugal). *Chemosphere* 65: 952-962.
- Almeida JA, Diniz YS, Marques SF, Faine LA, Ribas BO, Burneiko RC, Novelli EL (2002) The use of the oxidative stress responses as biomarkers in Nile tilapia (*Oreochromis niloticus*) exposed to in vivo cadmium contamination. *Environmental International* 27: 673-679.
- Alvarez S, Boveris A (1993) Induction of antioxidant enzymes and DT-diaphorase in human blood mononuclear cells by light stress. *Archives of Biochemistry Biophysiology* 305: 247-251.
- Amade P, Joncheray L, Brocque S, Pesando D (1998) Devenir de la caulerpenyne dans le milieu marin: etudes preliminaires experimentales et *in situ*. In: Boudouresque CF, Gravez V, Meinesz A, Palluy F (eds) *Third International Workshop on Caulerpa taxifolia*. GIS Posidonie publication., pp 133-142.
- Amade P, Lemee R (1998) Chemical defence of the Mediterranean alga *Caulerpa taxifolia*: variations in caulerpenyne production. *Aquatic Toxicology* 43: 287-300.
- Ames BN, Shigenaga MK, Hagen TM (1993) Oxidants, Antioxidants, and the Degenerative Diseases of Aging. *Proceedings of the National Academy of Sciences of the United States of America* 90: 7915-7922.
- Amico V, Oriente G, Piattelli M, Tringali C, Fattorusso E, Magno S, Mayol L (1978) Caulerpenyne, an Unusual Sesquiterpenoid from Green-Alga *Caulerpa prolifera*. *Tetrahedron Letters*: 3593-3596.
- Antoniadou C, Chintiroglou C (2006) Trophic relationships of polychaetes associated with different algal growth forms. *Helgoland Marine Research* 60: 39-49.
- Antoniadou C, Chintiroglou C (2007) Zoobenthos associated with the invasive red alga *Womersleyella setacea* (Rhodomelaceae) in the northern Aegean Sea. *Journal of the Marine Biological Association of the United Kingdom* 87: 629-641.

Referencias bibliográficas

- Argyrou M, Demetropoulos A, Hadjichristophorou M (1999) Expansion of the macroalga *Caulerpa racemosa* and changes in softbottom macrofaunal assemblages in Moni Bay, Cyprus. *Oceanologica Acta* 22: 517-528.
- Arigoni S, Francour P, Harmelin-Vivien M, Zaninetti L (2002) Adaptive colouration of Mediterranean labrid fishes to the new habitat provided by the introduced tropical alga *Caulerpa taxifolia*. *Journal of Fish Biology* 60: 1486-1497.
- Arrivillaga A, Baltz DM (1999) Comparison of fishes and macroinvertebrates on seagrass and bare-sand sites on Guatemala's Atlantic coast. *Bulletin of Marine Science* 65: 301-319.
- Asada K (1999) The water-water cycle in chloroplasts: Scavenging of active oxygens and dissipation of excess photons. *Annual Review of Plant Physiology and Plant Molecular Biology* 50: 601-639.
- Asada S, Fukuda K, Oh M, Hamanishi C, Tanaka S (1999) Effect of hydrogen peroxide on the metabolism of articular chondrocytes. *Inflammation Research* 48: 399-403.
- Balata D, Piazzini L, Cinelli F (2004) A comparison among assemblages in areas invaded by *Caulerpa taxifolia* and *C. racemosa* on a subtidal Mediterranean rocky bottom. *Marine Ecology-Pubblicazioni Della Stazione Zoologica Di Napoli I* 25: 1-13.
- Ballesteros E (2006) Mediterranean coralligenous assemblages: a synthesis of present knowledge. *Oceanography and Marine Biological. An Annual Review* 44: 123-195.
- Ballesteros E, Grau AM, Riera F (1999) *Caulerpa racemosa* (Forsskal) J. Agardh (Caulerpales, Chlorophyta) in Mallorca (Western Mediterranean). *Bolletí Societat d'Història Natural de les Illes Balears* 42: 63-69.
- Ballesteros E, Pinedo S (2004) Los bosques de algas pardas y rojas. In: Consejería de Medio Ambiente JdA (ed) *Praderas y Bosques Marinos de Andalucía*, Sevilla.
- Ballesteros M, Castelló J, Gallés M, Sarda R (1987) Invertebrados alguícolas marinos de las islas pitiusas.
- Barbera-Cebrian C, Sanchez-Jerez P, Ramos-Espla AA (2002) Fragmented seagrass habitats on the Mediterranean coast, and distribution and abundance of mysid assemblages. *Marine Biology* 141: 405-413.
- Barbier P, Guise S, Huitorel P, Amade P, Pesando D, Briand C, Peyrot V (2001) Caulerpenyne from *Caulerpa taxifolia* has an antiproliferative activity on tumor

Referencias bibliográficas

- cell line SK-N-SH and modifies the microtubule network. *Life Sciences* 70: 415-429.
- Bard SM (2000) Multixenobiotic resistance as a cellular defense mechanism in aquatic organisms. *Aquatic Toxicology* 48: 357-389.
- Barnich R, Fiege D (2003) The Aphroditoidea (Annelida: Polychaeta) of the Mediterranean Sea. *Abhandlungen* 559: 170 pp.
- Barrajon A, Ballesteros E, Corzo J, Corzo M, Cuesta S, Duarte CM, Flores A, Garcia JC, Garcia I, Garcia JE, Garcia-Raso JE, Gofas S, Gonzalez MI, Guerra JM, Hergueta E, Larrad A, Lopez CM, M. LFC, Lopez E, Luque A, Marba M, Moreno D, Ortiz M, Perez JL, Pinedo S, Ramos AA, Remon JM, Salgado JR, Romero J, Rueda JL, Salas C, Sanchez JL, Sanchez-Moyano JE, San Martin GA, Templado J, Terrados J (2004) *Praderas y Bosques marinos de Andalucía*. Junta de Andalucía, Sevilla.
- Bax N, Williamson A, Aguero M, Gonzalez E, Geeves W (2003) Marine invasive alien species: a threat to global biodiversity. *Marine Policy* 27: 313-323.
- BellanSantini D, Arnaud PM, Bellan G, Verlaque M (1996) The influence of the introduced tropical alga *Caulerpa taxifolia*, on the biodiversity of the Mediterranean marine biota. *Journal of the Marine Biological Association of the United Kingdom* 76: 235-237.
- Bianchi CN (1981) *Policheti Serpuloidei*, Genova.
- Bianchi TS, Argyrou M, Chippett HF (1999) Contribution of vascular-plant carbon to surface sediments across the coastal margin of Cyprus (eastern Mediterranean). *Organic Geochemistry* 30: 287-297.
- Bologna PAX, Heck KL (2000) Impacts of seagrass habitat architecture on bivalve settlement. *Estuaries* 23: 449-457.
- Borg JA, Attrill MJ, Rowden AA, Schembri PJ, Jones MB (2005) Architectural characteristics of two bed types of the seagrass *Posidonia oceanica* over different spatial scales. *Estuarine Coastal and Shelf Science* 62: 667-678.
- Borg JA, Rowden AA, Attrill MJ, Schembri PJ, Jones MB (2006) Wanted dead or alive: high diversity of macroinvertebrates associated with living and 'dead' *Posidonia oceanica* matte. *Marine Biology* 149: 667-677.
- Boström C, Bonsdorff E (1997) Community structure and spatial variation of benthic invertebrates associated with *Zostera marina* (L.) beds in the northern Baltic Sea. *Journal of Sea Research* 37: 153-166.

Referencias bibliográficas

- Boudouresque CF (1998) Follow up of biological introduction in the sea. *Biofutur*: 76-78.
- Boudouresque CF (2004) Marine biodiversity in the Mediterranean: status of species, populations, and communities., Port-Cros nat. Park, France.
- Boudouresque CF, Lemee R, Mari X, Meinesz A (1996) The invasive alga *Caulerpa taxifolia* is not a suitable diet for the sea urchin *Paracentrotus lividus*. *Aquatic Botany* 53: 245-250.
- Boudouresque CF, Meinesz A, Ribera MA, Ballesteros E (1995) Spread of the green alga *Caulerpa taxifolia* (Caulerpales, Chlorophyta) in the Mediterranean: Possible consequences of a major ecological event. *Scientia Marina* 59: 21-29.
- Boudouresque CF, Verlaque M (2002) Biological pollution in the Mediterranean Sea: invasive versus introduced macrophytes. *Marine Pollution Bulletin* 44: 32-38.
- Brito MC, Martin D, Nunez J (2005) Polychaetes associated to a *Cymodocea nodosa* meadow in the Canary Islands: assemblage structure, temporal variability and vertical distribution compared to other Mediterranean seagrass meadows. *Marine Biology* 146: 467-481.
- Brunelli M, Garcia-Gil M, Mozzachiodi R, Roberto M, Scuri R, Traina G, Zaccardi ML (2000) Neurotoxic effects of caulerpenyne. *Progress in Neuro-Psychopharmacology & Biological Psychiatry* 24: 939-954.
- Buia MC, Gambi MC, Terlizzi A, Mazzella L (2001) Colonization of *Caulerpa racemosa* along the southern Italian coast: I. Distribution, phenological variability and ecological role. In: Gravez V, Ruitton S, Boudouresque CF, Le Direac'h L, Meinesz A, G. S (eds) Fourth International Workshop on *Caulerpa taxifolia*. GIS Posidonie, France, pp 352-360.
- Buia MC, Gambi MC, Zupo V (2000) Structure and functioning of Mediterranean seagrass ecosystems: an overview. *Biologia Marina Mediterranea* 7: 167-190.
- Buschmann, A.H., 1990. Intertidal Macroalgae as Refuge and Food for Amphipoda in Central Chile. *Aquatic Botany* 36 (3), 237-245.
- Campoy A (1982) Fauna de Anelidos Poliquetos de la Península Ibérica. Universidad de Navarra, Navarra.
- Camus L, Pampanin DM, Volpato E, Delaney E, Sanni S, Nasci C (2004) Total oxyradical scavenging capacity responses in *Mytilus galloprovincialis* transplanted into the Venice lagoon (Italy) to measure the biological impact of anthropogenic activities. *Mar. Pollut. Bull.* 49: 801-808.

Referencias bibliográficas

- Cardoso PG, Pardal MA, Raffaelli D, Baeta A, Marques JC (2004) Macroinvertebrate response to different species of macroalgal mats and the role of disturbance history. *Journal of Experimental Marine Biology and Ecology* 308: 207-220.
- Carlton JT, Geller JB (1993) Ecological Roulette - the Global Transport of Nonindigenous Marine Organisms. *Science* 261: 78-82.
- Cavas L, Yurdakoc K (2005a) A comparative study: Assessment of the antioxidant system in the invasive green alga *Caulerpa racemosa* and some macrophytes from the Mediterranean. *Journal of Experimental Marine Biology and Ecology* 321: 35-41.
- Cavas L, Yurdakoc K (2005b) An investigation on the antioxidant status of the invasive alga *Caulerpa racemosa* var. *cylindracea* (Sonder) Verlaque, Huisman, et Boudouresque (Caulerpales, Chlorophyta). *Journal of Experimental Marine Biology and Ecology* 325: 189-200.
- Cavas L, Yurdakoc K, Yokes B (2005b) Antioxidant status of *Lobiger serradifalci* and *Oxynoe olivacea* (Opisthobranchia, Mollusca). *Journal of Experimental Marine Biology and Ecology* 314: 227-235.
- Ceccherelli G, Campo D (2002) Different effects of *Caulerpa racemosa* on two co-occurring seagrasses in the Mediterranean. *Botanica Marina* 45: 71-76.
- Ceccherelli G, Cinelli F (1999a) Effects of *Posidonia oceanica* canopy on *Caulerpa taxifolia* size in a north-western Mediterranean bay. *Journal of Experimental Marine Biology and Ecology* 240: 19-36.
- Ceccherelli G, Cinelli F (1999b) A pilot study of nutrient enriched sediments in a *Cymodocea nodosa* bed invaded by the introduced alga *Caulerpa taxifolia*. *Botanica Marina* 42: 409-417.
- Ceccherelli G, Piazzini L, Balata D (2002) Spread of introduced *Caulerpa* species in macroalgal habitats. *Journal of Experimental Marine Biology and Ecology* 280: 1-11.
- Clarkson PM, Thompson HS (2000) Antioxidants: what role do they play in physical activity and health? *American Journal of Clinical Nutrition* 72: 637S-646S.
- Collen J, Ekdahl A, Abrahamsson K, Pedersen M (1994) The Involvement of Hydrogen-Peroxide in the Production of Volatile Halogenated Compounds by *Meristiella-Gelidium*. *Phytochemistry* 36: 1197-1202.
- Collen J, Pedersen M (1996) Production, scavenging and toxicity of hydrogen peroxide in the green seaweed *Ulva rigida*. *European Journal of Phycology* 31: 265-271.

Referencias bibliográficas

- Collen J, Pinto E, Pedersen M, Colepicolo P (2003) Induction of oxidative stress in the red macroalga *Gracilaria tenuistipitata* by pollutant metals. *Archives of Environmental Contamination and Toxicology* 45: 337-342.
- Connolly RM (1997) Differences in composition of small, motile invertebrate assemblages from seagrass and unvegetated habitats in a southern Australian estuary. *Hydrobiologia* 346: 137-148.
- Cutignano A, Notti V, d'Ippolito G, Coll AD, Cimino G, Fontana A (2004) Lipase-mediated production of defensive toxins in the marine mollusc *Oxynoe olivacea*. *Organic & Biomolecular Chemistry* 2: 3167-3171.
- Chessa LA, Bionda G, Buia MC, Gambi C, Lorenti M, Maj R, Manconi R, Martinelli M, Pintus MG, Russo GF, Scipione MB, Taramelli E (1989) Indagini su *Posidonia oceanica* nella rada di Porto Conte (Sadezna Nord-Occidentale): Caratteristiche della prateria e fauna vagile. *Oebalia* XV: 99-107.
- Chimenz C, Taramelli E, Cironi R, Contessini A, Gravina F, Maggiore F, Maj R, Motta M, Somaschini A (1989) Studies on animal populations of leaves and rhizomes of *Posidonia oceanica* (L.) Delile on the rocky bottom of Torvaldaliga. In: Boudouresque CF, Meinesz A, Fresi E, Gravez V (eds) *International Workshop on Posidonia Beds. G.I.S Posidonie, Ischia (Italy)*, pp 145-155.
- Choo KS, Snoeijjs P, Pedersen M (2004) Oxidative stress tolerance in the filamentous green algae *Cladophora glomerata* and *Enteromorpha ahlnneriana*. *Journal of Experimental Marine Biology and Ecology* 298: 111-123.
- Chovanec A, Hofer R, Schiemer F (2003) Fish as bioindicators. In: Markert, B. A., Breure, A. M., Zechmeister, H. G. (Eds.). *Bioindicators and Biomonitoring*. Elsevier Science .
- Dantart M, Frechilla M, Ballesteros M (1990) Fauna malacologica del Estany des Peix (Formentera). *Iberus* 9: 111-125.
- Davies KJA (1995) Oxidative stress, the paradox of aerobic life. In: Rice-Evans C, Halliwell B, Land GG (eds) *Free Radical and Oxidative Stress: Environment, Drugs and Food Additives*. Portland Press, London, pp 1-31.
- de la Rosa IL, Garcia-Raso JEG, Rodriguez A (2002) Evolution of a decapod community (Crustacea) of shallow soft bottoms with seaweeds from southern Europe. *Journal of the Marine Biological Association of the United Kingdom* 82: 85-95.

Referencias bibliográficas

- de la Rosa IL, Rodriguez A, Garcia-Raso JEG (2006) Seasonal variation and structure of a decapod (Crustacea) assemblage living in a *Caulerpa prolifera* meadow in Cadiz Bay (SW Spain). *Estuarine Coastal and Shelf Science* 66: 624-633.
- Dean RL, Connell JH (1987) Marine-Invertebrates in an Algal Succession .3. Mechanisms Linking Habitat Complexity with Diversity. *Journal of Experimental Marine Biology and Ecology* 109: 249-273.
- DeLeve LD, Kaplowitz N (1991) Glutathione metabolism and its role in hepatotoxicity. *Pharmacology* 52: 287-305.
- Devillele X, Verlaque M (1995) Changes and Degradation in a *Posidonia oceanica* Bed Invaded by the Introduced Tropical Alga *Caulerpa taxifolia* in the North-Western Mediterranean. *Botanica Marina* 38: 79-87.
- Di Giulio RT, Habig C, Gallagher EP (1993) Effects of black rock harbour sediments on indices of biotransformation, oxidative stress and DNA integrity in channel catfish. *Aquatic Toxicology*. 26: 1-22.
- Diaz-Almela E, Arnaud-Haond S, Vliet MS, Alvarez E, Marba N, Duarte CM, Serrao EA (2007) Feed-backs between genetic structure and perturbation-driven decline in seagrass (*Posidonia oceanica*) meadows. *Conservation Genetics* 8: 1377-1391.
- Dimech M, Borg JA, Schembri PJ (2002) Changes in the structure of a *Posidonia oceanica* meadow and in the diversity of associated decapod, mollusc and echinoderm assemblages, resulting from inputs of waste from a marine fish farm (Malta, Central Mediterranean). *Bulletin of Marine Science* 71: 1309-1321.
- Doty MS (1966) Caulerpicin a Toxic Constituent of *Caulerpa*. *Nature* 211: 990-&.
- d'Udekem d'Acoz C (1999) Inventaire et distribution des crustacés décapodes de l'Atlantique nord-oriental, de la Méditerranée et des eaux continentales adjacentes au nord de 25°N. *Servei du Patrimoine Naturell, Institut d'Écologie et des Gestion de la Biodiversité, Paris*.
- Dumay O, Pergent G, Pergent-Martini C, Amade P (2002) Variations in caulerpenyne contents in *Caulerpa taxifolia* and *Caulerpa racemosa*. *Journal of Chemical Ecology* 28: 343-352.
- Edgar GJ, Shaw C, Watson GF, Hammond LS (1994) Comparisons of Species Richness, Size-Structure and Production of Benthos in Vegetated and Unvegetated Habitats in Western-Port, Victoria. *Journal of Experimental Marine Biology and Ecology* 176: 201-226.

Referencias bibliográficas

- Elias SJ, Arner ES, Zhong L, Holmgren A (1999) In: Packer L (ed) Methods in Enzymatic Analysis. Oxidants and Antioxidants. Academic Press, California vol. 300: pp 226-239.
- Ergen Z, Kocatas A, Katagan T, Onem M (1988) The distribution of Polychaeta and Crustacea found in *Posidonia oceanica* meadows of Izmir Bay (Turkey). Rapp. Comm. int. Mer Médit 31: 25.
- Erickson AA, Paul VJ, Van Alstyne KL, Kwiatkowski LM (2006) Palatability of macroalgae that use different types of chemical defenses. Journal of Chemical Ecology 32: 1883-1895.
- Fauchald K, Jumars P (1979) The diet of worms: a study of Polychaeta feeding guilds. Oceanography and Marine Biological. An Annual Review 17: 193-284.
- Fauvel P (1923) Faune de France, Polychètes Errantes, Paris.
- Fauvel P (1927) Faune de France, Polychètes Sédentaires, Paris.
- Ferrer E, Garreta AG, Ribera MA (1997) Effect of *Caulerpa taxifolia* on the productivity of two Mediterranean macrophytes. Marine Ecology-Progress Series 149: 279-287.
- Fitzhugh K (1989) A Systematic Revision of the Sabellidae-Caobangiidae-Sabellongidae Complex (Annelida: Polychaeta). Bulletin of the American Museum of Natural History 192: 104 pp.
- Flohe L, Gunzler WA (1984) Assays for glutathione peroxidase. Methods in Enzymology 105: 114-121.
- Forest J (1965) Campagnes du "Professeur Lacaze-Duthiers" aux Baléares: Juin 1953 et Aout 1954 Crustacés Décapodes. Vie et Milieu 16: 325-413.
- Francour P (1997) Fish assemblages of *Posidonia oceanica* beds at Port Cros (France, NW Mediterranean): Assessment of composition and long- term fluctuations by visual census 18: 157-173.
- Francour P, Harmelinvivié M, Harmelin JG, Duclerc J (1995) Impact of *Caulerpa taxifolia* Colonization on the Littoral Ichthyofauna of North-Western Mediterranean-Sea - Preliminary-Results. Hydrobiologia 301: 345-353.
- Frenzilli G, Bocchetti R, Pagliarecci M, Nigro M, Annarumma F, Scarcelli V, Fattorini D, Regoli F (2004) Time-course evaluation of ROS- mediated toxicity in mussels, *Mytilus Galloprovincialis*, during a field translocation experiment. Marine Environmental Research 58: 609-613.

Referencias bibliográficas

- Galil BS (2007) Loss or gain? Invasive aliens and biodiversity in the Mediterranean Sea. *Marine Pollution Bulletin* 55: 314-322.
- Gallmetzer I, Pflugfelder B, Zekely J, Ott JA (2005) Macrofauna diversity in *Posidonia oceanica* detritus: distribution and diversity of mobile macrofauna in shallow sublittoral accumulations of *Posidonia oceanica* detritus. *Marine Biology* 147: 517-523.
- Gambi MC, Conti G, Bremec CS (1998) Polychaete distribution, diversity and seasonality related to seagrass cover in shallow soft bottoms of the Tyrrhenian Sea (Italy) 62: 1-17.
- Gambi MC, Giangrande A, Martinelli M, Chessa LA (1995) Polychaetes of a *Posidonia oceanica* Bed Off Sardinia (Italy) - Spatiotemporal Distribution and Feeding Guild Analysis. *Scientia Marina* 59: 129-141.
- Gambi MC, Lorenti M, Russo GF, Scipione MB, Zupo V (1992) Depth and Seasonal Distribution of Some Groups of the Vagile Fauna of the *Posidonia oceanica* Leaf Stratum - Structural and Trophic Analyses 13: 17-39.
- Ganteaume A, Gobert J, Malestroit P, Menager V, Francour P, Boudouresque CF (1998) In vitro consumption of *Caulerpa taxifolia* (Chlorophyta) by accustomed and non-accustomed *Paracentrotus lividus* (Echinoid): Seasonal variations. *Journal of the Marine Biological Association of the United Kingdom* 78: 239-248.
- Gardner PR, Fridovich I (1991) Superoxide Sensitivity of the Escherichia-Coli 6-Phosphogluconate Dehydratase. *Journal of Biological Chemistry* 266: 1478-1483.
- Gavagnin M, Marin A, Castelluccio F, Villani G, Cimino G (1994) Defensive Relationships between *Caulerpa prolifera* and Its Shelled Sacoglossan Predators. *Journal of Experimental Marine Biology and Ecology* 175: 197-210.
- Gavagnin M, Mollo E, Montanaro D, Ortea J, Cimino G (2000) Chemical studies of Caribbean sacoglossans: Dietary relationships with green algae and ecological implications. *Journal of Chemical Ecology* 26: 1563-1578.
- Gianguzza P, Airoidi L, Chemello R, Todd CD, Riggio S (2002) Feeding preferences of *Oxynoe olivacea* (Opisthobranchia : Sacoglossa) among three *Caulerpa* species. *Journal of Molluscan Studies* 68: 289-290.
- Giannuzi-Savelli R, Pusateri F, Palmeri A, Ebreo C (1994) Atlante delle conchiglie marine del Mediterraneo. Vol I (Archaeogastropoda), Roma.

Referencias bibliográficas

- Giannuzi-Savelli R, Pusateri F, Palmeri A, Ebreo C (1996) Atlante delle conchiglie marine del Mediterraneo. Vol 2 (Caenogastropoda parte 1: Discopoda-Heteropoda), Roma.
- Giannuzi-Savelli R, Pusateri F, Palmeri A, Ebreo C (1999) Atlante delle conchiglie marine del Mediterraneo. Vol 3 (Caenogastropoda, parte 2: Ptenoglossa), Roma.
- Girard JP, Szpunar J, Pedrotti ML, Pesando D (2000) Toxicity of tri-n-butyltin to sea urchin eggs and larvae: Relation to bioaccumulation at the nanomolar level. *Environmental Toxicology and Chemistry* 19: 1272-1277.
- Goldberg DM, Spooner RJ (1984) Glutathione reductase. *Methods in Enzymatic Analysis*: 00 258-265.
- Gollasch S (2006) Overview on introduced aquatic species in European navigational and adjacent waters. *Helgoland Marine Research* 60: 84-89.
- Gravato C, Oliveire M, Santos MA (2005) Oxidative stress and genotoxic responses to resin acids in Mediterranean mussels. *Ecotoxicology and Environmental Safety* 61: 221-229.
- Gribben PE, Wright JT (2006) Invasive seaweed enhances recruitment of a native bivalve: roles of refuge from predation and the habitat choice of recruits. *Marine Ecology-Progress Series* 318: 177-185.
- Gross H, Goeger DE, Hills P, Mooberry SL, Ballantine DL, Murray TF, Valeriote FA, Gerwick WH (2006) Lophocladines, bioactive alkaloids from the red alga *Lophocladia* sp. *Journal of Natural Products* 69: 640-644.
- Guerra-Garcia JM, Sanchez-Moyano JE, Garcia-Gomez JC (2002) *Caprella caulerpensis* (Crustacea : Amphipoda), a new species associated with *Caulerpa prolifera* from the Strait of Gibraltar. *Journal of the Marine Biological Association of the United Kingdom* 82: 843-846.
- Guerriero A, Depentori D, Dambrosio M, Pietra F (1995) Caulerpenyne-Amine Reacting System As a Model For in-Vivo Interactions of Ecotoxicologically Relevant Sesquiterpenoids of the Mediterranean-Adapted Tropical Green Seaweed *Caulerpa taxifolia*. *Helvetica Chimica Acta* 78: 1755-1762.
- Habig WH, Pabst MJ, Jakoby WB (1974) Glutathione S-transferases. The first enzymatic step in mercapturic acid formation. *Journal of Biological Chemistry* 249: 7130-7139.
- Halliwell B (1994) Free radicals, antioxidants, and human disease: curiosity, cause, or consequence? *Lancet* 344: 721-724.

Referencias bibliográficas

- Harmelin-Vivien M (1982) Ichtyofaune des herbiers à *Posidonia oceanica* du parc national de Port-Cros. I. Composition et variations spatio-temporelles. Trav Sci Parc Nation Port-Cros 8: 69-72.
- Harmelin-Vivien M (1984) Ichtyofaune des herbiers de Posidonies du parc natural regional de Corse. In: Boudouresque CF, A. dG, Olivier J (eds) International workshop on *Posidonia oceanica* beds. GIS Posidonie Publications, France, pp 291-301.
- Hay ME, Fenical W (1988) Marine Plant-Herbivore Interactions - the Ecology of Chemical Defense. Annual Review of Ecology and Systematics 19: 111-145.
- Hillman K, McComb AJ, Walker DI (1995) The Distribution, Biomass and Primary Production of the Seagrass *Halophila ovalis* in the Swan-Canning Estuary, Western-Australia. Aquatic Botany 51: 1-54.
- Hippeli S, Heiser I, Elstner EF (1999) Activated oxygen and free oxygen radicals in pathology: New insights and analogies between animals and plants. Plant Physiology and Biochemistry 37: 167-178.
- Imajima M (1982) Maldanidae (Annelida: Polychaete) from Japan (Part 1). Bulletin of the National Science Museum 8: 88 pp.
- Imlay JA, Linn S (1988) DNA Damage and Oxygen Radical Toxicity. Science 240: 1302-1309.
- Ingle R (1993) Hermit Crabs of The Northeastern Atlantic and Mediterranean Sea, an Illustrated Key. Chapman & Hall, London.
- Jaubert JM, Chisholm JRM, Minghelli-Roman A, Marchioretta M, Morrow JH, Ripley HT (2003) Re-evaluation of the extent of *Caulerpa taxifolia* development in the northern Mediterranean using airborne spectrographic sensing. Marine Ecology-Progress Series 263: 75-82.
- Jos A, Pichardo S, Prieto AI, Repetto G, Vazquez CM, Moreno I, Camean AM (2005) Toxic cyanobacterial cells containing microcystins induce oxidative stress in exposed tilapia fish (*Oreochromis* sp.) under laboratory conditions. Aquatic Toxicology 72: 261-271.
- Jousson O, Pawlowski J, Zaninetti L, Meinesz A, Boudouresque CF (1998) Molecular evidence for the aquarium origin of the green alga *Caulerpa taxifolia* introduced to the Mediterranean Sea. Marine Ecology-Progress Series 172: 275-280.
- Jung V, Pohnert G (2001) Rapid wound-activated transformation of the green algal defensive metabolite caulerpenyne. Tetrahedron 57: 7169-7172.

Referencias bibliográficas

- Jung V, Thibaut T, Meinesz A, Pohnert G (2002) Comparison of the wound-activated transformation of caulerpenyne by invasive and noninvasive *Caulerpa* species of the Mediterranean. *Journal of Chemical Ecology* 28: 2091-2105.
- Katagan T, Kocatas A (2001) New localities for *Automate branchialis* Holthuis & Gottlieb, 1958 (Decapoda, Alpheidae) in the Mediterranean Sea. *Crustaceana* 74: 1387-1391.
- Kondo F, Matsumoto H, Yamada S, Ishikawa N, Ito E, Nagata S, Ueno Y, Suzuki M, Harada K (1996) Detection and identification of metabolites of microcystins formed in vivo in mouse and rat livers. *Chemical Research in Toxicology* 9: 1355-1359.
- Koulouri P, Dounas C, Arvanitidis C, Koutsoubas D, Eleftheriou A (2006) Molluscan diversity along a Mediterranean soft bottom sublittoral ecotone. *Scientia Marina* 70: 573-583.
- Lemee R, Boudouresque CF, Gobert J, Malestroit P, Mari X, Meinesz A, Menager V, Ruitton S (1996) Feeding behaviour of *Paracentrotus lividus* in the presence of *Caulerpa taxifolia* introduced in the Mediterranean Sea. *Oceanologica Acta* 19: 245-253.
- Lepoint G, Havelange S, Gobert S, Bouquegneau JM (1999) Fauna vs flora contribution to the leaf epiphytes biomass in a *Posidonia oceanica* seagrass bed (Revellata Bay, Corsica) 394: 63-67.
- Levi F, Boutoute M, Mayzaud P (2005) Lipid composition of *Symphodus ocellatus* (Perciforme : Labridae) in the north-western Mediterranean: influence of two different biotopes. *Marine Biology* 146: 805-814.
- Levi F, Francour P (2004) Behavioural response of *Mullus surmuletus* to habitat modification by the invasive macroalga *Caulerpa taxifolia*. *Journal of Fish Biology* 64: 55-64.
- Li M, Hu C, Zhu Q, Chen L, Kong Z, Liu Z (2006) Copper and zinc induction of lipid peroxidation and effects on antioxidant enzyme activities in the microalga *Pavlova viridis* (Prymnesiophyceae). *Chemosphere* 62: 565-572.
- Livingstone DR (1991) Towards a Specific Index of Impact by Organic Pollution for Marine-Invertebrates. *Comparative Biochemistry and Physiology C-Pharmacology Toxicology & Endocrinology* 100: 151-155.
- Livingstone DR (2001) Contaminant-stimulated reactive oxygen species production and oxidative damage in aquatic organisms. *Marine Pollution Bulletin* 42: 656-666.

Referencias bibliográficas

- Livingstone DR, Lemaire P, Matthews A, Peters LD, Porte C, Fitzpatrick PJ, Forlin L, Nasci C, Fossato V, Wootton N, Goldfarb P (1995) Assessment of the Impact of Organic Pollutants on Goby (*Zosterisessor ophiocephalus*) and Mussel (*Mytilus galloprovincialis*) from the Venice Lagoon, Italy - Biochemical-Studies. *Marine Environmental Research* 39: 235-240.
- Livingstone DR, Lips F, Martinez PG, Pipe RK (1992) Antioxidant Enzymes in the Digestive Gland of the Common Mussel *Mytilus edulis*. *Marine Biology* 112: 265-276.
- Livingstone DR (2001) Contaminant-stimulated reactive oxygen species production and oxidative damage in aquatic organisms. *Marine Pollution Bulletin* 42: 656-666.
- Longepierre S, Robert A, Levi F, Francour P (2005) How an invasive alga species (*Caulerpa taxifolia*) induces changes in foraging strategies of the benthivorous fish *Mullus surmuletus* in coastal Mediterranean ecosystems. *Biodiversity and Conservation* 14: 365-376.
- MacDougall AS, Turkington R (2005) Are invasive species the drivers or passengers of change in degraded ecosystems? *Ecology* 86: 42-55.
- Mack RN, Simberloff D, Lonsdale WM, Evans H, Clout M, Bazzaz FA (2000) Biotic invasions: Causes, epidemiology, global consequences, and control. *Ecological Applications* 10: 689-710.
- Mahendran M, Somasundaram S, Thomson RH (1979) Revised Structure for Caulerpicin from *Caulerpa racemosa*. *Phytochemistry* 18: 1885-1886.
- Maiti BC, Thomson RH, Mahendran M (1978) Structure of Caulerpin, a Pigment from *Caulerpa* Algae. *Journal of Chemical Research-S*: 126-127
- Marin A, Ros J (2004) Chemical defenses in Sacoglossan Opisthobranchs: Taxonomic trends and evolutive implications. *Scientia Marina* 68: 227-241.
- Martin D, Pinedo S, Sarda R (2000) Distribution patterns and trophic structure of soft-bottom polychaeta assemblages in north-western Mediterranean shallow-water bay. *Ophelia* 53: 1-17.
- Martinez-Alvarez RM, Morales AE, Sanz A (2005) Antioxidant defenses in fish: Biotic and abiotic factors. *Reviews in Fish Biology and Fisheries* 15: 75-88.
- Mazzella L, Buia MC, Gambi C, Lorenti L, Russo GF, Scipione MB, Zupo V (1986) Plant-animal trophic relationships in the *Posidonia oceanica* ecosystem of the Mediterranean Sea: A Review. In: John DM, Hawkins SJ, Price JH (eds) *Plant*

Referencias bibliográficas

- animal interactions in the Marine Benthos. Systematics Association Special Volume, Oxford, pp 165-187.
- Meinesz A (1979) Contribution to the Study of *Caulerpa prolifera* (Forsskal) Lamouroux (Chlorophyceae, Caulerpales) .1. Morphogenesis and Growth at a Station Off the French Continental Coast of the Mediterranean Sea. *Botanica Marina* 22: 27-39.
- Meinesz A (1997) The alga *taxifolia*'s implacable advance. *Recherche*: 46-48.
- Meinesz A (2004) *Caulerpa taxifolia* continues its invasion. *Biofutur* 244: 41-46.
- Meinesz A, Belsher T, Thibaut T, Antolic B, Mustapha KB, Boudouresque CF, Chiaverini D, Cinelli F, Cottalorda JM, Djellouli AS, El Abed A, Orestano C, Grau AM, Ivesa L, Vaugelas I, Zavodnik N, Zuljevic A (2001) The introduced green alga *Caulerpa taxifolia* continues to spread in Mediterranean. *Biological Invasions* 3: 201-210.
- Meinesz A, Devaugelas J, Hesse B, Mari X (1993) Spread of the Introduced Tropical Green-Alga *Caulerpa taxifolia* in Northern Mediterranean Waters. *Journal of Applied Phycology* 5: 141-147.
- Meinesz A, Hesse B (1991) Introduction of the Tropical Alga *Caulerpa taxifolia* and Its Invasion of the Northwestern Mediterranean. *Oceanologica Acta* 14: 415-426.
- Meyer KD, Paul VJ (1992) Intraplant Variation in Secondary Metabolite Concentration in 3 Species of *Caulerpa* (Chlorophyta, Caulerpales) and Its Effects on Herbivorous Fishes. *Marine Ecology-Progress Series* 82: 249-257.
- Mienis HK (1999) *Strombus persicus* on the fishmarket of Yafo, Israel. *De Kreukel* 35: 112.
- Minchin D, Rosenthal H (2002) Exotics for stoking and aquaculture, making correct decisions. In: Leppakoski E (ed) *Invasive aquatic species of Europe. Distribution, impacts and management*. Kluwer Academic Publishers, Dordrecht.
- Monteiro DA, de Almeida JA, Rantin FT, Kalinin AL (2006) Oxidative stress biomarkers in the freshwater characid fish, *Brycon cephalus*, exposed to organophosphorus insecticide Folisuper 600 (methyl parathion). *Comparative Biochemistry and Physiology part C Toxicology and Pharmacology* 143: 141-149.

Referencias bibliográficas

- Mozzachiodi R, Scuri R, Roberto M, Brunelli M (2001) Caulerpenyne, a toxin from the seaweed *Caulerpa taxifolia*, depresses after hyperpolarization in invertebrate neurons. *Neuroscience* 107: 519-526.
- Murillo GL, Talavera PA (1983) Aportación a la malacología de una laguna litoral: el mar menor (Murcia). *Iberus* 3: 15-28.
- Ngoc-ho N (2003) European and Mediterranean Thalassinidea (Crustacea, Decapoda). *Zoosystema* 25: 439-555.
- Nielsen PG, Carle JS, Christophersen C (1982) Final Structure of Caulerpicin, a Toxin Mixture from the Green-Alga *Caulerpa racemosa*. *Phytochemistry* 21: 1643-1645.
- Niwa Y, Ozaki T, Kanoh T, Akamatsu H, Kurisaka M (1996) Role of cytokines, tyrosine kinase and protein kinase C on production of superoxide and induction of scavenging enzymes in human leukocytes. *Clin.Immunol. Immunopathol.* 79: 303-313.
- Noel PY (1992) Cle préliminaire d'identification des crustacea decapoda de France et des principales autres espèces d'Europe. *Museum National d'Histoire Naturelle, Paris.*
- Nordsieck F (1969) *Die europäischen Meeresmuscheln (Bivalvia)*. Gustav Fischer Verlag, Stuttgart.
- Nordsieck F (1972) *Die europäischen Meeresschnecken (opisthobranchia mit Pyramidellidae; Rissoacea)*. Gustav Fischer Verlag, Stuttgart.
- Nordsieck F (1982) *Euroäischen Meeres-Gehäuseschnecken (Prosobranchia)*. Gustav Fischer Verlag, Stuttgart.
- Occhipinti-Ambrogi A, Savini D (2003) Biological invasions as a component of global change in stressed marine ecosystems. *Marine Pollution Bulletin* 46: 542-551.
- Ohsawa N, Tsujita M, Morikawa S, Itoh N (2001) Purification and characterization of a monohalomethane-producing enzyme S-adenosyl-L-methionine: Halide ion methyltransferase from a marine microalga, *Pavlova pinguis*. *Bioscience Biotechnology and Biochemistry* 65: 2397-2404.
- Olenin S, Leppakoski E (1999) Non-native animals in the Baltic Sea: alteration of benthic habitats in coastal inlets and lagoons. *Hydrobiologia* 393: 233-243.
- Packer L (1997) Oxidants, antioxidant nutrients and the athlete. *Journal of Sports Science* 15: 353-363.

Referencias bibliográficas

- Padilla DK, Williams SL (2004) Beyond ballast water: aquarium and ornamental trades as sources of invasive species in aquatic ecosystems. *Frontiers in Ecology and the Environment* 2: 131-138.
- Pampanin DM, Camus L, Gomiero A, Marangon I, Volpato E, Nasci C (2005) Susceptibility to oxidative stress of mussels (*Mytilus galloprovincialis*) in the Venice Lagoon (Italy). *Marine Pollution Bulletin* 50: 1548-1557.
- Pandolfo A, Chemello R (1995) Prime nota sulla malacofauna associata a *Caulerpa racemosa* nella Baia di Santa Panagia (Sicilia orientale). *Biologia Marina Mediterranea* 2: 649-651.
- ParentMassin D, Fournier V, Amade P, Lemee R, DurandClement M, Delescluse C, Pesando D (1996) Evaluation of the toxicological risk to humans of caulerpenyne using human hematopoietic progenitors, melanocytes, and keratinocytes in culture. *Journal of Toxicology and Environmental Health* 47: 47-59.
- Pastore A, Federici G, Bertini E, Piemonte F (2003) Analysis of glutathione: implication in redox and detoxification. *Clinical Chi Acta* 333: 19-39.
- Patzner R (1998) The invasion of *Lophocladia* (Rhodomelaceae, Lophotaliae) at the northern coast of Ibiza (Western Mediterranean Sea). *Bolletí Societat d'Història Natural de les Illes Balears* 41: 75-80.
- Paul VJ, Fenical W (1986) Chemical Defense in Tropical Green-Algae, Order Caulerpales. *Marine Ecology-Progress Series* 34: 157-169.
- Paul VJ, Hay ME (1986) Seaweed Susceptibility to Herbivory - Chemical and Morphological Correlates. *Marine Ecology-Progress Series* 33: 255-264.
- Paul VJ, Vanalstyne KL (1992) Activation of Chemical Defenses in the Tropical Green-Algae *Halimeda* Spp. *Journal of Experimental Marine Biology and Ecology* 160: 191-203.
- Pedrotti ML, Lemee R (1999) Effect of microalgae treated with natural toxins on the nutrition and development of filter-feeding sea-urchin larvae. *Marine Environmental Research* 48: 177-192.
- Pedrotti ML, Marchi B, Lemee R (1996) Effects of *Caulerpa taxifolia* secondary metabolites on the embryogenesis, larval development and metamorphosis of the sea urchin *Paracentrotus lividus*. *Oceanologica Acta* 19: 255-262.

Referencias bibliográficas

- Pesando D, Huitorel P, Dolcini V, Amade P, Girard JP (1998) Caulerpenyne interferes with microtubule-dependent events during the first mitotic cycle of sea urchin eggs. *European Journal of Cell Biology* 77: 19-26.
- Pesando D, Lemee R, Ferrua C, Amade P, Girard JP (1996) Effects of caulerpenyne, the major toxin from *Caulerpa taxifolia* on mechanisms related to sea urchin egg cleavage. *Aquatic Toxicology* 35: 139-155.
- Pffugmacher S, Wiegand C, Oberemm A, Beattie KA, Krause E, Codd GA, Steinberg C (1998) Identification of an enzymatically-formed glutathione conjugated of the cyanobacterial hepatotoxin microcystin-LR. The first step of detoxification. *Biochemistry Biophysics. Acta* 1425: 527-533.
- Phillips JA, Price IR (2002) How different is Mediterranean *Caulerpa taxifolia* (Caulerpales : Chlorophyta) to other populations of the species? *Marine Ecology-Progress Series* 238: 61-71.
- Piazzì L, Balata D (2008) The spread of *Caulerpa racemosa* var. *cylindracea* in the Mediterranean Sea: An exemple of how biological invasions can influence beta diversity. *Marine Environmental Research* 65: 50-61.
- Piazzì L, Balata D, Ceccherelli G, Cinelli F (2001a) Comparative study of the growth of the two co-occurring introduced green algae *Caulerpa taxifolia* and *Caulerpa racemosa* along the Tuscan coast (Italy, western Mediterranean). *Cryptogamie Algologie* 22: 459-466.
- Piazzì L, Balata D, Ceccherelli G, Cinelli F (2005) Interactive effect of sedimentation and *Caulerpa racemosa* var. *cylindracea* invasion on macroalgal assemblages in the Mediterranean Sea. *Estuarine Coastal and Shelf Science* 64: 467-474.
- Piazzì L, Balata D, Cecchi E, Cinelli F (2003) Co-occurrence of *Caulerpa taxifolia* and *C-racemosa* in the Mediterranean Sea: interspecific interactions and influence on native macroalgal assemblages. *Cryptogamie Algologie* 24: 233-243.
- Piazzì L, Ceccherelli G (2006) Persistence of biological invasion effects: Recovery of macroalgal assemblages after removal of *Caulerpa racemosa* var. *cylindracea*. *Estuarine Coastal and Shelf Science* 68: 455-461.
- Piazzì L, Ceccherelli G, Cinelli F (2001b) Threat to macroalgal diversity: effects of the introduced green alga *Caulerpa racemosa* in the Mediterranean. *Marine Ecology-Progress Series* 210: 149-159.

Referencias bibliográficas

- Piazzzi L, Cinelli F (1999) Development and seasonal dynamics of a population of the tropical alga *Caulerpa racemosa* (Forsskal) J. Agardh in the Mediterranean. *Cryptogamie Algologie* 20: 295-300.
- Piazzzi L, Cinelli F (2001) Distribution and dominance of two introduced turf-forming macroalgae on the coast of Tuscany, Italy, northwestern Mediterranean Sea in relation to different habitats and sedimentation. *Botanica Marina* 44: 509-520.
- Pinnegar JK, Polunin NVC (2000) Contributions of stable-isotope data to elucidating food webs of Mediterranean rocky littoral fishes. *Oecologia* 122: 399-409.
- Pohnert G, Jung V (2003) Intracellular compartmentation in the biosynthesis of caulerpenyne: Study on intact macroalgae using stable-isotope-labeled precursors. *Organic Letters* 5: 5091-5093.
- Poppe GT, Goto Y (1991) *European Seashells Vol I*, Wiesbaden, Germany.
- Poppe GT, Goto Y (1993) *European Seashells Vol II*, Hackenheim, Germany.
- Porte C, Escartin E, García de la Parra LM, Biosca X, Albaigés J (2002) Assessment of coastal pollution by combined determination of chemical and biochemical markers in *Mullus Barbatulus*. *Marine Ecology-Progress Series* 235: 205-216.
- Pou S, Ballesteros E, Delgado O, Grau AM, Riera F, Weitzmann B (1993) Sobre la presencia del alga *Caulerpa taxifolia* (Vahl) C. Agardh (Caulerpales, Chlorophyta) en aguas costeras de Mallorca. *Bolletí Societat d'Història Natural de les Illes Balears* 36: 83-90.
- Prohaska JR (1980) The glutathione peroxidase activity of glutathione S-transferases. *Biochim Biophys Acta* 611: 87-98.
- Garcia-Raso JE (1990) Study of a Crustacea-Decapoda Taxocoenosis of *Posidonia oceanica* Beds from the Southeast of Spain. *Marine Ecology-Pubblicazioni Della Stazione Zoologica Di Napoli I* 11: 309-326.
- Garcia-Raso JEG, delaRosa IL, Rosales JM (1996) Decapod crustacean communities from calcareous seaweed and *Posidonia oceanica* (rhizome stratum) in shallow waters. *Ophelia* 45: 143-158.
- Regoli F (2000) Total oxyradical scavenging capacity (TOSC) in polluted and translocated mussels: a predictive biomarker of oxidative stress. *Aquatic Toxicology* 50: 351-361.
- Relini G, Relini M, Torchia G (1998) Fish biodiversity in a *Caulerpa taxifolia* meadow in the Ligurian Sea. *Italian Journal of Zoology* 65: 465-470.

Referencias bibliográficas

- Relini G, Relini M, Torchia G (2000) The role of fishing gear in the spreading of allochthonous species: the case of *Caulerpa taxifolia* in the Ligurian Sea. *Ices Journal of Marine Science* 57: 1421-1427.
- Rueda JL, Fernandez-Casado M, Salas C, Gofas S (2001) Seasonality in a taxocoenosis of molluscs from soft bottoms in the Bay of Cadiz (southern Spain). *Journal of the Marine Biological Association of the United Kingdom* 81: 903-912.
- Rueda JL, Salas C (2003) Seasonal variation of a molluscan assemblage living in a *Caulerpa prolifera* meadow within the inner Bay of Cadiz (SW Spain). *Estuarine Coastal and Shelf Science* 57: 909-918.
- Ruiz GM, Carlton JT, Grosholz ED, Hines AH (1997) Global invasions of marine and estuarine habitats by non-indigenous species: Mechanisms, extent, and consequences. *American Zoologist* 37: 621-632.
- Russo GF, Frascetti S, Terlizzi A (2002) Population ecology and production of *Bittium latreillii* (Gastropoda, Cerithidae) in a *Posidonia oceanica* seagrass bed. *Italian Journal of Zoology* 69: 215-222.
- Sakai AK, Allendorf FW, Holt JS, Lodge DM, Molofsky J, With KA, Baughman S, Cabin RJ, Cohen JE, Ellstrand NC, McCauley DE, O'Neil P, Parker IM, Thompson JN, Weller SG (2001) The population biology of invasive species. *Annual Review of Ecology and Systematics* 32: 305-332.
- San Martin G (2003) *Annelida Polychaeta II, Syllidae*, Madrid.
- Sanchez-Jerez P, Barbera-Cebrian C, Ramos-Espla A (1999a) Daily vertical migrations in the epifauna associated with *Posidonia oceanica* meadows. *Journal of the Marine Biological Association of the United Kingdom* 79: 971-977.
- Sanchez-Jerez P, Barbera-Cebrian C, Ramos-Espla AA (2000) Influence of the structure of *Posidonia oceanica* meadows modified by bottom trawling on crustacean assemblages: comparison of amphipods and decapods. *Scientia Marina* 64: 319-326.
- Sanchez-Jerez P, Cebrian CB, Espla AAR (1999b) Comparison of the epifauna spatial distribution in *Posidonia oceanica*, *Cymodocea nodosa* and unvegetated bottoms: Importance of meadow edges 20: 391-405.
- Sanchez-Moyano JE, Estacio FJ, Garcia-Adiego EM, Garcia-Gomez JC (2001a) Effect of the vegetative cycle of *Caulerpa prolifera* on the spatio-temporal variation of invertebrate macrofauna. *Aquatic Botany* 70: 163-174.

Referencias bibliográficas

- Sanchez-Moyano JE, Garcia-Adiego EM, Estacio FJ, Garcia-Gomez JC (2001b) Influence of the density of *Caulerpa prolifera* (Chlorophyta) on the composition of the macrofauna in a meadow in Algeciras Bay (southern Spain). *Ciencias Marinas* 27: 47-71.
- Sanchez-Moyano JE, Moreno D, Rueda JL, Garcia-Raso JE, Salas C, Gofas S (2004) Las praderas de *Caulerpa prolifera*. In: Ambiente CdM (ed) Praderas y bosques marinos de Andalucía. Junta de Andalucía, Sevilla, pp 239-249.
- Sayed I, Parvez S, Pandey S, Bin-Hafeez B, Haque R, Raisuddin S (2003) Oxidative stress biomarkers of exposure to deltamethrin in freshwater fish, *Channa punctatus* Bloch. *Ecotoxicology and Environmental Safety* 56: 295-301.
- Scipione MB, Gambi MC, Lorenti M, Russo GF, Zupo V (1996) Vagile fauna of the leaf stratum of *Posidonia oceanica* and *Cymodocea nodosa* in the Mediterranean Sea. In: Kuo J, Phillips CP, Walker ID, Kirkman H (eds) Seagrass biology, Rottnest Island, Western Australia, pp 249-260.
- Schwede JG, Cardellina JH, Grode SH, James TR, Blackman AJ (1987) Distribution of the Pigment Caulerpin in Species of the Green-Alga *Caulerpa*. *Phytochemistry* 26: 155-158.
- Shi H, Sui Y, Wang X, Luo Y, Ji L (2005) Hydroxyl radical production and oxidative damage induced by cadmium and naphthalene in liver of *Carassius auratus*. *Comparative Biochemistry and Physiology part C Toxicology and Pharmacology* 140: 115-121.
- Sole M, Porte C, Biosca X, Mitchelmore CL, Chipman JK, Livingstone DR, Albaiges J (1996) Effects of the "Aegean Sea" oil spill on biotransformation enzymes, oxidative stress and DNA-Adducts in digestive gland of the mussel (*Mytilus edulis* L). *Comparative Biochemistry and Physiology C-Pharmacology Toxicology & Endocrinology* 113: 257-265.
- Streftaris N, Zenetos A (2006) Alien Marine Species in the Mediterranean - the 100 'Worst Invasives' and their impact. *Mediterranean marine Science* 7/1: 87-118.
- Streftaris N, Zenetos A, Papathanassiou E (2005) Globalisation in marine ecosystems: The story of non-indigenous marine species across European seas *Oceanography and Marine Biology - an Annual Review*, Vol. 43, pp 419-453.
- Sureda A, Box A, Deudero S, Pons A (2007) Protective response of *Caulerpa taxifolia* under intense herbivore pressure. In: CIESM (ed) *Rapp. Comm. int. Mer Médit*, Istanbul, pp 608.

Referencias bibliográficas

- Sureda A, Box A, Deudero S, Pons A (2008) Reciprocal effects of caulerpenyne and intense herbivorism on the antioxidant response of *Bittium reticulatum* and *Caulerpa taxifolia*. *Ecotoxicology and Environmental Safety* in press: doi:10.1016/j.ecoenv.2007.1012.1007.
- Sureda A, Box A, Ensenat M, Alou E, Tauler P, Deudero S, Pons A (2006) Enzymatic antioxidant response of a labrid fish (*Coris julis*) liver to environmental caulerpenyne. *Comparative Biochemistry and Physiology part C Toxicology and Pharmacology* 144: 191-196.
- Templado J (1984) Las praderas de *Posidonia oceanica* en el sureste español y su biocenosis. In: Boudouresque CF, Jeudy De Grissac A, Olivier J (eds) 1st International Workshop on *Posidonia oceanica* beds. G.I.S Posidonie publications, France, pp 159-172.
- Templado J, Ballesteros E, Garcia-Raso JE, San Martin GA, Lopez-Garcia L, Salas C, Luque A, Sanchez-Lizaso JL, Moreno D (2004) La comunidad posidonícola. In: Luque del Villar AA, Templado J (eds) Praderas y Bosques Marinos de Andalucía. Consejería de Medio Ambiente, Junta de Andalucía, Sevilla.
- Terrados J, Ros J (1995) Temporal Variation of the Biomass and Structure of *Caulerpa prolifera* (Forsskal) Lamouroux Meadows in the Mar Menor Lagoon (Se Spain). *Scientia Marina* 59: 49-56.
- Thibaut T, Meinesz A (2000) Are the Mediterranean ascoglossan molluscs *Oxynoe olivacea* and *Lobiger serradifalci* suitable agents for a biological control against the invading tropical alga *Caulerpa taxifolia*? *Comptes Rendus De L Academie Des Sciences Serie III-Sciences De La Vie-Life Sciences* 323: 477-488.
- Thibaut T, Meinesz A, Amade P, Charrier S, De Angelis K, Ierardi S, Mangialajo L, Melnick J, Vidal V (2001) *Elysia subornata* (Mollusca) a potential control agent of the alga *Caulerpa taxifolia* (Chlorophyta) in the Mediterranean Sea. *Journal of the Marine Biological Association of the United Kingdom* 81: 497-504.
- Thibaut T, Meinesz A, Coquillard P (2004) Biomass seasonality of *Caulerpa taxifolia* in the Mediterranean Sea. *Aquatic Botany* 80: 291-297.
- Tippets K (2002) The effects of *Caulerpa taxifolia* on invertebrate abundance in Agua Hedionda Lagoon, California.
- Todorova VK, Harms SA, Kaufmann Y, Luo S, Luo KQ, Babb K, Klimberg VS (2004) Effect of dietary glutamine on tumor glutathione levels and apoptosis-related

Referencias bibliográficas

- proteins in DMBA-induced breast cancer of rats. *Breast Cancer Research Treatments* 88: 247-256.
- Travizi A, Zavodnik N (2004) Phenology of *Caulerpa taxifolia* and temporal dynamics of its epibiotic meiofauna in the port of Malinska (Croatia, northern Adriatic Sea). *Scientia Marina* 68: 145-154.
- Trowbridge CD (2004) Emerging associations on marine rocky shores: specialist herbivores on introduced macroalgae. *Journal of Animal Ecology* 73: 294-308.
- Uchimura K, Nagasaka A, Hayashi R, Makino M, Nagata M, Kakizawa H, Kobayashi T, Fujiwara K, Kato T, Iwase K, Shinohara R, Kato K, Itoh M (1999a) Changes in superoxide dismutase activities and concentrations and myeloperoxidase activities in leukocytes from patients with diabetes mellitus. *J Diabetes Complications* 13: 264-270.
- Uchimura M, Sandeaux R, Larroque C (1999b) The enzymatic detoxifying system of a native Mediterranean Scorpio fish is affected by *Caulerpa taxifolia* in its environment. *Environmental Science & Technology* 33: 1671-1674.
- Valavanidis A, Vlahogianni T, Dassenakis M, Scoullou M (2006) Molecular biomarkers of oxidative stress in aquatic organisms in relation to toxic environmental pollutants. *Ecotoxicology and Environmental Safety* 64: 178-189.
- Vanalstyne KL (1988) Herbivore Grazing Increases Polyphenolic Defenses in the Intertidal Brown Alga *Fucus-Distichus*. *Ecology* 69: 655-663.
- Verlaque M (2001) Checklist of the macroalgae of Thau Lagoon (Hérault, France), a hot spot of marine species introduction in Europe. *Oceanologica Acta* 24: 29-49
- Verlaque M, Afonso-Carrillo J, Gil-Rodríguez MC, Durand C, Boudouresque CF, Le Parco Y (2004) Blitzkrieg in a marine invasion: *Caulerpa racemosa* var. *cylindracea* (Bryopsidales, Chlorophyta) reaches the Canary Islands (north-east Atlantic). *Biological Invasions* 6: 269-281.
- Verlaque M, Boudouresque CF, Meinesz A, Gravez V (2000) The *Caulerpa racemosa* complex (Caulerpales, Ulvophyceae) in the Mediterranean Sea. *Botanica Marina* 43: 49-68.
- Verlaque M, Durand C, Huisman JM, Boudouresque CF, Le Parco Y (2003) On the identity and origin of the Mediterranean invasive *Caulerpa racemosa* (Caulerpales, Chlorophyta). *European Journal of Phycology* 38: 325-339.

Referencias bibliográficas

- Verlaque M, Fritayre P (1994) Mediterranean algal communities are changing in the face of the invasive alga *Caulerpa taxifolia* (Vahl). *Oceanologica Acta* 17: 659-672.
- Viéitez JM, Alós C, Parapar J, Besteiro C, Moreira J, Núñez J, Laborda AJ, San Martín G (2004) *Annelida Polychaeta I*. Consejo Superior de Investigaciones Científicas, Madrid.
- Waldbusser GG, Marinelli RL (2006) Macrofaunal modification of porewater advection: role of species function, species interaction, and kinetics. *Marine Ecology-Progress Series* 311: 217-231.
- Winston GW, Digiulio RT (1991) Prooxidant and Antioxidant Mechanisms in Aquatic Organisms. *Aquatic Toxicology* 19: 137-161.
- York PH, Booth DJ, Glasby TM, Pease BC (2006) Fish assemblages in habitats dominated by *Caulerpa taxifolia* and native seagrasses in south-eastern Australia. *Marine Ecology-Progress Series* 312: 223-234.
- Zariquiey R (1968) *Crustáceos Decápodos Ibéricos*. Consejo Superior de Investigaciones Científica, Patronato Juan de la Cierva, Barcelona.
- Zenetos A, Gofas S, Russo GF, Templado J (2003) *CIESM Atlas of Exotic Species in the Mediterranean, Volume 3: Mollusc*. CIESM Publishers, Monaco.
- Zuljevic A, Antolic B, Onofri V (2003) First record of *Caulerpa racemosa* (Caulerpales : Chlorophyta) in the Adriatic Sea. *Journal of the Marine Biological Association of the United Kingdom* 83: 711-712.

